



Pentax DSI-200 Series Frequency Inverter



User's Manual

Foreword

Thank you for using the Pentax DSI-200 series of high-performance vector inverter. This guide explains how to properly use DSI-200 series inverter. Before using (installation, operation, maintenance, inspection, etc.), be sure to carefully read the instructions. Understanding of product safety precautions before using this product.

General notes
<ul style="list-style-type: none">● This manual due to product improvement, specifications change, as well as to the instructions of their ease of use will be appropriate changes. We will update the information number of instructions, issued a revised edition.● This icon in the instructions with the products you ordered may be different, please refer to the specific documentation for products supplied.● Due to damage to or loss need to order the manual, please contact OULU or OULU agents to order it as per the information number on the cover.

When get the product, please read following :

Items	Ensure way
And the order of the types of goods, models are consistent	Please confirm the DSI-200 side of the brand name
Whether there are parts damaged or damaged	Check the overall appearance and check for damage in shipping
Screws and other fastening parts are loose	If necessary, check with a screwdriver
Brochures, warranty cards and other accessories	DSI-200 manual and corresponding accessories

1. Definition of security

In this manual, safety issues are divided into the following two categories:

 **Warning:** Due to the dangers posed against the required operation, may result in serious injury and even death.

 **Caution:** Due to the dangers posed against the required operation, may lead to moderate harm or minor injuries, and damage to the equipment.

Installation, commissioning and maintenance of the system, please carefully read this chapter (safety precautions), follow the required safety precautions to operate. In case of any injuries and losses caused as a result of illegal operations that is nothing to do with OULU.

1.1 Safety precautions

Before Installation

 Warning
<ul style="list-style-type: none">● Do not install inverter finding the control system with water in, or inverter with missing parts or damaged parts.● Please do not install inverter when the packing list is not consistent with the physical name.

 Caution
<ul style="list-style-type: none">● Carefully handled when loading, otherwise it may damage the inverter.● Please don't use the damaged driver or missing parts inverter, there may be risk of injury.● Do not touch components of the control system, otherwise it will cause danger of static electricity.

During Installation

 Warning
<ul style="list-style-type: none">● Mount the inverter on incombustible surface like metal, and keep away from flammable substances. Otherwise it may cause fire.● Do not twist the mounting bolt of the equipment, especially the screw bolt marked in RED.

 Caution
<ul style="list-style-type: none">● Do not drop the conducting wire stub or screw into the inverter. Otherwise, it may cause damage to the inverter.● Please install the inverter at the place of less direct sunlight and vibration.● Please mind the location of its installation when more than two inverters are installed in one cabinet, so that radiation effect is promised.

During Wiring

 Warning
<ul style="list-style-type: none">● Operation shall be performed by the professional engineering technician.

Otherwise there will be unexpected danger.

- There shall be circuit breaker between the inverter and power supply. Otherwise, there may be fire.
- Make sure the power is disconnected prior to the connection. Otherwise there will be danger of electric shock.
- The earth terminal shall be earthed reliably. Otherwise there may be danger of electric shock.



Caution

- Never connect the input power supply to the output terminals (U, V, W) of the inverter. Note the terminal mark, do not connect the wrong line! Otherwise the drive is damaged!
- Please refer to the manual for the wire diameter. Otherwise there may be an accident!
- Never stop the braking resistor directly between the DC bus (+) and (-) terminals. Otherwise cause a fire!
- Encoder must use shielded wire, and the shield must ensure that the single-ended reliable grounding!

Before Power-on



Warning

- Please confirm whether the power voltage class is consistent with the rated voltage of the inverter and the Input terminal (R、S、T) and Output terminal(U、V、W)cable connecting positions are correct, and check whether the external circuit is short circuited and whether the connecting line is firm, otherwise it may damage the inverter.
- Do not frequently turn ON/OFF power .If continuously ON/OFF power is needed, please make sure the time interval more than 1 minute.



Caution

- The cover must be well closed prior to the inverter power-on. Otherwise electric shock may be caused!
- All the external fittings must be connected correctly in accordance with the circuit provided in this manual. Or accident may occur.

Upon Power-on





Warning

- Do not open the cover of the inverter upon power-on. Otherwise there will be danger of electric shock!
- Do not touch the inverter and its surrounding circuit with wet hand. Otherwise there will be danger of electric shock.
- Do not touch the inverter terminals (including control terminal). Otherwise there will be danger of electric shock.
- At power-on, the inverter will perform the security check of the external strong current circuit automatically. Thus, at this time please do not touch the terminals U,V,W, or the terminals of motor, otherwise there will be danger of electric shock.

 Caution
<ul style="list-style-type: none"> ● If the parameter identification is required, pay attention to the danger of injury arising from the rotating motor. Otherwise accident may occur. ● Do not change the factory settings at will. Otherwise it may damage the equipment.

During the Operation

 Warning
<ul style="list-style-type: none"> ● Do not touch the fan, heat sink or discharge resistor to sense the temperature. Otherwise, you may get burnt. ● Detection of signals during the operation shall only be conducted by qualified technician. Otherwise, personal injury or equipment damage may be caused.

 Caution
<ul style="list-style-type: none"> ● Do not control run/stop by using contactor. Or equipment damage may be caused! ● Avoid anything falling into the equipment when inverter is running. Or damage may be caused.

Maintenance

 Warning
<ul style="list-style-type: none"> ● Do not perform professional training personnel Do not carry out maintenance and maintenance of the inverter. Otherwise it is personal injury or equipment damage! ● Do not charge the equipment for repair and maintenance. Otherwise there is danger of electric shock! ● After confirming that the input power of the inverter is de-energized for 10 minutes, the drive can be maintained and serviced. Otherwise the residual charge on the capacitor will cause harm to people! ● All pluggable plug-ins must be plugged in the case of power failure! ● After the Inverter is replaced, the parameters must be set and checked.

2. Product Information

2.1 Name rule

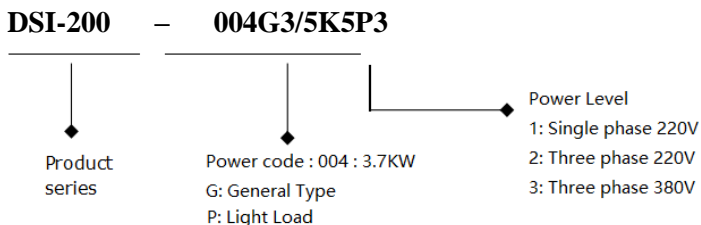

Figure 2-1 Name rule

2.2 Nameplate specification

<p>Variable Frequency Inverter MODEL: DSI-200-004G3/5K5P3 POWER: 4Kw / 5.5 Kw INPUT: 3PH 400V~ 10.5A 50Hz/60Hz OUTPUT: 3PH 0-400V~ 9A 50HZ/60HZ Pentax Inverter</p>
--

Figure 2-2 Nameplate

2.3 DSI-200 Inverter product series

Model	Power KVA	Input current A	Output current A	Match motor KW
Single-phase:220V,50/60Hz				
DSI-200-K40G1	1.0	5.4	2.3	0.4
DSI-200-K75G1	1.5	8.2	4.0	0.75
DSI-200-1K5G1	3.0	14.0	7.0	1.5
DSI-200-2K2G1	4.0	23.0	9.6	2.2
Three-phase:380V,50/60Hz				
DSI-200-K75G3	1.5	3.4	2.1	0.75
DSI-200-1K5G3	3.0	5.0	3.8	1.5
DSI-200-2K2G3	4.0	5.8	5.1	2.2
DSI-200-004G3/5K5P3	5.9	10.5	9.0	3.7
DSI-200-5K5G3/7K5P3	8.9	14.6	13.0	5.5

2.4 Technical data

Item		Specification
Basic function	Maximum frequency	Vector control: 0~500Hz; V/F control: 0~500Hz
	Carrier frequency	0.8kHz-12kHz the carrier frequency can be adjusted automatically according to the load characteristics.
	Input frequency resolution	Digital setting: 0.01Hz Analog setting: Maximum frequency × 0.025%
	Control mode	without PG Vector(SVC),Feedback vector(FVC) and V/F control
	Start torque	G type: 0.5Hz/150% (SVC) ; 0Hz/180% (FVC)

Item		Specification	
		P type: 0.5Hz/100%	
Speed range	1: 100 (SVC)	1: 1000 (FVC)	
Speed control accuracy	±0.5% (SVC)	±0.02% (FVC)	
Torque control accuracy	±5% (FVC)		
Overload capacity	G type: 150% rated current 60sec; 180% rated current 3sec P type: 120% rated current 60sec; 150% rated current 3sec		
Torque boost	Auto-torque boost; manual torque boost 0.1%~30.0%		
V/F curve	Three types: linear type; Multi-point type; the nth power of V/F curve		
V/F separation	Two types: full separation, half of separation		
ACC/DEC curve	Linear or S curve of ACC/DEC ways. Four types of ACC/DEC Time, ACC/DEC time range is 0.0~6500.0s		
DC brake	DC brake frequency: 0.00Hz~ max frequency, brake time: 0.0s~36.0s,brake action current: 0.0%~100.0%		
JOG Control	JOG frequency range: 0.00Hz~50.00Hz. JOG speed-up/down time: 0.0s~6500.0.s		
Simple PLC, multi-stage speed running	Via built-in PLC or control terminal can realize max 16 stage speed running		
Built-in PID	Can realize process control close-loop system conveniently		
Auto-adjust voltage (AVR)	When grid voltage changes, can keep output voltage steadily automatically		
Over current and over voltage speed control	During running, limit current and voltage automatically, protect from tripping off frequently for over voltage and over current.		
Quick current-limit function	Reduce over current error on max extent, protect inverter normal running		
Torque limitation and control	“Digger” feature, inverter could limit torque automatically, prevent over current tripping off; close-loop vector can realize torque control.		
Personable function	Outstanding perform	Using high-perform current vector control	
	Instance stop not stop	During instant power-off, by motor feedback energy, inverter compensates voltage-drop to keep running for short time.	
	Quick current-limit function	Reduce over current error on max extent	

		Item	Specification
		Timing control	timing control function: setting time range: 0.0min~6500.0min
		Multi-motor switch	2sets of motor parameter, can realize 2motors switching control
		Multi-threading bus support	Support multiple fieldbus: Modbus, RS85, CAN open, CAN link
		Multi-encoder support	Support differential, open collector, rotary transformer
		Command source	control panel, control terminal, communication; can be switched by several modes
		Frequency source	10 types of frequency sources: digital setting, analog voltage setting, analog current setting, pulse setting, communication setting, can be switched by several methods
		Auxiliary frequency sources	10 types of auxiliary frequency source, can realize auxiliary frequency trimming, frequency combining flexibility
Running		Input terminal	Standard: 7 digital input terminal, one of them support max 100KHz HS pulse input;3 analog input terminal, one of them support 0~10V voltage input, one support 0~10V voltage or 0/4~20mA current input, One support -10~+10V voltage.
		Output terminal	Standard: 1 high-speed pulse output terminal(optional open collector),support 0~100kHzpulse 1 digit output terminals; 2 relay output terminal 2 analog output terminals, one of them support 0~20mA current output;
Display and keypad		LED display	Can display parameter
		Press-key locking and function selection	Realize press-key partial or full locking, define part press-key function range, to avoid wrong operation
		Protection function	Power-on motor short circuit test, output phase-loss protection, over-current protection, over-voltage protection, under-voltage protection, overheat protection, overload protection etc.

Item		Specification
	Optional parts	Differential PG card, open collector PG card, OC input PG card
Environment	Application site	Indoor, without direct sunlight, no powder, corrosive gas, combustion air, oil dust, water steam, water drop or salt etc.
	Altitude level	Less than 1000m
	Environment temperature	-10°C~+40°C (During 40°C~50°C, please reduce capacity use)
	Humidity	<95% RH, no water drop condensed
Optional	Two Panel LED display	LED display; using RJ45 port to connect
	LCD panel	LED display; could parameter copy

2.5 Schematic diagram of the dimensions of the inverter

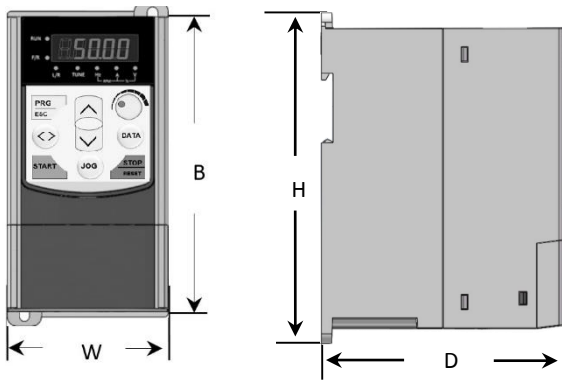

Figure 2-4 Schematic diagram of the dimensions of the inverter

2.6.1 Mechanical data and specifics

2.6.2 Keypad size DSI-200

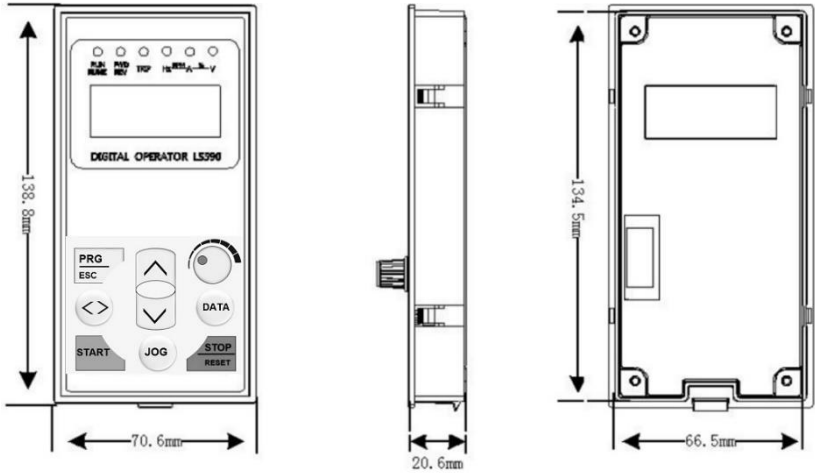

Figure 2-5 Keyboard Operator Outline and Installation Dimensional Drawings

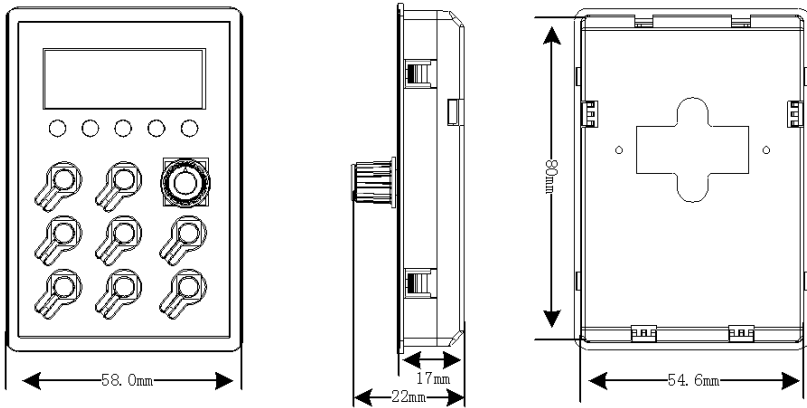

Figure 2-6 Keyboard Operator Outline and Installation Dimensional Drawings

2.5.1 Mechanical

Model Type	Outsize (mm)				Install hole
	B	W	H	D	
DSI-200-K40G1	155	84	170	127	Φ5.7
DSI-200-K75G1					
DSI-200-1K5G1					
DSI-200-2K2G1					
DSI-200-K75G3					

Model Type	Outsize (mm)				Install hole
	B	W	H	D	
DSI-200-1K5G3					
DSI-200-2K2G3					
DSI-200-004G3/5K5P3	183	91	193	142	Φ4.7

2.5.2 Operation panel shape

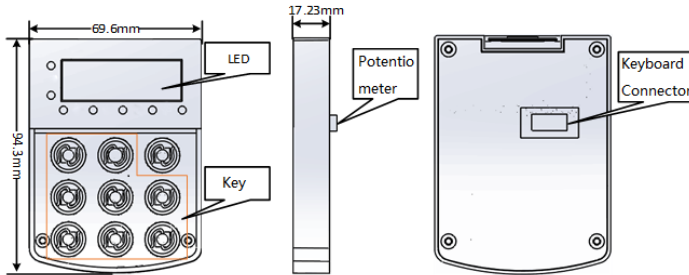

2.5.3 Shape and size of the panel tray

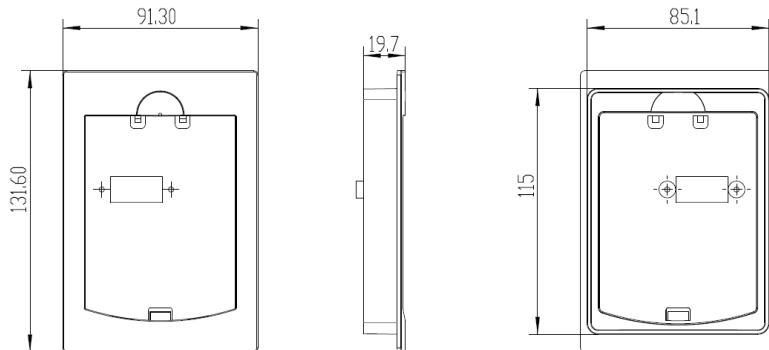

2.6 The daily maintenance and maintenance of the inverter

2.6.1 Daily Maintenance

In order to avoid faults of the frequency converter, ensure the normal operation of equipment and prolong the service life of the frequency converter, daily maintenance is necessary for the frequency converter.

Examine Items:

- 1) Whether the sound in the motor running abnormal changes

- 2) Whether or not vibration is generated during motor operation
- 3) Whether the inverter installation environment has changed
- 4) Whether the inverter cooling fan is working properly
- 5) Whether the inverter overheating

Daily cleaning:

- 1) Always keep the drive in a clean state.
- 2) Effectively remove the dust on the surface of the inverter to prevent dust into the inverter inside. Especially metal dust.
- 3) Effectively remove the inverter cooling fan oil.

2.6.2 Regular Maintenance

Please check the place where you are difficult to check. Periodically check items:

- 1) Check the duct and clean it regularly
- 2) Check if the screws are loose
- 3) Check that the inverter is subject to corrosion
- 4) Check whether the terminal has a trailing mark
- 5) Main circuit insulation test

Reminder: When measuring the motor insulation resistance with a megger (please use a DC 500V megger), disconnect the main circuit from the inverter. Do not use insulation resistance meter to test the control circuit insulation. No need for high voltage test (factory completed)

2.6.3 Inverter replacement parts

Inverter parts are mainly cooling fan and filter electrolytic capacitors, the life and the use of the environment and maintenance are closely related. The general life time is:

Device Name	Life Time
Fan	2 ~ 3year
Electrolytic capacitor	4 ~ 5year

The user can determine the replacement age according to the run time.

1) Cooling fan

Possible cause of damage: bearing wear, leaf aging.

Criteria: fan blades, etc. whether there is cracks, whether the sound when the sound is abnormal vibration.

2) Filter electrolytic capacitors

Possible causes of damage: Poor input power quality, higher ambient temperature, frequent load transitions, and electrolyte aging. Criteria: whether the liquid leakage, safety valve has been protruding, the determination of electrostatic capacitance, insulation resistance determination.

2.6.4 Storage of the inverter

Users to buy the inverter, the temporary storage and long-term storage must pay attention to the following:

- 1) Stored in the original packaging as far as possible into the company's packaging.
- 2) Prolonged storage will lead to the deterioration of electrolytic capacitors, must ensure

that within 2 years through a power, power time of at least 5 hours, the input voltage must be slowly raised to the rated voltage regulator.

2.7 Guide for Selection of Brake Components

(*): Figure 2-1 is the guide data, the user can choose according to the actual situation of different resistance and power, (but the resistance must not be less than the recommended value in the table, the power can be large.) The choice of braking resistor The actual application of the motor power generation to determine the power, and system inertia, deceleration time, bit energy load and so have a relationship, the need for customers according to the actual situation. The greater the inertia of the system, the shorter the deceleration time required, the more frequent the braking, the greater the choice of the braking resistor, the smaller the resistance.

2.7.1 The choice of resistance

When braking, the regenerative energy of the motor is almost entirely consumed on the braking resistor. According to the formula: $U * U / R = P_b$

Formula U - System Brake Voltage for Stable Braking

(Different systems are not the same, for the 380VAC system generally take 700V)

P_b ---- brake power

2.7.2 Power selection of braking resistor

The braking power is theoretically the same as the brake power, but the derating is 70%.

According to the formula: $0.7 * P_r = P_b * D$

P_r - the power of the resistor

D ---- Brake frequency (regeneration process the proportion of the entire process)

Normal case	Elevator	Open and take	Centrifuge	accidental braking resistor	Normal use
Brake frequency value	20% ~30%	-20 ~30%	50%~60 %	-5%	10%

Model Type	Braking resistor Recommended power	Recommended resistance Recommended resistance	brake unit	Notes
DSI-200-K40G1	80W	$\geq 200\Omega$	Standard built-in	No special instructions
DSI-200-K75G1	80W	$\geq 150\Omega$		
DSI-200-1K5G1	100W	$\geq 100\Omega$		
DSI-200-2K2G1	100W	$\geq 70\Omega$		
DSI-200-K75G3	150W	$\geq 300\Omega$		
DSI-200-1K5G3	150W	$\geq 220\Omega$		
DSI-200-2K2G3	250W	$\geq 200\Omega$		
DSI-200004G3/5K5P3	300W	$\geq 130\Omega$		
DSI-2005K5G3/7K5P3	400W	$\geq 90\Omega$		

3. Mechanical and Electrical Installation

3.1 Mechanical Installation

3.1.1 Installation environment:

- 1) Ambient temperature: The ambient temperature has a great influence on the life of the inverter. Do not allow the operating temperature of the inverter to exceed the permissible temperature range (-10 °C ~ 40 °C).
- 2) Mount the inverter on the surface of the flame retardant and attach it to the mounting bracket vertically with screws. Inverter work easy to produce a lot of heat, there should be enough space around the heat.
- 3) Please install it where it is not easy to vibrate. Vibration should not be greater than 0.6G. Special attention away from the punch and other equipment.
- 4) To avoid the place in the direct sunlight, wet, there are drops of water.
- 5) To avoid installed in the air corrosive, flammable, explosive gas of the place.
- 6) To avoid the equipment in the oil, dust, dust and more places.

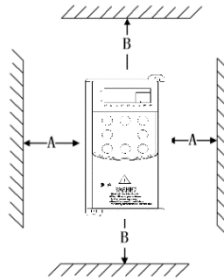

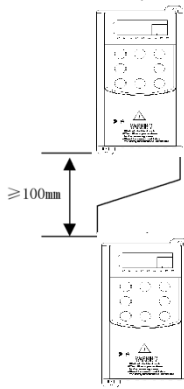

Figure 3-1 DSI-200 installation diagram

Unit installation: When the inverter power is not greater than 22kW cannot consider the A size. When greater than 22kW, A should be greater than 50mm. Up and down installation: Install the thermal insulation baffle when the inverter is installed up and down

Power level	Installment size	
	B	A
≤15kW	≥100mm	Not requirement
18.5Kw~30kW	≥200mm	≥50mm
≥37kW	≥300mm	≥50mm

3.1.2 Mechanical installation need to focus on the heat problem. So please note the following:

- 1) Please install the inverter vertically, so that the heat can be distributed upwards. But cannot be inverted. If the cabinet has more frequency converter, it is best to install side by side. Please refer to Figure 3-1 for the installation of the insulation baffle.
- 2) Installation space Follow the example shown in Figure 3-1 to ensure the cooling space of the inverter. However, please consider the layout of the cabinet when the heat dissipation of other devices.
- 3) The mounting bracket must be flame retardant.
- 4) For metal dust applications, it is recommended to install the radiator cabinet. At this time fully sealed cabinet space as much as possible.

3.2 Electrical Installation

3.2.1 Selection of external electrical components

Model	Empty open (MCCB) A	Recommend Contactor A	Recommended input side Main circuit lead wire mm ²	Recommended output side main Circuit wire mm ²	Recommended control circuit Wire mm ²
Single phase 220V					
DSI-200-K40G1	16	10	2.5	2.5	1.0
DSI-200-K75G1	16	10	2.5	2.5	1.0
DSI-200-1K5G1	20	16	4.0	2.5	1.0
DSI-200-2K2G1	32	20	6.0	4.0	1.0
Three phase 380V					
DSI-200-K75G3	10	10	2.5	2.5	1.0
DSI-200-1K5G3	16	10	2.5	2.5	1.0

Model	Empty open (MCCB) A	Recommend Contactor A	Recommended input side Main circuit lead wire mm ²	Recommended output side main Circuit wire mm ²	Recommended control circuit Wire mm ²
DSI-200-2K2G3	16	10	2.5	2.5	1.0
DSI-200-004G3/5K5P3	25	16	4.0	4.0	1.0
DSI-200-5K5G3/7K5P3	32	25	4.0	4.0	1.0

3.2.2 Connect with peripheral devices

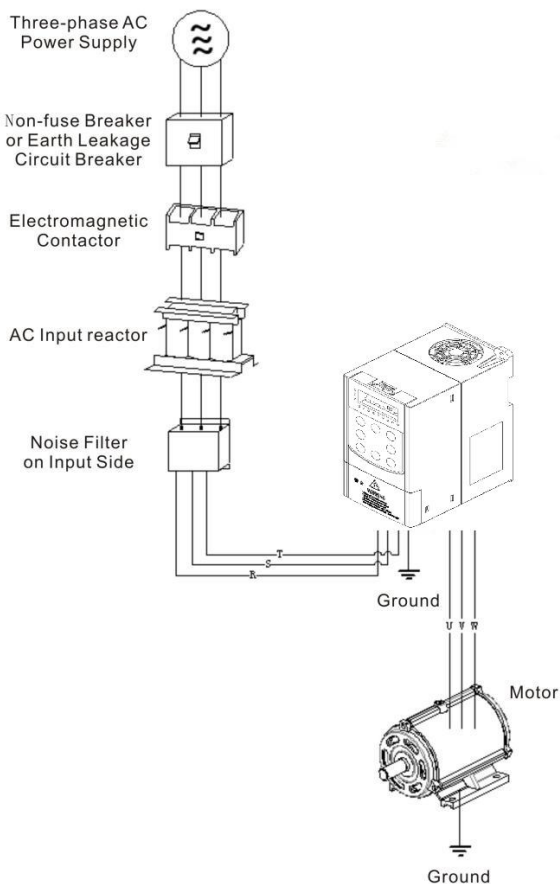

Figure 3-2 Connection to peripheral devices

3.2.3 Instructions for the use of external electrical components

Name	Setting station	Function
Air switch	Input the front of the loop	When the downstream device is over current, disconnect the power supply
Contactors	Empty and between the input side of the drive	The inverter should be operated up and down, and the frequency converter should be avoided by the contactor (Less than twice per minute) or direct start operation.
AC input Reactor	Inverter input side	Improve the input side of the power factor; effectively eliminate the input side of the high harmonics, to prevent the voltage waveform Distortion caused by other equipment damage; to
EMC AC output filter	Inverter input side	Reduce the conduction and radiation interference of the inverter to the outside; reduce the conduction from the power supply side to the inverter Interference, improve the anti-interference ability of the inverter.
DC Reactor	315G The above DC reactor is standard	Improve the input side of the power factor; improve the efficiency of the whole machine and thermal stability. Effectively eliminate the loss The impact of the high-order harmonic on the inverter, reducing external conduction and radiation interference.
AC output filter	Between the inverter output side and the motor. Close to the inverter installation.	Inverter output side generally contains more high-order harmonics. When the distance between the motor and the inverter, because the line There is a large distributed capacitance in the road. Where a harmonic may produce resonance in the loop, bringing two Aspect: ◆Damage to the motor insulation performance, long time will damage the motor. ◆produce a large leakage current, causing frequent protection of the inverter. General frequency converter and motor distance over 100m, it is recommended to install the output AC reactor.

3.3 Terminal block diagram

3.3.1 Description of Major Loop Terminal Block

a) The Major Loop Terminal Block Distribution Diagram of 0.4KW-5.5KW (as shown in

fig. 3-3a)

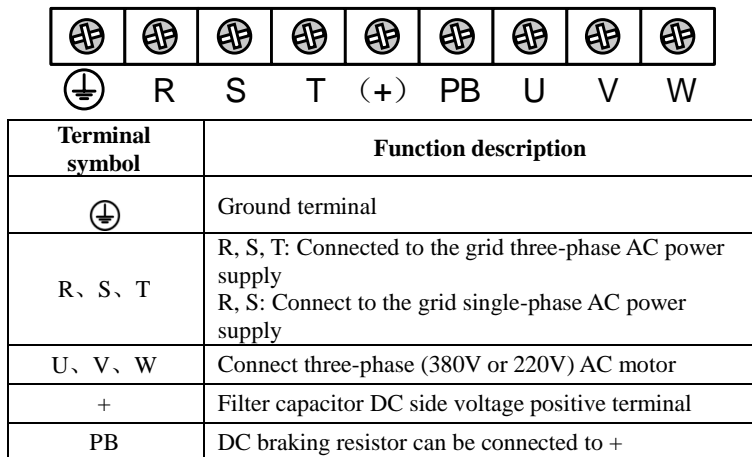

3.3.2 Terminals of Control Loop:

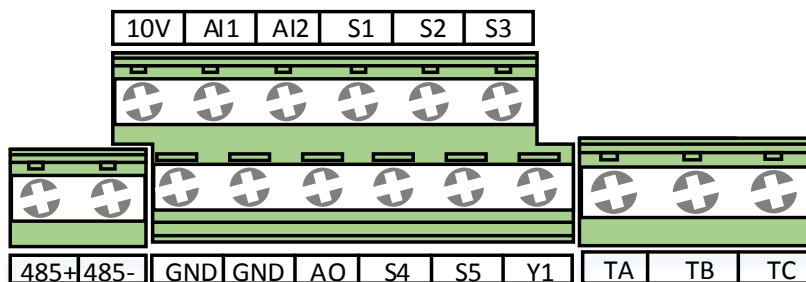

Fig. 3-4 Control Loop Wiring Terminal Diagram

3.4 Standard Wiring Diagram

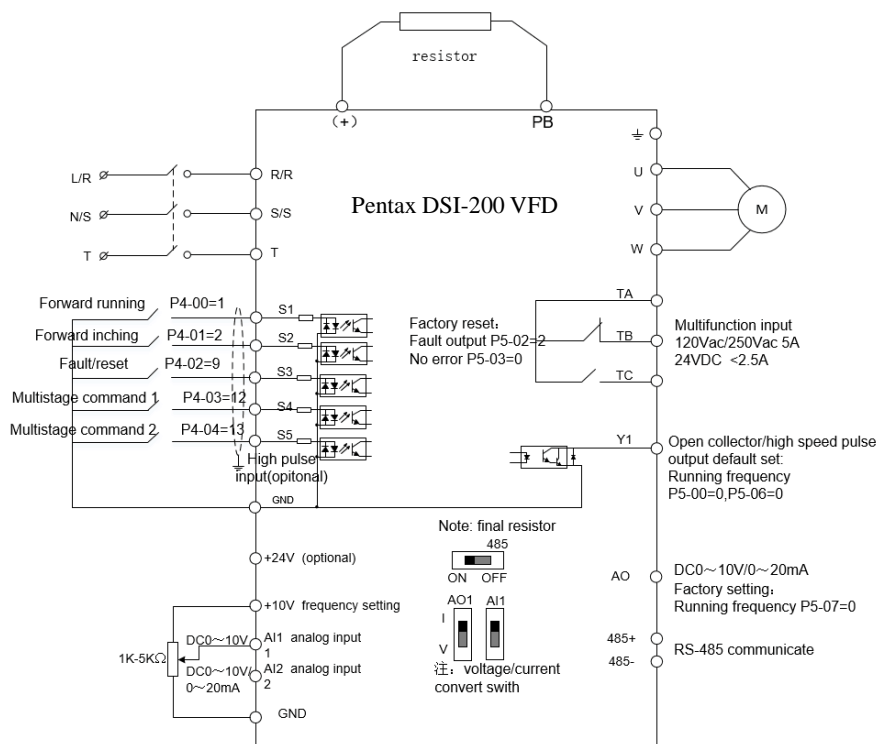

Figure 3-5 Standard wiring diagram

Terminal name	Function and description
S1 ~ S5	Multi-function digital input
+10V-GND	+10V power supply for this unit (current: 10mA)
AI1-GND AI2-GND	Analog input, voltage (0~10V) / current (0~20mA) can be selected through the motherboard Input impedance: 22kΩ (voltage input) / 250Ω (current input)
GND	Reference zero potential of +10V, input signal common
Y1	High-speed pulse or open collector output terminal, its corresponding common terminal is GND; output frequency range: 0~100 kHz
AO1	Analog output terminal, where AO1 can select voltage or current output through the DIP switch
TA-TB-TC	Relay output, TA common, TB normally closed, TC normally open; contact capacity: AC250V/3A, DC30V/1A

Terminal name	Function and description
485+, 485-	485 communication port, 485 differential signal positive and negative terminals, standard 485 communication interface, please use twisted pair or shielded cable

4. Operation Display and Application Examples

4.1 Operation and display interface

4.1.1 Panel diagram

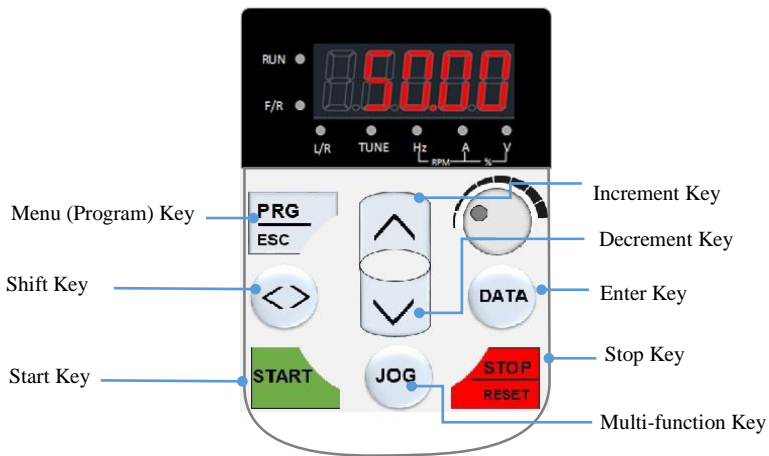





Figure 4-1 Operation panel









4.1.2 Keys on LED Operating Panel

Key	Key name	Key function
PRG	Programming	Enter or exit Level I menu. Return to the previous menu.
DATA	Confirm	Enter each level of menu interface. Confirm displayed parameter setting.
∧	UP Increment	Data or function code increase
∨	DOWN Decrement	Data or function code decrease

Key	Key name	Key function
< >	Shift key	In the shutdown display interface and run the display interface, you can cycle to select the display parameters; modify the parameters, you can select the parameters of the modified bit
RUN	RUN	Start the AC drive when using the operating panel control mode.
STOP	stop/reset	Stop the AC drive when the drive is in the RUNNING status, controlled by P7-02 Perform a reset operation when the drive is in the FAULT status.not control by P7-02
JOG	Quick multi-function key	as defined by the setting of P7-01

4.1.3 Lights

 Light is off,
  light is on,
  light flashes

Light statue	Statue Description
RUN/TUNE	 Light off : running
	 Light on : running
FWD/REV	 Light off : normal work
	 Light on : Reverse run
TRIP Self-learning / torque control / fault indicator	 Light off : normal work
	 Light on : Torque control
	 Slow flash : Motor self-learning (1 times/s)
	 Quick flash : error (4 times/s)

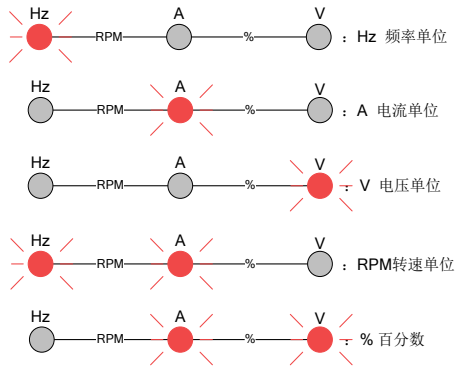

4.2 Function code view, modify method description

DSI-200 the operation panel of the inverter adopts the three-level menu structure to set the parameters and so on. The third level menu is: Function parameter group (level menu) → Function code (II level menu) → Function code setting value (III grade menu)

The operation flow is shown in Figure 4-2

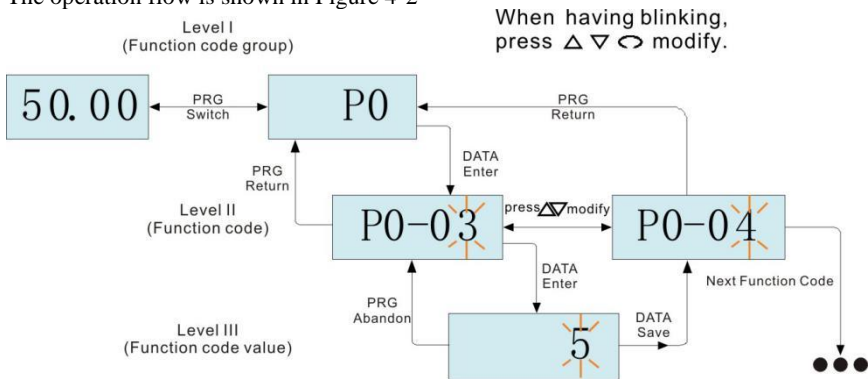

Figure 4-2 Three-level menu operation flow chart

Note: When operating in a three-level menu, press PRG or ENTER to return to the secondary menu. The difference between the two is: ENTER key will save the parameters after the return to the secondary menu, and automatically transferred to the next function code; and press the PRG key is straight back to the secondary menu, do not store parameters and return to the current function code

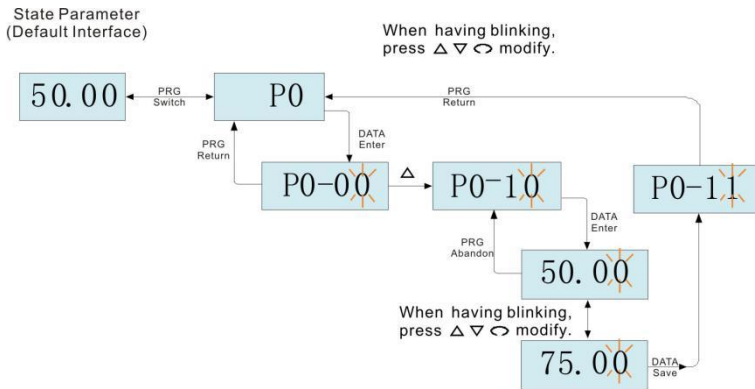

Figure 4-3

When operating in Level III menus, if the parameter does not include a flashing digit, then it is not possible to modify that parameter. There are two possible reasons for this:

- 1) The function parameter you have selected is read-only.
- 2) The displayed function parameter cannot be modified while the AC drive is in the RUNNING status. You can modify these types of parameter only when the AC drive is in the STOP status.

4.4 Inverter debugging flow chart

4.3.1. Inverter debugging flow chart

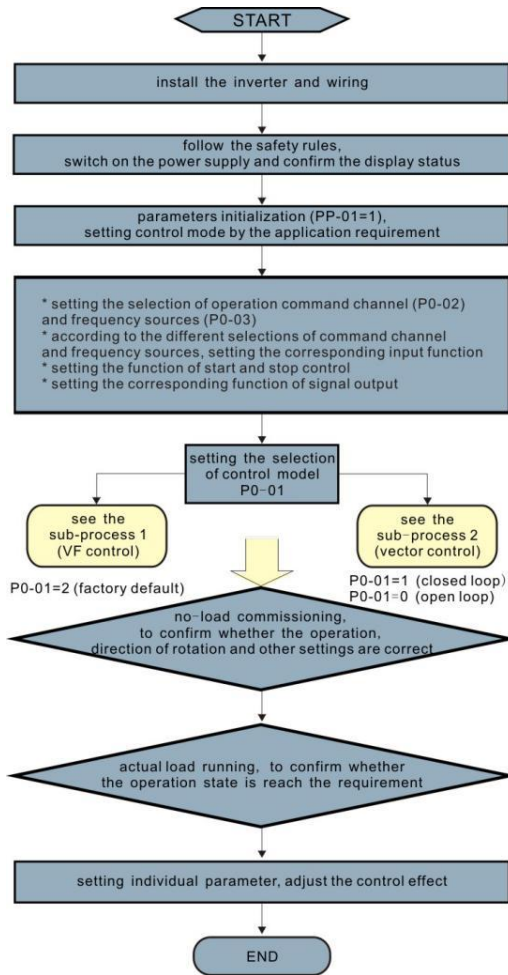

4.3.2 Inverter commissioning sub-flow chart 1

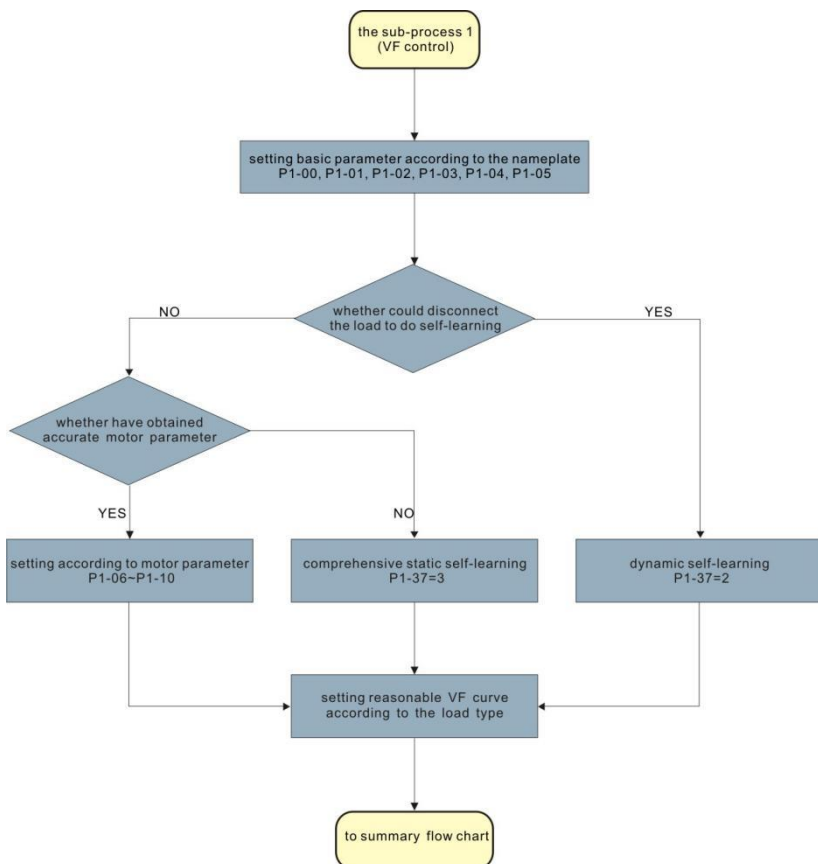

UN key on the keyboard panel to start the self-learning operation of the motor parameters.

5. Function Parameters Table

PP-00 is set to a non-zero value, that is, the parameter protection password is set. In the function parameter mode and the user changes the parameter mode, the parameter menu must enter the password correctly and cancel the password.

The parameter menu in user-defined parameter mode is not password protected.

P group, a group is the basic function parameters, d group is the monitoring function parameters. The symbols in the function table are described below:

"☆": indicates that the set value of the parameter is in the inverter is in shutdown, running state, can be changed;

"★": indicates that the set value of this parameter cannot be changed when the inverter is running;

"●": indicates that the value of the parameter is the actual detection record value, cannot be changed;

"*": Indicates that the parameter is "factory parameter", only the manufacturer settings, prohibit the user to operate;

5.1 basic function data

5.1 Data and specifics

Function Code	Name	Set Range	default	Alteration
P0 Basic Function Group				
P0-01	Motor 1 control mode	0: No speed sensor vector control (SVC) 1: Speed sensor vector control (FVC) 2: V / F control	2	★
P0-02	Command source selection	0: Operation panel instruction channel 1: Terminal command channel 2: communication command channel	0	☆
P0-03	Main frequency reference setting A channel selection	0: digital setting (preset frequency P0-08, UP / DOWN can be modified, power is not memory) 1: digital setting (preset frequency P0-08, UP / DOWN can be modified, power-down memory) 2: AI1 (Note: J4 jumper in the PANEL and AI1 connected to the keyboard potentiometer input, PORT and AI1 connected to the external terminal AI1 input) 3: AI2 4: AI3 5: High-speed pulse input setting (S5) 6: multi-segment instructions 7: Simple PLC 8: PID 9: communication given 10: Reserved	2	★
P0-04	Auxiliary frequency source B command input selection	With P0-03 (main frequency source A instruction input	0	★

P0-05	Auxiliary frequency source B Reference object selection	0: relative to maximum frequency 1: Relative to frequency source A	0	☆
P0-06	Auxiliary frequency source B command range	0% ~ 150%	100%	☆
Function Code	Name	Set Range	default	Alteration
P0-07	Frequency source combination mode selection	Bit: frequency source selection 0: Main frequency source A 1: main and auxiliary operation results (operation relationship determined by ten) 2: Main frequency source A and auxiliary frequency source B switch 3: Main frequency source A and master and slave operation result switching 4: auxiliary frequency source B and master and slave operation result switching Ten: frequency source main and auxiliary operation relationship 0: main + auxiliary 1: main - auxiliary 2: the two maximum 3: the two minimum	00	☆
P0-08	Preset frequency	0.00Hz ~ max frequency (P0- 10)	50.00Hz	☆
P0-09	Running direction	0 : same direction 1 : opposite direction	0	☆
P0-10	Max. frequency	50.00Hz ~ 500.00Hz	50.00Hz	★
P0-11	Setting channel of frequency upper limit	0: P0-12 is set 1: AI1 (Note: J6 jumper) 2: AI2 3: AI3 4: High-speed pulse setting (S5) 5: communication given	0	★
P0-12	Frequency reference upper limit	Upper limit P0-14 ~ max frequency P0-10	50.00Hz	☆
P0-13	Frequency reference upper limit offset	0.00Hz ~ max frequency P0-10	0.00Hz	☆

P0-14	Frequency reference lower limit	0.00 Hz to frequency upper limit P0-12	0.00Hz	☆
P0-15	Carrier frequency	0.8kHz ~ 12.0kHz	Model determined	☆
P0-16	Carrier frequency adjusted with temperature	0 : no 1 : yes	1	☆
P0-17	Acceleration time 1	0.00s ~ 65000s	Model determined	☆
P0-18	Deceleration time 1	0.00s ~ 65000s	Model determined	☆
P0-19	Acceleration/Deceleration time unit	0 : 1 S 1 : 0.1 S 2 : 0.01 S	1	★
P0-21	Frequency offset of Auxiliary frequency setting channel for main and auxiliary calculation	0.00Hz ~ max frequency P0-10	0.00Hz	☆
P0-22	Frequency reference resolution	2 : 0.01Hz	2	★
P0-23	Retentive of digital setting frequency upon stop	0: do not remember 1: memory	1	☆
P0-24	Motor parameter group selection	0: 1st motor parameter 1: 2nd motor parameter	0	★
P0-25	Acceleration/Deceleration time base frequency	0: maximum frequency (P0-10) 1: Set frequency 2 : 100Hz	0	★
Function Code	Name	Set Range	default	Alteration
P0-26	Base frequency for UP/DOW modification during running	0: Run frequency 1: Set frequency	0	★

P0-27	The run command is tied to the main frequency source A command selection :	Bit: Operation panel command Bind frequency source selection 0: no binding 1: Digital setting frequency 2: AI1 (Note: J6 jumper) 3: AI2 4: AI3 5: High-speed pulse input setting (S5) 6: multi-speed 7: Simple PLC 8: PID 9: communication given Ten: Terminal Command Binding Frequency Source Selection	0000	☆
P0-28	Serial port comms. protocol	0 : Modbus communication	0	☆
P1 Motor 1 Parameters				
P1-00	Motor type selection	0: Ordinary asynchronous motor 1: Variable frequency asynchronous motor	0	★
P1-01	Rated motor power	0.1kW ~ 1000.0kW	Model dependent	★
P1-02	Rated motor voltage	1V ~ 2000V	Model dependent	★
P1-03	Rated motor current	0.01 to 655.35 A (AC drive power ≤ 55 kW)	Model dependent	★
P1-04	Rated motor frequency	0.01Hz ~ Max frequency	Model dependent	★
P1-05	Rated motor speed	1rpm ~ 65535rpm	Model dependent	★
P1-06	Stator resistance	0.001Ω ~ 65.535Ω 0.0001Ω ~ 6.5535Ω	Auto-tuning dependent	★
P1-07	Rotor resistance	0.001Ω ~ 65.535Ω	Auto-tuning dependent	★
P1-08	Leakage inductive reactance	0.01mH ~ 655.35mH	Auto-tuning dependent	★
Function Code	Name	Set Range	default	Alteration

P1-09	Mutual inductive	0.1mH ~ 6553.5mH	Auto-tuning dependent	★
P1-10	No-load current	0.01A ~ P1-03	Auto-tuning dependent	★
P1-27	Encoder pulses	1 ~ 65535	1024	★
P1-30	A/B phase sequence of ABZ incremental encoder	0: Forward 1: Reserve	0	★
P1-36	Encoder wire-break fault detection time	0.0: no operation 0.1s ~ 10.0s	0.0s	★
P1-37	Motor auto-tuning method selection	0: no operation 1: Asynchronous machine static part of the parameters of self-learning 2: asynchronous machine dynamic complete self-learning 3: asynchronous machine static complete self-learning	0	★
P2 Vector Control Parameters				
P2-00	Speed loop proportional gain 1	1 ~ 100	30	☆
P2-01	Speed loop integral time 1	0.01s ~ 10.00s	0.50s	☆
P2-02	Switch over frequency 1	0.00 ~ P2-05	5.00Hz	☆
P2-03	Speed loop proportional gain 2	1 ~ 100	20	☆
P2-04	Speed loop integral time 2	0.01s ~ 10.00s	1.00s	☆
P2-05	Switch over frequency 2	P2-02 ~ max frequency(P0-10)	10.00Hz	☆
P2-06	SVC/FVC slip compensation gain	50% ~ 200%	100%	☆
P2-07	SVC Speed feedback filter time constant	0.000s ~ 0.100s	0.015s	☆

P2-09	Torque limit source in speed control	0: Function code P2-10 setting 1: AI1 2: AI2 3: AI3 4: High-speed pulse input setting (S5) 5: communication given 6: MIN (AI1, AI2) 7: MAX (AI1, AI2) 1-7 option full scale corresponds to P2-10	0	☆
P2-10	Digital setting of torque limit in	0.0% ~ 200.0%	150.0%	☆
Function Code	Name	Set Range	default	Alteration
P2-11	Torque limit source in speed control (in regenerative state)	0: Function code P2-12 setting (no distinction between electric and power generation) 1: AI1 2: AI2 3: AI3 4: High-speed pulse input setting 5: communication given 6: MIN (AI1, AI2) 7: MAX (AI1, AI2) 8: Function code P2-12 setting 1-7 The full scale of the option corresponds to P2-12	0	☆
P2-12	Digital setting of torque limit in speed control (in regenerative state)	0.0% ~ 200.0%	150.0%	☆
P2-13	Excitation adjustment proportional gain	0 ~ 60000	2000	☆
P2-14	Excitation adjustment integral gain	0 ~ 60000	1300	☆
P2-15	Torque adjustment proportional gain	0 ~ 60000	2000	☆
P2-16	Torque adjustment integral gain	0 ~ 60000	1300	☆
P2-17	Speed loop integral separation selection	0: Disabled 1: Enabled	0	☆
P2-20	Max output voltage	-	-	-

P2-21	Max. torque coefficient of field weakening area	50~200%	100%	☆
P2-22	Regenerative power limit selection	0: Disabled 1: Enabled	0	☆
P2-23	Regenerative power limit	0~200%	Model dependent	☆
P3 V/F Control Parameters				
P3-00	V/F curve setting	0: Straight line V / F 1: multi-point V / F 2: square V / F 3: 1.2 Power V / F 4: 1.4 Power V / F 6: 1.6 Power V / F 8: 1.8 power V / F 9: Reserved 10: VF complete separation mode 11: VF semi-separation mode	0	★
P3-01	Torque boost	0.0% : (Ineffective)	Model dependent	☆
P3-02	Cut-off frequency of torque boost	0.00Hz ~ max frequency	50.00Hz	★
P3-03	Multi-point V/F frequency 1	0.00Hz ~ P3-05	0.00Hz	★
Function Code	Name	Set Range	default	Alteration
P3-04	Multi-point V/F voltage 1	0.0% ~ 100.0%	0.0%	★
P3-05	Multi-point V/F frequency 2	P3-03 ~ P3-07	0.00Hz	★
P3-06	Multi-point V/F voltage 2	0.0% ~ 100.0%	0.0%	★
P3-07	Multi-point V/F frequency 3	P3-05 ~ motor rated frequency (P1-04)	0.00Hz	★
P3-08	Multi-point V/F voltage 3	0.0% ~ 100.0%	0.0%	★
P3-09	Slip compensation gain	-	-	-
P3-10	V/F over-excitation gain	0 ~ 200	64	☆
P3-11	V/F oscillation suppression gain	0 ~ 100	40	☆

P3-13	Voltage source for V/F separation	0: digital setting (P3-14) 1: AI1 (Note: J6 jumper) 2: AI2 3: AI3 4: High-speed pulse input setting (S5) 5: multi-segment instructions 6: Simple PLC 7: PID 8: communication given Note: 100.0% corresponds to the motor rated voltage	0	☆
P3-14	Digital setting of voltage for V/F	0V ~ motor rated voltage	0V	☆
P3-15	Voltage rise time of V/F separation	0.0s ~ 1000.0s Note: 0v to rated motor voltage	0.0s	☆
P3-16	Voltage decline time of V/F separation	0.0s~1000.0s Note: time of 0v to rated motor voltage	0.0s	☆
P3-17	Stop mode selection for V/F separation	0: Frequency and voltage declining to 0 independently	0	☆
P3-18	Current limit level	50~200%	150%	★
P3-19	Current limit selection	0 : useless 1 : useful	1	★
P3-20	Current limit gain	0~100	20	☆
P3-21	Compensation factor of speed multiplying current limit level	50~200%	50%	★
P3-22	Voltage limit	650V~800.0V	770V	★
P3-23	Voltage limit selection	0 : useless 1 : useful	1	★
P3-24	Frequency gain for voltage limit	0~100	30	☆
P3-25	Voltage gain for voltage limit	0~100	30	☆

P3-26	Frequency rise threshold during	0~50Hz	5Hz	★
Function Code	Name	Set Range	default	Alteration
P4 Input Terminals				
P4-01	S2 function selection		4	★
P4-02	S3 function selection		9	★
P4-03	S4 function selection		12	★
P4-04	S5 function selection		13	★

Function Code	Name	Set Range	default	Alteration
P4-10	S1~S5 filter time	0.000s ~ 1.000s	0.010s	☆
P4-11	Terminal control mode	0: two lines 1 1: two lines 2 2: three lines 1 3: three lines 2	-	★
P4-12	Terminal UP/DOWN rate	0.001Hz/s ~ 65.535Hz/s	1.00Hz/s	☆
P4-13	AI curve 1 min. input	0.00V ~ P4-15	0.00V	☆
P4-14	Corresponding percentage of AI curve 1 min. input	-100.0% ~ +100.0%	0.0%	☆
P4-15	AI curve 1 max. input	P4-13 ~ +10.00V	10.00V	☆
P4-16	Corresponding percentage of AI curve 1 max. input	-100.0% ~ +100.0%	100.0%	☆
P4-17	AI1 filter time	0.00s ~ 10.00s	0.10s	☆
P4-18	AI curve 2 min. input	0.00V ~ P4-20	0.00V	☆
P4-19	Corresponding percentage of AI curve 2 min. input	-100.0% ~ +100.0%	0.0%	☆
P4-20	AI curve 2 max. input	P4-18 ~ +10.00V	10.00V	☆
P4-21	Corresponding percentage of AI Curve 2 max. input	-100.0% ~ +100.0%	100.0%	☆
P4-22	AI2 filter time	0.00s ~ 10.00s	0.10s	☆
P4-23	AI3 curve min. input	-10.00V ~ P4-25	0.00V	☆
P4-24	Corresponding percentage of AI curve 3 min. input	-100.0% ~ +100.0%	0.0%	☆
P4-25	AI curve 3 max. input	P4-23 ~ +10.00V	10.00V	☆
P4-26	Corresponding percentage of AI Curve 3 max. input	-100.0% ~ +100.0%	100.0%	☆

P4-27	AI3 filter time	0.00s ~ 10.00s	0.10s	☆
P4-28	Pulse min. input	0.00kHz ~ P4-30	0.00kHz	☆
P4-29	Corresponding percentage of pulse min. input	-100.0% ~ 100.0%	0.0%	☆
P4-30	Pulse max. input	P4-28 ~ 100.00kHz	50.00kHz	☆
P4-31	Corresponding percentage of Pulse max. input	-100.0% ~ 100.0%	100.0%	☆
P4-32	Pulse filter time	0.00s ~ 10.00s	0.10s	☆
Function Code	Name	Set Range	default	Alteration
P4-33	AI curve selection	Bit: AI1 curve selection 1: curve 1 (2 points, see P4-13 ~ P4-16) 2: Curve 2 (2 points, see P4-18 ~ P4-21) 3: curve 3 (2 points, see P4-23 ~ P4-26) 4: curve 4 (4 points, see A6-00 ~ A6-07) 5: curve 5 (4 points, see A6-08 ~ A6-15) Ten: AI2 curve selection, ibid Hundreds: AI3 curve selection, ibid	321	☆
P4-34	Setting selection when AI less than min. input	Bit: AI1 is lower than the minimum input setting 0: corresponds to the minimum input setting 1: 0.0% Ten: AI2 is lower than the minimum input setting, ibid Hundreds: AI3 is lower than the minimum input setting, ibid	000	☆
P4-35	S1 delay	0.0s ~ 3600.0s	0.0s	★
P4-36	S2 delay	0.0s ~ 3600.0s	0.0s	★
P4-37	S3 delay	0.0s ~ 3600.0s	0.0s	★

Function Code		Name	Set Range	default	Alteration
P4-38	S1~S5	active mode selection 1	Bit: \$1 Ten: \$20: No output Hundred: The inverter is running Thousand: fault output (fault stop) Million: Frequency level detection	00000	★
	P5-01	HDY function selection	3: FDT1 output 4: frequency arrives	0	☆
P5 Output Parameters					
P5-00	HDO	terminal output mode	0: pulse output (ADP shutdown) 1: Switching output (HDY pre-alarm) 7: Inverter overload pre-alarm	0	☆
P5-02		function selection (RO1A-RO1B-RO1C)	8: Set the count value to reach 9: Specifies that the count value arrives 10: length to reach 11: PLC cycle is complete 12: The cumulative run time arrives 13: Frequency limit 14: Torque limit 15: Ready to run 16: AI1> AI2 17: upper limit frequency arrival 18: Lower frequency arrival (operation related) 19: Under voltage status output 20: communication settings 21: Positioning completed (reserved)	2	☆
			22: positioning close (reserved) 23: zero speed running 2 (also output when stopped) 24: The total power-up time arrives 25: Frequency level detection FDT2 output 26: Frequency 1 reaches the output 27: Frequency 2 reaches the output	0	☆
			28: current 1 reaches the output 29: current 2 reaches the output 30: Timing arrival output 31: AI1 input is overrun 32: Under load	1	☆
			33: reverse running	-	☆

		34: zero current state 35: Module temperature arrives 36: Output current is exceeded 37: Lower frequency arrival (shutdown also output) 38: Alarm output (continued) 39: Motor over temperature warning 40: This run time arrives 41: fault output (for free stop fault), and under voltage is not output		
Function Code	Name	Set Range	default	Alteration
P5-06	HDP function selection	0: operating frequency 1: Set frequency 2: Output current 3: Output torque 4: Output power 5: Output voltage 6: High speed pulse input (100.% corresponds to 100.0 kHz) 7: AI1 (Note: J6 jumper) 8: AI2 9: AI3 10: length 11: count value 12: communication settings 13: motor speed 14: Output current: 100.0% vs. 1000.0A 15: Output voltage: 100.0% corresponds to 1000.0V 16: motor output torque (actual value, relative motor percentage)	0	☆
P5-07	AO1 function selection		0	☆
			1	☆
P5-09	HDO output frequency	0.01kHz ~ 100.00kHz	50.00kHz	☆
P5-10	AO1 zero offset coefficient	-100.0% ~ +100.0%	0.0%	☆
P5-11	AO1 gain	-10.00 ~ +10.00	1.00	☆
P5-17	HDY output delay	0.0s ~ 3600.0s	0.0s	☆
P5-18	Relay 1 output delay	0.0s ~ 3600.0s	0.0s	☆
P5-20	DO output delay	0.0s ~ 3600.0s	0.0s	☆

P5-22	active mode selection	0: Positive logic 1: anti logic Bit: HDO (HDY) Ten: RO1A Hundred places: RO2A Thousands of bits: DO Million: reserved	00000	☆
Function Code	Name	Set Range	default	Iteration
P6 Start/Stop Control				
P6-00	Start mode	0: Direct start 1: Catching a spinning motor 2: Pre-excited start 3: SVC quick start	0	☆
P6-01	Mode of catching a spinning motor	0: From stop frequency 1: From 50 Hz 2: From max. frequency	0	★
P6-02	Speed of catching a spinning motor	1 ~ 100	20	☆
P6-03	Start frequency	0.00Hz ~ 10.00Hz	0.00Hz	☆
P6-04	Start frequency holding time	0.0s ~ 100.0s	0.0s	★
P6-05	DC injection braking 1 level/Pre excitation level	0% ~ 100%	50%	★
P6-06	DC injection braking 1 active time /Pre-excitation active time	0.0s ~ 100.0s	0.0s	★
P6-07	Acceleration/Deceleration mode	0:Linear acceleration / deceleration 1:S-curve acceleration / deceleration A (static) 2:S curve acceleration / deceleration B (dynamic)	0	★
P6-08	Time proportion of S-curve start segment	0.0% ~ (100.0%-P6-09)	30.0%	★
P6-09	Time proportion of S-curve end segment	0.0% ~ (100.0%-P6-08)	30.0%	★

P6-10	Stop mode	0: Decelerate to stop 1: Coast to stop	0	☆
P6-11	DC injection braking 2 start frequency	0.00Hz ~ max frequency(P0-10)	0.00Hz	☆
P6-12	DC injection braking 2 delay time	0.0s ~ 100.0s	0.0s	☆
P6-13	DC injection braking 2 level	0% ~ 100%	50%	☆
P6-14	DC injection braking 2 active time	0.0s ~ 100.0s	0.0s	☆
P6-15	Braking use ratio	0% ~ 100%	100%	☆
P6-18	Catching a spinning motor current limit	30%~200%	Model dependent	☆
P6-21	Demagnetization time (effective for SVC)	0.00~5.00s	Model dependent	☆
P7 Keypad Operation and LED Display				
P7-01	JOG default display check	0: JOG is invalid 1: Operation panel command channel and remote command channel (terminal command channel or communication command channel) switch 2: Forward and reverse switching 3: moving forward 4: reverse jog	0	★
Function Code	Name	Set Range	default	Alteration
P7-02	STOP/RESET key function	0: The STOP / RES key stop function is valid only during keyboard operation 1: STOP / RES key shutdown is active in any mode of operation	1	☆

P7-03	LED display running parameters 1	0000 ~ FFFF Bit00: Operating frequency 1 (Hz) Bit01: Set frequency (Hz) Bit02: Bus voltage (V) Bit03: Output voltage (V) Bit04: Output current (A) Bit05: Output power (kW) Bit06: Output torque (%) Bit07: S terminal input status Bit08: HDO output status Bit09: AI1 voltage (V) Bit10: AI2 Voltage (V) Bit11: AI3 Voltage (V) Bit12: Count value Bit13: Length value Bit14: Load speed display Bit15: PID setting	1F	☆
P7-04	LED display running parameters 2	0000 ~ FFFF Bit00: PID feedback Bit01: PLC stage Bit02: High-speed pulse input frequency (kHz) Bit03: Operating frequency 2 (Hz) Bit04: Remaining runtime Bit05: AI1 before correction voltage (V) Bit06: AI2 before correction voltage (V) Bit07: AI3 Correction before voltage (V) Bit08: Line speed Bit09: Current power-on time (Hour) Bit10: Current running time (Min) Bit11: High-speed pulse input frequency (Hz) Bit12: Communication setpoint Bit13: Encoder feedback speed (Hz) Bit14: Main frequency A display (Hz) Bit15: Secondary frequency B display (Hz)	0	☆

P7-05	LED display stop parameters	0000 ~ FFFF Bit00: Set frequency (Hz) Bit01: Bus voltage (V) Bit02: S input status Bit03: HDO output status Bit04: AI1 voltage (V) Bit05: AI2 voltage (V) Bit06: AI3 voltage (V) Bit07: Count value Bit08: Length value Bit09: PLC stage Bit10: Load speed Bit11: PID setting Bit12: High-speed pulse input frequency (kHz)	33	☆
Function Code	Name	Set Range	default	Alteration
P7-06	Load speed display coefficient	0.0001 ~ 6.5000	1.0000	☆
P7-07	Heatsink temperature of AC Drive IGBT	-20.0°C ~ 120.0°C	-	●
P7-09	Accumulative running time	0h ~ 65535h	-	●
P7-12	Number of decimal places for load speed display	Bit: d0-14 the number of decimal places 0: 0 decimal places 1: 1 decimal place 2: 2 decimal places 3: 3 decimal places Ten: d0-19 / d0-29 the number of decimal places 1: 1 decimal place 2: 2 decimal places	21	☆
P7-13	Accumulative power-on time	0h ~ 65535h	-	●
P7-14	Accumulative power consumption	0kW ~ 65535kwh	-	●
Group P8: Auxiliary Functions				
P8-00	Jog frequency reference	0.00 Hz to max. frequency	2.00 Hz	☆
P8-01	Jog acceleration time	0.0s to 6500.0s	20.0s	☆
P8-02	Jog deceleration time	0.0s to 6500.0s	20.0s	☆
P8-03	Acceleration time 2	0.0s to 6500.0s	Model dependent	☆
P8-04	Deceleration time 2	0.0s to 6500.0s	Model dependent	☆

P8-05	Acceleration time 3	0.0s to 6500.0s	Model dependent	☆
P8-06	Deceleration time 3	0.0s to 6500.0s	Model dependent	☆
P8-07	Acceleration time 4	0.0s to 6500.0s	0.0s	☆
P8-08	Deceleration time 4	0.0s to 6500.0s	0.0s	☆
P8-09	Frequency jump 1	0.00 Hz to max. frequency	0.00 Hz	☆
P8-10	Frequency jump 2	0.00 Hz to max. frequency	0.00 Hz	☆
P8-11	Frequency jump band	0.00 Hz to max. frequency	0.00 Hz	☆
P8-12	Forward/Reverse run switch over dead-zone time	0.0s to 3000.0s	0.0s	☆
P8-13	Reverse RUN selection	0, 1	0	☆
P8-14	Running mode when frequency reference lower than frequency lower limit	0 to 2	0	☆
P8-15	Droop rate	0.00% to 100.00%	0.00%	☆
P8-16	Accumulative power-on time threshold	0 to 65000 h	0 h	☆
P8-17	Accumulative running time threshold	0 to 65000 h	0 h	☆
P8-18	Startup protection selection	0, 1	0	☆
P8-19	Frequency detection value 1	0.00 Hz to max. frequency	50.00 Hz	☆
P8-20	Frequency detection hysteresis 1	0.0% to 100.0%	5.0%	☆
P8-21	Detection width of target frequency reached	0.0% to 100.0%	0.0%	☆
P8-22	Jump frequency function	0, 1	0	☆
P8-25	Switchover frequency of accel time 1 and accel time 2	0.00 Hz to max. frequency	0.00 Hz	☆
P8-26	Switchover frequency of decel time 1 and decel time 2	0.00 Hz to max. frequency	0.00 Hz	☆
P8-27	Set highest priority to terminal JOG function	0, 1	0	☆
P8-28	Frequency detection value (FDR2)	0.00 Hz to max. frequency	50.00 Hz	☆
P8-29	Frequency detection hysteresis (FDT2)	0.0% to 100.0%	5.0%	☆
P8-30	Detection of frequency 1	0.00 Hz to max. frequency	50.00 Hz	☆

P8-31	Detection width of frequency 1	0.0% to 100.0% (max. frequency)	0.0%	☆
P8-32	Detection of frequency 2	0.00 Hz to max. frequency	50.00 Hz	☆
P8-33	Detection width of frequency 2	0.0% to 100.0% (max. frequency)	0.0%	☆
P8-34	Zero current detection level	0.0% to 300.0% (rated motor current)	5.0%	☆
P8-35	Zero current detection delay	0.01s to 600.00s	0.10s	☆
P8-36	Output over current threshold	0.0% (no detection) 0.1% to 300.0% (rated motor current)	200.0%	☆
P8-37	Output over current detection delay	0.00s to 600.00s	0.00s	☆
P8-38	Detection level of current 1	0.0% to 300.0% (rated motor current)	100.0%	☆
P8-39	Detection width of current 1	0.0% to 300.0% (rated motor current)	0.0%	☆
P8-40	Detection level of current 2	0.0% to 300.0% (rated motor current)	100.0%	☆
P8-41	Detection width of current 2	0.0% to 300.0% (rated motor current)	0.0%	☆
P8-42	Timing function	0, 1	0	★
P8-43	Running time setting channel	0 to 3	0	★
P8-44	Running time	0.0 to 6500.0 min	0.0 min	★
P8-45	AI1 input voltage lower limit	0.00 V to F8-46	3.10 V	☆
P8-46	AI1 input voltage upper limit	F8-45 to 10.00 V	6.80 V	☆
P8-47	IGBT temperature threshold	0°C to 100°C	75°C	☆
P8-48	Cooling fan working mode	0, 1	0	☆
P8-49	Wakeup frequency	F8-51 to max. frequency (F0-10)	0.00 Hz	☆
P8-50	Wakeup delay time	0.0s to 6500.0s	0.0s	☆
P8-51	Hibernating frequency	0.00 Hz to wakeup frequency (F8-49)	0.00 Hz	☆
P8-52	Hibernating delay time	0.0s to 6500.0s	0.0s	☆
P8-53	Running time threshold this time	0.0 to 6500.0 min	0.0 min	☆
P8-54	Output power correction coefficient	0.0% to 200.0%	100.0%	☆
Group P9: Fault and Protection				

Function Code	Name	Set Range	FACTORY code	Alteration
P9-00	Motor overload protection	0, 1	1	☆
P9-01	Motor overload protection gain	0.20 to 10.00	1.00	☆
P9-02	Motor overload pre-warning coefficient	50% to 100%	80%	☆
P9-03	Over voltage protection gain	0 (no over voltage stall) to 100	30	☆
P9-04	Over voltage protection voltage	650 to 800 V	770 V	☆
P9-07	Detection of short-circuit to ground upon power-on		00 to 11	☆
P9-08	Braking unit applied voltage		650 to 800 V	760 V
P9-09	Auto reset times	0 to 20	0	☆
P9-10	Selection of DO action during auto reset	0, 1	0	☆
P9-11	Delay of auto reset	0.1s to 100.0s	1.0s	☆
P9-12	Input phase loss/pre-charge relay protection	00 to 11	-	☆
P9-13	Output phase loss protection	00 to 11	01	☆
P9-14	1st fault type	0 to 55	-	●
P9-15	2nd fault type	0 to 55	-	●
P9-16	3rd (latest) fault type	0 to 55	-	●

P9-17	Frequency upon 3rd fault	-	-	●
P9-18	Current upon 3rd fault	-	-	●
P9-19	Bus voltage upon 3rd fault	-	-	●
P9-20	DI state upon 3rd fault	-	-	●
P9-21	DO state upon 3rd fault	-	-	●
P9-22	AC drive state upon 3rd fault	-	-	●
P9-23	Power-on time upon 3rd fault	-	-	●
P9-24	Running time upon 3rd fault	-	-	●
P9-27	Frequency upon 2nd fault	-	-	●
P9-28	Current upon 2nd fault	-	-	●
P9-29	Bus voltage upon 2nd fault	-	-	●
P9-00	Motor overload protection	0, 1	1	☆
P9-30	DI state upon 2nd fault	-	-	●
P9-31	DO state upon 2nd fault	-	-	●
P9-32	AC drive state upon 2nd fault	-	-	●
P9-33	Power-on time upon 2nd fault	-	-	●
P9-34	Running time upon 2nd fault	-	-	●
P9-37	Frequency upon 1st fault	-	-	●
P9-38	Current upon 1st fault	-	-	●
P9-39	Bus voltage upon 1st fault	-	-	●
P9-40	DI state upon 1st fault	-	-	●
P9-41	DO state upon 1st fault	-	-	●
P9-42	AC drive state upon 1st fault	-	-	●
P9-43	Power-on time upon 1st fault	-	-	●
P9-44	Running time upon 1st fault	-	-	●
P9-47	Fault protection action selection 1	00000 to 22222	00000	☆
P9-48	Fault protection action selection 2	00000 to 11111	00000	☆
P9-50	Fault protection action selection 4	00000 to 22222	00000	☆

Group PA: PID Function

P9-54	Frequency selection for continuing to run upon fault	0 to 4	0	☆
P9-55	Backup frequency upon fault	0.0% to 100.0% (max. frequency)	100.0%	☆
P9-59	Power dip ride-through function selection	0 to 2	0	★
P9-60	Threshold of power dip ride through function disabled	80% to 100%	85%	★
P9-61	Judging time of bus voltage recovering from power dip	0.0s to 100.0s	0.5s	★
P9-62	Threshold of power dip ride through function enabled	60% to 100%	80%	★
P9-63	Load lost protection	0: Disabled 1: Enabled	0	☆
P9-64	Load lost detection level	0.0% to 100.0%	10.0%	☆
P9-65	Load lost detection time	0.0s to 60.0s	1.0s	☆
P9-67	Overspeed detection level	0.0% to 50.0% (max. frequency)	20.0%	☆
P9-68	Overspeed detection time	0.0s to 60.0s	1.0s	☆
P9-69	Detection level of speed error	0.0% to 50.0% (max. frequency)	20.0%	☆
P9-70	Detection time of speed error	0.0s to 60.0s	5.0s	☆
P9-71	Power dip ride-through gain Kp	0 to 100	40	☆
P9-72	Power dip ride-through integral coefficient	0 to 100	30	☆
P9-73	Deceleration time of power dip ride-through	0.0s to 300.0s	20.0s	★

Group PA: PID Function

Function Code	Name	Set Range	default	change
PA-00	PID reference setting channel	0 to 6	0	☆
PA-01	PID digital setting	0.0% to 100.0%	50.0%	☆
PA-03	PID operation direction	0, 1	0	☆
PA-04	PID reference and Feedback range	0 to 65535	1000	☆
PA-05	Proportional gain Kp1	0.0 to 1000.0	20.0	☆
PA-06	Integral time Ti1	0.01s to 10.00s	2.00s	☆
PA-07	Differential time Td1	0.000s to 10.000s	0.000s	☆
PA-08	PID output limit in reverse direction	0.00 Hz to max. frequency	0.00 Hz	★
PA-09	PID error limit	0.0% to 100.0%	0.0%	☆

PA-10	PID differential limit	0.00% to 100.00%	0.10%	☆
PA-11	PID reference change time	0.00s to 650.00s	0.00s	☆
PA-12	PID feedback filter time	0.00s to 60.00s	0.00s	☆
PA-13	PID output filter time	0.00s to 60.00s	0.00s	☆
PA-14	Reserved	-	-	-
PA-15	Proportional gain Kp2	0.0 to 1000.0	20.0	☆
PA-16	Integral time Ti2	0.01s to 10.00s	2.00s	☆
PA-17	Differential time Td2	0.000s to 10.000s	0.000s	☆
PA-18	PID parameter switchover condition	0 to 3	0	☆
PA-19	PID error 1 for auto switchover	0.0% to PA-20	20.0%	☆
PA-20	PID error 2 for auto switchover	PA-19 to 100.0%	80.0%	☆
PA-21	PID initial value	0.0% to 100.0%	0.0%	☆
PA-22	PID initial value active time	0.00s to 650.00s	0.00s	☆
PA-25	PID integral property	00 to 11	00	☆
PA-26	Detection level of PID feedback loss	0.0%: No detection 0.1% to 100.0%	0.0%	☆
PA-27	Detection time of PID feedback loss	0.0s to 20.0s	0.0s	☆
PA-28	Selection of PID operation at stop	0, 1	0	☆
Para. No.	Name	Setting Range	Default	Property
Group PB: Wobble Function, Fixed Length and Count				
PB-00	Wobble setting mode	0, 1	0	☆
PB-01	Wobble amplitude	0.0% to 100.0%	0.0%	☆
PB-02	Wobble step	0.0% to 50.0%	0.0%	☆
PB-03	Wobble cycle	0.0s to 3000.0s	10.0s	☆
PB-04	Triangular wave rising time coefficient	0.0% to 100.0%	50.0%	☆
PB-05	Set length	0 to 65535 m	1000 m	☆
PB-06	Actual length	0 to 65535 m	0 m	☆
PB-07	Number of pulses per meter	0.1 to 6553.5	100.0	☆
PB-08	Set count value	1 to 65535	1000	☆
PB-09	Designated count value	1 to 65535	1000	☆
Group PC: Multi - Reference and Simple PLC Function				
PC-00	Reference 0	-100.0% to 100.0%	0.0%	☆
PC-01	Reference 1	-100.0% to 100.0%	0.0%	☆
PC-02	Reference 2	-100.0% to 100.0%	0.0%	☆
PC-03	Reference 3	-100.0% to 100.0%	0.0%	☆
PC-04	Reference 4	-100.0% to 100.0%	0.0%	☆
PC-05	Reference 5	-100.0% to 100.0%	0.0%	☆
PC-06	Reference 6	-100.0% to 100.0%	0.0%	☆
PC-07	Reference 7	-100.0% to 100.0%	0.0%	☆

PC-08	Reference 8	-100.0% to 100.0%	0.0%	☆
PC-09	Reference 9	-100.0% to 100.0%	0.0%	☆
PC-10	Reference 10	-100.0% to 100.0%	0.0%	☆
PC-11	Reference 11	-100.0% to 100.0%	0.0%	☆
PC-12	Reference 12	-100.0% to 100.0%	0.0%	☆
PC-13	Reference 13	-100.0% to 100.0%	0.0%	☆
PC-14	Reference 14	-100.0% to 100.0%	0.0%	☆
PC-15	Reference 15	-100.0% to 100.0%	0.0%	☆
PC-16	Simple PLC running mode	0 to 2	0	☆
PC-17	Simple PLC retentive selection	00 to 11	00	☆
PC-18	Running time of simple PLC reference 0	0.0s (h) to 6553.5s (h)	0.0s (h)	☆
PC-19	Acceleration/deceleration time of simple PLC reference 0	0 to 3	0	☆
PC-20	Running time of simple PLC reference 1	0.0s (h) to 6553.5s (h)	0.0s (h)	☆
PC-21	Acceleration/deceleration time of simple PLC reference 1	0 to 3	0	☆
PC-22	Running time of simple PLC reference 2	0.0s (h) to 6553.5s (h)	0.0s (h)	☆

Para. No.	Para. Name	Setting Range	Default	Property
PC-23	Acceleration/deceleration time of simple PLC reference 2	0 to 3	0	☆
PC-24	Running time of simple PLC reference 3	0.0s (h) to 6553.5s (h)	0.0s (h)	☆
PC-25	Acceleration/deceleration time of simple PLC reference 3	0 to 3	0	☆
PC-26	Running time of simple PLC reference 4	0.0s (h) to 6553.5s (h)	0.0s (h)	☆
PC-27	Acceleration/deceleration time of simple PLC reference 4	0 to 3	0	☆
PC-28	Running time of simple PLC reference 5	0.0s (h) to 6553.5s (h)	0.0s (h)	☆
PC-29	Acceleration/deceleration time of simple PLC reference 5	0 to 3	0	☆
PC-30	Running time of simple PLC reference 6	0.0s (h) to 6553.5s (h)	0.0s (h)	☆
PC-31	Acceleration/deceleration time of simple PLC reference 6	0 to 3	0	☆
PC-32	Running time of simple PLC reference 7	0.0s (h) to 6553.5s (h)	0.0s (h)	☆
PC-33	Acceleration/deceleration time of simple PLC reference 7	0 to 3	0	☆
PC-34	Running time of simple PLC reference 8	0.0s (h) to 6553.5s (h)	0.0s (h)	☆
PC-35	Acceleration/deceleration time of simple PLC reference 8	0 to 3	0	☆
PC-36	Running time of simple PLC reference 9	0.0s (h) to 6553.5s (h)	0.0s (h)	☆
PC-37	Acceleration/deceleration time of simple PLC reference 9	0 to 3	0	☆

PC-38	Running time of simple PLC reference 10	0.0s (h) to 6553.5s (h)	0.0s (h)	☆
PC-39	Acceleration/deceleration time of simple PLC reference 10	0 to 3	0	☆
PC-40	Running time of simple PLC reference 11	0.0s (h) to 6553.5s (h)	0.0s (h)	☆
PC-41	Acceleration/deceleration time of simple PLC reference 11	0 to 3	0	☆
PC-42	Running time of simple PLC reference 12	0.0s (h) to 6553.5s (h)	0.0s (h)	☆
PC-43	Acceleration/deceleration time of simple PLC reference 12	0 to 3	0	☆
PC-44	Running time of simple PLC reference 13	0.0s (h) to 6553.5s (h)	0.0s (h)	☆
PC-45	Acceleration/deceleration time of simple PLC reference 13	0 to 3	0	☆
PC-46	Running time of simple PLC reference 14	0.0s (h) to 6553.5s (h)	0.0s (h)	☆
PC-47	Acceleration/deceleration time of simple PLC reference 14	0 to 3	0	☆
PC-48	Running time of simple PLC reference 15	0.0s (h) to 6553.5s (h)	0.0s (h)	☆

Para. No.	Para. Name	Setting Range	Default	Property
-----------	------------	---------------	---------	----------

A2-07	Rotor resistance	0.001 to 65.535 Ω (AC drive power \leq 55 kW) 0.0001 to 6.5535 Ω (AC drive power $>$ 55 kW)	Auto-tuning dependent	★
A2-08	Leakage inductive reactance	0.01 to 655.35 mH (AC drive power \leq 55 kW) 0.001 to 65.535 mH (AC drive power $>$ 55 kW)	Auto-tuning dependent	★
A2-09	Mutual inductive reactance	0.1 to 6553.5 mH (AC drive power \leq 55 kW) 0.01 to 655.35 mH (AC drive power $>$ 55 kW)	Auto-tuning dependent	★
A2-10	No-load current	0.01 A to A2-03 (AC drive power \leq 55 kW) 0.1 A to A2-03 (AC drive power $>$ 55 kW)	Auto-tuning dependent	★
A2-27	Encoder pulses per revolution	1 to 65535	1024	★
A2-28	Encoder type	0: ABZ incremental encoder 2: Resolver	0	★
A2-29	Speed feedback channel selection	0: Local PG card 1: Extension PG card 2: Pulse input (s5)	0	★
A2-30	A/B phase sequence of ABZ incremental encoder	0: Forward 1: Reserve	0	★
A2-31	Encoder installation angle	0.0 to 359.9	0.0	★
A2-34	Number of pole pairs of resolver	1 to 65535	1	★
A2-36	Encoder wire-break fault detection time	0.0s: No detection 0.1s to 10.0s	0.0s	★
A2-37	Auto-tuning selection	0 to 3	0	★
A2-38	Speed loop proportional gain 1	1 to 100	30	☆
A2-39	Speed loop integral time 1	0.01s to 10.00s	0.50	☆
A2-40	Switch over frequency 1	0.00 to A2-43	5.00	☆
A2-41	Speed loop proportional gain 2	1 to 100	20	☆
A2-42	Speed loop integral time 2	0.01s to 10.00s	1.00	☆
A2-43	Switch over frequency 2	A2-40 to max. frequency	10.00	☆
A2-44	Vector control slip gain	50% to 200%	100%	☆
A2-45	Speed loop filter time constant	0.000s to 0.100s	0.000s	☆
A2-47	Torque limit source in speed control	0: A2-48 setting 1: AI1 (Note: J6 jumper) 2: AI2 3: AI3 4: High-speed pulse input (S5) 5: communication given 6: MIN (AI1, AI2) 7: MAX (AI1, AI2)	0	☆

		1-7 option full scale, corresponding to A2-48 digital settings		
A2-48	Digital setting of torque limit in speed control	0.0% to 200.0%	150.0%	☆
A2-49	Torque limit source in speed control (regenerative)	0: Function code P2-10 setting 1: AI1 (Note: J6 jumper) 2: AI2 3: AI3 4: High-speed pulse input setting (S5) 5: communication given 6: MIN (AI1, AI2) 7: MAX (AI1, AI2) 8: Function code P2-12 setting 1-7 option full scale, corresponding to P2-12 digital settings	0	☆

Para. No.	Para. Name	Setting Range	Default	Property
A2-50	Digital setting of torque limit in speed control (regenerative)	0.0% to 200.0%	150.0%	☆
A2-51	Excitation adjustment proportional gain	0 to 60000	2000	☆
A2-52	Excitation adjustment integral gain	0 to 60000	1300	☆
A2-53	Torque adjustment proportional gain	0 to 60000	2000	☆
A2-54	Torque adjustment integral gain	0 to 60000	1300	☆
A2-55	Speed loop integral separation selection	0: Disabled 1: Enabled	0	☆
A2-59	Max. torque coefficient in field	50% to 200%	100%	☆

	weakening area			
A2-60	Regenerative power limit selection	0: Disabled 1: Enabled in whole process 2: Enabled at constant speed 3: Enabled during deceleration	0	☆
A2-61	Regenerative power upper limit	0.0% to 200.0%	Model dependent	☆
A2-62	Motor 2 control mode	0 to 2	0	★
A2-63	Motor 2 acceleration/deceleration time selection	0 to 4	0	☆
A2-64	Motor 2 torque boost	0.0%: Ineffective 0.1% to 30.0%	Model dependent	☆
A2-66	Motor 2 oscillation suppression gain	0 to 100	40	☆
Group A5: Control Optimization				
A5-00	DPWM switchover frequency upper limit	5.00 Hz to max. frequency	8.00 Hz	☆
A5-01	PWM modulation pattern	0, 1	0	☆
A5-02	Dead zone compensation mode selection	0, 1	1	☆
A5-03	Random PWM depth	0 to 10	0	☆
A5-04	Over current fast prevention	0, 1	1	☆
A5-05	Voltage over modulation coefficient	100% to 110%	105%	★
A5-06	Under voltage threshold	210 to 420 V	350 V	☆
A5-08	Dead-zone time adjustment	100% to 200%	150%	★
A5-09	Over voltage threshold	200.0 to 2500.0 V	Model dependent	★
Para. No.	Para. Name	Setting Range	Default	Property
Group A6: AI Curve Setting				
A6-00	AI curve 4 min. input	-10.00 V to A6-02	0.00 V	☆
A6-01	Corresponding percentage of AI curve 4 min. input	-100.0% to 100.0%	0.0%	☆
A6-02	AI curve 4 inflexion 1 input	A6-00 to A6-04	3.00 V	☆
A6-03	Corresponding percentage of AI curve 4 inflexion 1 input	-100.0% to 100.0%	30.0%	☆
A6-04	AI curve 4 inflexion 2 input	A6-02 to A6-06	6.00 V	☆
A6-05	Corresponding percentage of AI curve 4 inflexion 2 input	-100.0% to 100.0%	60.0%	☆
A6-06	AI curve 4 max. input	A6-04 to 10.00 V	10.00 V	☆
A6-07	Corresponding percentage of AI curve 4 max. input	-100.0% to 100.0%	100.0%	☆
A6-08	AI curve 5 min. input	-10.00 V to A6-10	-10.00 V	☆
A6-09	Corresponding percentage of AI curve 5 min. input	-100.0% to 100.0%	-100.0%	☆

A6-10	AI curve 5 inflexion 1 input	A6-08 to A6-12	-3.00 V	☆
A6-11	Corresponding percentage of AI curve 5 inflexion 1 input	-100.0% to 100.0%	-30.0%	☆
A6-12	AI curve 5 inflexion 2 input	A6-10 to A6-14	3.00 V	☆
A6-13	Corresponding percentage of AI curve 5 inflexion 2 input	-100.0% to 100.0%	30.0%	☆
A6-14	AI curve 5 max. input	A6-12 to 10.00 V	10.00 V	☆
A6-15	Corresponding percentage of AI curve 5 max. input	-100.0% to 100.0%	100.0%	☆
A6-24	Jump point of AI1 input corresponding setting	-100.0% to 100.0%	0.0%	☆
A6-25	Jump amplitude of AI1 input corresponding setting	0.0% to 100.0%	0.5%	☆
A6-26	Jump point of AI2 input corresponding setting	-100.0% to 100.0%	0.0%	☆
A6-27	Jump amplitude of AI2 input corresponding setting	0.0% to 100.0%	0.5%	☆
A6-28	Jump point of AI3 input corresponding setting	-100.0% to 100.0%	0.0%	☆
Group AC: AI/AO Correction				
AC-00	AI1 measured voltage 1	-10.00 to 10.000 V	factory corrected	☆
AC-01	AI1 displayed voltage 1	-10.00 to 10.000 V	factory corrected	☆
AC-02	AI1 measured voltage 2	-10.00 to 10.000 V	factory corrected	☆
AC-03	AI1 displayed voltage 2	-10.00 to 10.000 V	factory corrected	☆
AC-04	AI2 measured voltage 1	-10.00 to 10.000 V	factory corrected	☆
AC-05	AI2 displayed voltage 1	-10.00 to 10.000 V	factory corrected	☆
AC-06	AI2 measured voltage 2	-10.00 to 10.000 V	factory corrected	☆
AC-07	AI2 displayed voltage 2	-10.00 to 10.000 V	factory corrected	☆
AC-08	AI3 measured voltage 1	-10.00 to 10.000 V	factory corrected	☆
AC-09	AI3 displayed voltage 1	-10.00 to 10.000 V	factory corrected	☆

AC-10	AI3 measured voltage 2	-10.00 to 10.000 V	factory corrected	☆
AC-11	AI3 displayed voltage 2	-10.00 to 10.000 V	factory corrected	☆
AC-12	AO1 target voltage 1	-10.00 to 10.000 V	factory corrected	☆
AC-13	AO1 measured voltage 1	-10.00 to 10.000 V	factory corrected	☆
AC-14	AO1 target voltage 2	-10.00 to 10.000 V	factory corrected	☆
AC-15	AO1 measured voltage 2	-10.00 to 10.000 V	factory corrected	☆
AC-16	AO2 target voltage 1	-10.00 to 10.000 V	factory corrected	☆
AC-17	AO2 measured voltage 1	-10.00 to 10.000 V	factory corrected	☆
AC-18	AO2 target voltage 2	-10.00 to 10.000 V	factory corrected	☆
AC-19	AO2 measured voltage 2	-10.00 to 10.000 V	factory corrected	☆

5.2 monitoring parameters

Para. No.	Para. Name	Display Range	Communication add
Group dO: Monitoring Parameters			
dO-00	Running frequency	0.01Hz	7000H
dO-01	Frequency reference	0.01Hz	7001H
dO-02	Bus voltage	0.1V	7002H
dO-03	Output voltage	1V	7003H
dO-04	Output current	0.01A	7004H
dO-05	Output power	0.1kW	7005H
dO-06	Output torque	0.1%	7006H
dO-07	S state INPUT stature	1	7007H
dO-08	HDO output state	1	7008H
dO-09	AI1 voltage	0.01V	7009H
dO-10	AI2 voltage/current	0.01V/0.01mA	700AH
dO-11	AI3 voltage	0.01V	700BH
dO-12	Count value	1	700CH
dO-13	length value	1	700DH
dO-14	Load speed display	1	700EH
dO-15	PID reference	1	700FH
dO-16	PID feedback	1	7010H
dO-17	PLC stage	1	7011H
dO-18	Pulse reference	0.01kHz	7012H
dO-19	feedback speed	0.01Hz	7013H
dO-20	Remaining running time	0.1Min	7014H
dO-21	AI1 voltage before correction	0.001V	7015H
dO-22	AI2 voltage (V)/ current (MA) before correction	0.001V/0.01mA	7016H
dO-23	AI3 voltage before correction	0.001V	7017H
dO-24	Motor speed	1m/Min	7018H
dO-25	Accumulative power-on time	1Min	7019H
dO-26	Accumulative running time	0.1Min	701AH
dO-27	Pulse reference	1Hz	701BH
dO-28	Communication reference	0.01%	701BH
dO-29	Encoder feedback speed	0.01%	701CH
dO-30	Main frequency A reference	0.01Hz	701DH
dO-31	Auxiliary frequency B reference	0.01Hz	701EH

dO-32	Viewing any register address value	0.01Hz	701FH
dO-34	Motor temperature	1	7020H
dO-35	Target torque	1°C	7022H
dO-36	Resolver position	0.1%	7023H

6. Parameter Description

Function code	Description	Application
P0-01 : 1st motor speed control mode	Set 0 : non-speed Sensor vector control (SVC)	Refers to open loop vector control, suitable for the usual high-performance control occasions, a drive can only drive a motor. Such as machine tools, centrifuges, drawing machines, injection molding machines and other loads.
	Set 1 : with speed Sensor vector control (FVC)	Refers to the closed-loop vector control, the motor must be installed encoder, the inverter must be the same type of adapter with the PG card. Suitable for high-precision speed control or torque control of the occasion. A drive can only drive one motor. Such as high-speed paper making machinery, lifting machinery, elevators and other loads.
	Set 2 : V/F control (speed degree open loop control) (Factory default)	Applicable to the load requirements are not high, or a drive drag multiple motor occasions, such as fans, pump load. Can be used for a drive drag more than one motor occasions.

P0-03	Main frequency source A selection	Factory default	2
	Set range	0: digital setting (preset frequency P0-08, UP / DOWN can be modified, power is not memory) 1: digital setting (preset frequency P0-08, UP / DOWN can be modified, power-down memory) 2: AI1 (J6 jumper) 3: AI2 4: AI3 5: High-speed pulse setting (S5) 6: Multi-step command 7: PLC 8: PID 9: Communication	

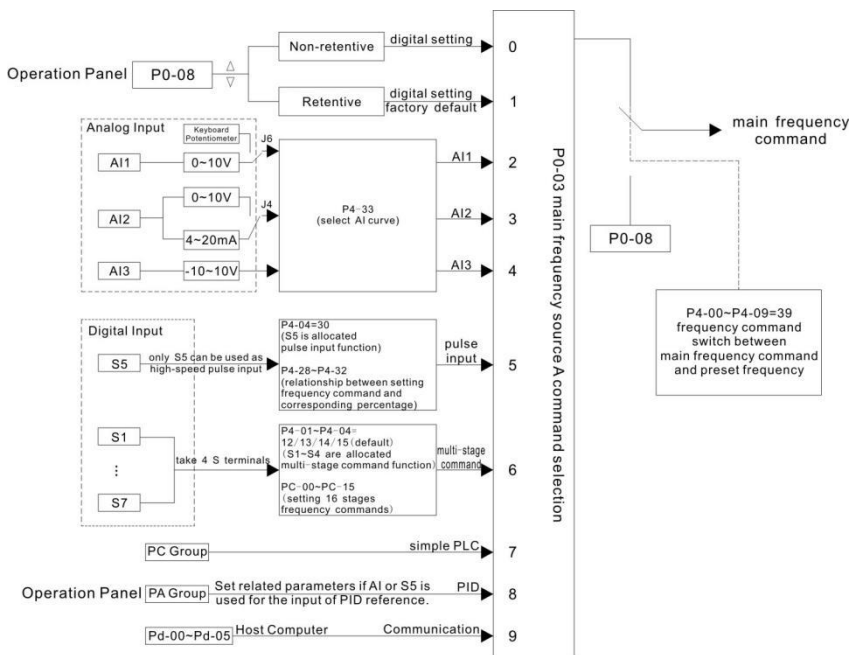

Pic 6-1

Select the input channel for the given frequency of the drive. AI1, AI2, AI3, high-speed pulse setting (S5), multi-segment instructions, PLC, PID, and so on.

Notes: P0-23 is "digital setting frequency stop memory selection", P0-23 is used to select whether the correction amount of frequency is memorized or cleared when the inverter is stopped. P0-23 no relate to shut down, not related to power-down memory, the application should pay attention.

8 : PID

Select the output of the process PID control as the operating frequency. Generally used in the field of closed-loop control technology, such as constant pressure closed-loop control, constant tension closed-loop control and other occasions.

When PID is used as the frequency source, it is necessary to set the parameters related to PID function of PA group.

9 : Communication given

The frequency is given by communication.

When a point-to-point communication slave is used and the received data is given as a frequency, the host uses the data transfer as the communication set point (see A8 group description)

Otherwise the host computer communication address 0×1000 given data, the data format is

-100.00% to 100.00%, 100.00% refers to the relative maximum frequency P0-10 percentage. DSI-200 support two kinds of host computer communication: Modbus, CANlink, these two kinds of communication cannot be used at the same time.

The CANlink protocol is always valid

P0-04	Auxiliary frequency source B command selection	Factory default	0
	Set range	0: digital setting (preset frequency P0-08, UP / DOWN can be modified, power is not memory) 1: digital setting (preset frequency P0-08, UP / DOWN can be modified, power-down memory) 2: AI1 (J6 jumper) 3: AI2 4: AI3 5: High-speed pulse setting (S5) 6: Multi-step command 7: PLC 8: PID 9: Communication reference	

The auxiliary frequency source is the same as the main frequency source A when it is used as a separate frequency reference channel (i.e., the frequency source is selected as A to B switch). Refer to the description of P0-03.

When the auxiliary frequency source is used as a cascade reference (i.e., the composite frequency reference for the main frequency source A and the auxiliary frequency source B), it is important to note:

- 1) When the auxiliary frequency source is digital, the preset frequency (P0-08) does not work, the user through the keyboard ▲, ▼ key (or multi-function input terminal UP, DOWN) frequency adjustment, directly in the main given the frequency on the basis of adjustment.
- 2) When the auxiliary frequency source is set for analog input (AI1, AI2, and AI3) or pulse input, enter 100% of the setting, corresponding to the auxiliary frequency source range, which can be set by P0-05 and P0-06.
- 3) The frequency source is a pulse input reference, similar to the analog reference.

Tip: Auxiliary frequency source B selection with the main frequency source a selection, cannot be set to the same channel, that is, P0-03 and P0-04 do not set the same value, otherwise easily lead to confusion.

P0-05	Auxiliary frequency source B selection	Factory default	0
	Set range	0 : Relative to the maximum frequency 1 : Relative to the main frequency source A	
P0-06	Auxiliary frequency source B command range	Factory default	100%
	Set range	0% ~ 150%	

These parameters are used to determine the adjustment range of the auxiliary frequency source when the frequency source is selected as "frequency combination" (i.e., P0-07 = 1, 3 or 4).

P0-05 is used to determine the object corresponding to the auxiliary frequency source range, which can be selected relative to the maximum frequency or relative to the main frequency

source A. If the range is selected relative to the main frequency source, the range of the auxiliary frequency source Frequency A changes

P0-07	Frequency source combination mode selection	Factory default	0	
	Set range	Bit	Frequency source selection	
		0: Main frequency source A 1: Main and auxiliary operation result (calculation relationship is determined by ten bits) 2: Main frequency source A and auxiliary frequency source B switching 3: Main frequency source A and master and slave operation result switching 4: auxiliary frequency source B and master and slave operation result switching		
		Bit	Frequency source main and auxiliary operation relationship	
0 : main + auxiliary		1 : main-auxiliary		
2 : max		3 : min.		

Use this parameter to select the frequency reference channel. The frequency reference is achieved by a combination of the main frequency source A and the auxiliary frequency source B (Pic 6-2)

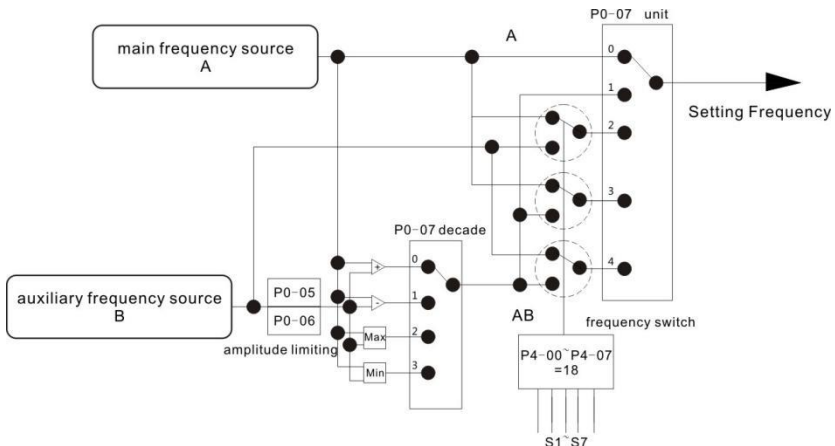

When the frequency source is selected as the main and auxiliary operation, the offset frequency can be set by P0-21, and the offset frequency is superimposed on the main and auxiliary operation results to flexibly cope with various requirements.

P0-08	Preset the set frequency	Factory default	50.00Hz
-------	--------------------------	-----------------	---------

	Set range	0.00 ~ max frequency (The frequency source selection mode is valid for the digital setting)
--	-----------	---

When the frequency source is selected as "digital setting", the function code value is the frequency of the inverter.

P0-09	Motor rotation	Factory default	0
	Set range	0 : same direction	1 : opposite direction

By changing the function code, you can change the motor wiring without changing the motor to achieve the purpose of changing the motor, its role is equivalent to adjust the motor (U, V, W) any two lines to achieve the direction of rotation of the motor.

Note: After the parameter is initialized, the motor running direction will return to its original state. For the system after debugging is strictly prohibited to change the motor steering occasions with caution.

P0-10	Max output frequency	Factory default	50.00 Hz
	Set range	50.00Hz ~ 500.00Hz	

DSI-200 analog input, high-speed pulse input (S5), multi-segment instructions, as the frequency of the respective 100.0% are relative to the P0-10 calibration.

P0-11	Running frequency upper limit frequency selection	Factory default	0
	Set range	0 : P0-12 settings 1 : AI1 2 : AI2 3 : AI3 4:High speed pulse input (S5) 5 : Communication settings	

Defines the source of the upper limit frequency. The upper limit frequency can be from the digital setting (P0-12), or from the analog input, the high speed pulse input setting or the communication reference.

When using the analog (AI1, AI2, AI3) setting, high-speed pulse input setting (S5) or communication setting, similar to the main frequency source, see P0-03 introduction.

For example, when the torque control mode is adopted in the winding control field, the upper limit frequency can be set by analog quantity in order to avoid the phenomenon of "speeding". When the inverter is running to the upper limit frequency value, the inverter will run at the upper limit frequency.

P0-13	Running frequency upper limit offset	Factory default	0.00Hz
	Set range	0.00Hz ~ max frequency P0-10	

When the upper limit frequency is set for analog or high speed pulse, P0-13 is used as the offset of the set value, and the offset frequency is superimposed on the upper limit frequency value of P0-11 setting as the final upper limit frequency setting value.

P0-14	Running frequency lower	Factory default	0.00Hz
	Set range	0.00Hz ~ upper frequency P0-12	

When the frequency command is lower than the lower limit of P0-14, the inverter can be stopped, run at the lower limit frequency or run at zero speed. What mode of operation can be used through P8-14 (setting frequency lower than lower frequency operation mode) Set up.

P0-17	acceleration time 1	Factory default	Motor type confirmation
	Set range	0s ~ 65000s (P0-19=0)	
P0-18	Deceleration 1	Factory default	Motor type confirmation
	Set range	0s ~ 65000s (P0-19=0)	

The acceleration time refers to the time required for the frequency converter to change from zero frequency to acceleration / deceleration reference frequency (P0-25), see t1 in Figure 6-3. Deceleration time refers to the frequency converter from the acceleration and deceleration reference frequency (P0-25 determined), deceleration to zero frequency required time, see Figure 6-3

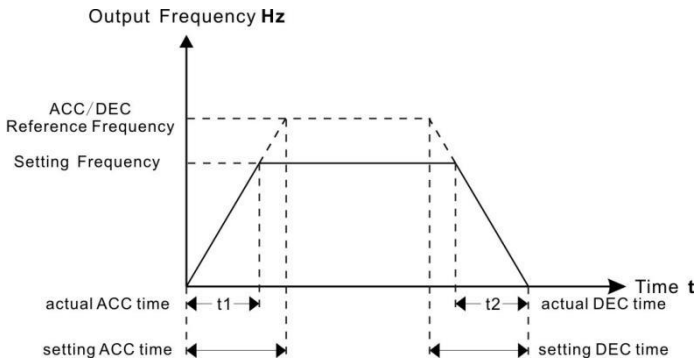

Figure6-3 acceleration/Deceleration time shows diagram

DSI-200 provides four groups of acceleration and deceleration time, the user can use the digital input terminal S switch selection, four sets of acceleration and deceleration time through the following function code settings:

Group one : P0-17、 P0-18;

Group two : P8-03、 P8-04;

Group three : P8-05、 P8-06;

Group four : P8-07、 P8-08;

P0-21	Combined frequency of auxiliary frequency source	Factory default	0.00Hz
	Set range	0.00Hz ~ max frequency P0-10	

This function code is valid only when the frequency source is selected as the master and slave operation.

When the frequency source is the main auxiliary operation, P0-21 is used as the bias frequency, and the result of the main and auxiliary operation is superimposed as the final frequency setting value, so that the frequency setting can be more flexible.

P0-22	Frequency command resolution	Factory default	2
	Set range	1 : 0.1Hz	2 : 0.01Hz

This parameter is used to determine the resolution of all frequency dependent function codes.

P0-23	Digital setting frequency stop memory selection	Factory default	1
	Set range	0 : non-memory	1 : memory

This function is valid only when the frequency source is digital.

"No memory" means that the digital setting frequency value is restored to the value of P0-08 (preset frequency) after the inverter is stopped, and the frequency correction of the keyboard ▲, ▼ key or terminal UP and DOWN is cleared.

"Memory" means that the digital setting frequency is set to the set frequency of the last stop time when the inverter is stopped, and the frequency correction of the keypad ▲, ▼ key or terminal UP and DOWN remains valid.

P0-25	Acceleration / deceleration time reference frequency	Factory default	0
	Set range	0 : max frequency (P0-10) 2 : 100Hz	1 : set frequency

Acceleration/deceleration time, is from zero to P0-25 set the frequency between the acceleration and deceleration time, Figure6-3 for the acceleration and deceleration time diagram.

When P0-25 = 1, the acceleration / deceleration time is related to the set frequency. If the frequency is changed frequently, the acceleration of the motor is changed, and the application needs attention.

P0-26	Run time frequency command UP / DOWN reference	Factory fault	0
-------	--	---------------	---

	Set range	0 : operating frequency 1 : set frequency
--	-----------	--

This parameter is valid only when the frequency source is digital.

Used to determine the keyboard ▲, ▼ key or terminal UP/ DOWN action, the way to amend the set frequency, that is, the target frequency is based on the operating frequency increase or decrease, or in the set frequency based on the increase or decrease.

The difference between the two settings, the inverter is in the acceleration and deceleration process is obvious, that is, if the inverter running frequency and set the frequency is different, the different options vary widely.

P0-27	The run command is tied to the main frequency source A command selection		Factory fault	000
	Set range	bit	Operation panel command Bind frequency source selection	
		0 : No bundles 1 : Numeric setting frequency source 2 : AI1 3 : AI2 4 : AI3 5 : High speed pulse input setting (S5) 6 : Multi - step instructions 7 : simple PLC 8 : PID 9 : Communication given		
		Ten	The terminal command binds the frequency source selection (0 ~ 9 , the same as bit)	
	hundred	Communication command binding frequency source selection (0 ~ 9 , the same as bit)		

Define the combination of three run command channels and nine frequency reference channels to facilitate synchronous switching.

The meaning of the above frequency reference channel is the same as the main frequency source A selection P0-03, see the P0-03 function code description.

Different run command channels can be bundled with the same frequency given channel.

When the command source has a bundled frequency source, the set frequency source of P0-03 ~ P0-07 is no longer active when the command source is valid.

P1 group First motor parameter

Function code	Function definition	Factory default	Set range	parameter
P1-00	Motor 1 type choose	0	0	Ordinary asynchronous motor
			1	Variable frequency induction motor
P1-01	Motor 1 rated power	Model determined	0.1kW ~ 1000.0kW	P1-00 ~ P1-05 is the motor nameplate parameter. In the use of V / F, SVC, FVC control, in order to obtain better control performance, the need for motor parameters of self-learning, and the correct set of motor nameplate parameters
P1-02	Motor 1 rated voltage	Model determined	1V ~ 2000V	

				Closely related.
P1-03	Motor 1 rated current	Model determined	0.01A ~ 655.35A (AC motor frequency \leq 55kW)	
P1-04	Motor 1 rated frequency	Model determined	0.01Hz ~ max frequency	
P1-05	Motor 1 rated rpm	Model determined	1rpm ~ 65535rpm	

P1-06	Asynchronous motor 1 stator power Resistance	Model determined	0.001 Ω ~ 65.535 Ω (AC motor frequency \leq 55kW)	<p>P1-06 ~ P1-10 is the parameters of the induction motor, can be obtained through the motor self-learning. Among them, the asynchronous part of the asynchronous parameters of self-learning can only get P1-06 ~ P1-08 three parameters, asynchronous machine dynamic complete learning can get P1-06 ~ P1-10, you can also get the encoder phase sequence P1-30. If the scene is not on the motor self-learning, according to the motor manufacturers to provide the parameters, enter the corresponding function code.</p>
P1-07	Asynchronous motor 1 rotor electric Resistance	Model determined	0.001 Ω ~ 65.535 Ω (AC motor frequency \leq 55kW)	
P1-08	Asynchronous motor 1 leakage inductance	Model determined	0.01mH ~ 655.35mH (AC motor frequency \leq 55kW)	
P1-09	Asynchronous motor 1 mutual inductance	Model determined	0.1mH ~ 6553.5mH (AC motor frequency \leq 55kW)	
P1-10	Asynchronous motor 1 No-load current	Model determined	0.01A ~ P1-03 (AC motor frequency \leq 55kW)	
P1-27	Number of encoder lines	1024	1 ~ 65535	

P1-30	ABZ incremental 1AB Phase sequence	0	0: Forward 1: Reverse	0: A phase advance when motor is running forward (B phase advance when motor reverses) 1: When the motor is running forward B phase advance (the motor reverses the A phase ahead)
P1-36	Speed feedback PG off Line detection time	0.0s	0.0s : non-move 0.1s ~ 10.0s	Used to set the encoder break fault detection time, when set to 0.0s, the inverter does not detect the encoder break fault. When the inverter detects a disconnection fault and the duration exceeds P1-36 setting time, the inverter will alarm FU20.

P2 group Vector control parameters

P2 group function code is only valid for vector control, invalid for VF control.

P2-00	Speed loop proportional gain	Factory default	30
	Set range	1 ~ 100	
P2-01	Speed loop integration time 1	Factory default	0.50s
	Set range	0.01s ~ 10.00s	
P2-02	Switch the low frequency 1	Factory default	5.00Hz
	Set range	0.00 ~ P2-05	
P2-03	Speed loop proportional gain 2	Factory default	20
	Set range	0 ~ 100	
P2-04	Speed loop integration time 2	Factory default	1.00s
	Set range	0.01s ~ 10.00s	
P2-05	Switch high frequency	Factory	10.00Hz
	Set range	P2-02 ~ max output frequency	

Inverter running at different frequencies, you can choose a different speed loop PI parameters. When the operating frequency is less than the switching frequency 1 (P2-02), the speed loop PI adjustment parameters are P2-00 and P2-01. When the operating frequency is greater than the switching frequency 2, the speed change PI adjustment parameters are P2-03 and P2-04. The speed loop PI parameter between the switching frequency 1 and the switching frequency 2 is a two-way PI parameter linear switching, as shown in Figure 6-4

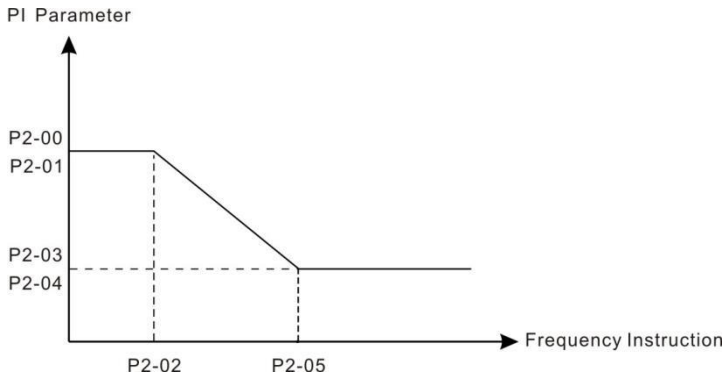

Figure 6-4 PI Parameter diagram

By setting the speed factor and the integration time of the speed regulator, you can adjust the velocity dynamic response characteristics of the vector control.

Increase the proportional gain, reduce the integration time, can speed up the dynamic response of the speed loop. But the proportional gain is too large or the integration time is too small may cause the system to oscillate. Suggested adjustment method is:

If the factory parameters cannot meet the requirements, the parameters in the factory value on the basis of fine-tuning, first increase the proportional gain to ensure that the system does not oscillate; and then reduce the integration time, the system has a faster response characteristics, overshoot and smaller.

Note: If the PI parameter is set incorrectly, it may cause the speed overshoot to be too large. Even in the overshoot when the over voltage failure

P2-06	Vector control slip gain	Factory default	100%
	Set range	50% ~ 200%	

For speed sensor less vector control, this parameter is used to adjust the speed accuracy of the motor: when the motor is loaded with low speed, the parameter is increased.

For speed sensor vector control, this parameter can adjust the size of the output current of the inverter under the same load.

P2-07	SVC speed feedback filter time constant	Factory default	0.000s
	Set range	0.000s ~ 0.100s	

SVC over-feedback filter time only when P0-01=0 into effect, increase P2-07 can improve the motor stability, but the dynamic effect becomes weak, otherwise the corresponding dynamic enhancement, but too small will cause the motor shock, so no adjustment.

Speed loop filter time constant is small, the inverter output torque may fluctuate significantly, but the speed of response fast.

P2-09	Torque upper limit source in speed	Factory default	0
	Set range	0 : P2-10 1 : AI1 2 : AI2 3 : AI3 4 : High speed pulse input setting (S5)	

		5 : Communication settings 6 : MIN(AI1 , AI2) 7 : MAX(AI1 , AI2)	
P2-10	Speed setting mode of torque upper limit digital setting	Factory default	150.0%
	Set range	0.0% ~ 200.0%	
P2-11	Speed control mode Torque upper limit command channel selection (power generation)	Factory default	0
	Set range	0 : P2-10 1 : AI1 2 : AI2 3 : AI3 4: High speed pulse input setting(S5) 5 : Communication settings 6 : MIN(AI1 , AI2) 7 : MAX(AI1 , AI2) 8 : Function code P2-12 setting	
P2-12	Speed control mode Torque upper limit Digital setting (power generation)	Factory default	150.0%
	Set range	0.0% ~ 200.0%	

In the speed control mode, the maximum value of the inverter output torque is controlled by the torque upper limit source.

P2-09 is used to select the set value of the upper limit of the torque, when the analog, high-speed pulse, communication settings corresponding to the set.

100% corresponds to P2-10, and P2-10 100% of the inverter rated current.

AI1, AI2, AI3 settings see P4 group AI curve related introduction (by P4-33 select the respective curve)

High speed pulse see P4-28 ~ P4-32 introduction

Select the communication settings, if the current point-to-point communication from the machine and receive data as a torque given, the direct transmission by the host torque digital settings, see A8 group point-to-point communication description; otherwise, by the host computer through the communication address 0 × 1000 write -100.00% to 100.00% of the data, of which 100.00% corresponds to P2-10.

P2-13	Excitation adjustment proportional gain	Factory default	2000
	Set range	0 ~ 20000	
P2-14	Excitation adjustment integral gain	Factory default	1300
	Set range	0 ~ 20000	

P2-15	Torque adjustment proportional gain	Factory default	2000
	Set range	0 ~ 20000	
P2-16	Torque adjustment integral gain	Factory default	1300
	Set range	0 ~ 20000	

Vector control current loop PI adjustment parameters, the parameters in the asynchronous machine after the self-learning will automatically get, generally do not need to modify.

Need to be reminded that the current loop integral regulator, not the use of integral time as a dimension, but directly set the integral gain. The current loop PI gain setting is too large, which may cause the entire control loop to oscillate. Therefore, when the current oscillation or torque fluctuation is large, the PI proportional gain or integral gain can be reduced manually.

P2-22	Power generation limit is	Set range	0
	Set range	0 : no effect	1 : effect
P2-23	Power generation limit	Factory default	Motor ensure
	Set range	0.0~200.0%	

For the cam load, rapid acceleration and deceleration, load sudden drop and other applications, and not using the braking resistor, you can enable the power generation limit (set P2-22 = 1), effectively reduce the motor brake process bus voltage Red, to avoid the occurrence of over-voltage failure. The upper limit of the power generation P2-23 is the percentage of the rated power of the motor and still occurs when the power limit is enabled. When over voltage, adjust P2-23 downwards.

P3 group V/F Control parameters

This function code is valid only for V / F control and is not valid for vector control.

V / F control suitable for fans, pumps and other general load, or a frequency converter with multiple motors, or inverter power and motor power difference between the larger applications.

P3-00	V/F Curve setting	Factory default	0
	Set range	0 : line V/F 1 : Multipoint V/F 2 : square V/F 3 : 1.2 times V/F 4 : 1.4 times V/F 6 : 1.6 times V/F 8 : 1.8 times V/F 9 : Reserved 10 : VF Completely separate mode 11 : VF Semi-separation mode	

- 0: Straight line V / F. Suitable for ordinary constant torque load.
- 1: multi point V / F. Suitable for dehydration machines, centrifuges and other special load. At this time by setting P3-03 ~ P3-08 parameters, you can get any VF relationship curve.

- 2: square V / F. Suitable for fans, pumps and other centrifugal load.
- 3 ~ 8: between the linear VF and square VF VF relationship between the curve.
- 10: VF complete separation mode. At this time the output frequency of the inverter and the output voltage are independent of each other, the output frequency is determined by the frequency source, and the output voltage is determined by P3-13 (VF separation voltage source).
- VL complete separation mode, the general application of induction heating, inverter power supply, torque motor control and other occasions.
- 11 : VF Semi-separation mode.

In this case V and F are proportional, but the proportional relationship can be set by the voltage source P3-13, and the relationship between V and F is also related to the rated voltage of the motor of P1 group and the rated frequency.

Assuming that the voltage source input is X (X is a value of 0 to 100%), the relationship between the inverter output voltage V and the frequency F is:

$$V / F = 2 * X * (\text{motor rated voltage}) / (\text{motor rated frequency})$$

P3-01	Torque boost	Factory default	Motor ensure
	Set range	0.0% ~ 30%	
P3-02	Torque boost cutoff	Factory default	50.00Hz
	Set range	0.00Hz ~ max output frequency	

In order to compensate for the V / F control low frequency torque characteristics, the low frequency inverter output voltage to do some lifting compensation. But the torque boost setting is too large, the motor is easy to overheat, the inverter is easy to overcurrent.

It is recommended to increase this parameter when the load is heavy and the motor starting torque is not enough. The torque boost can be reduced when the load is light.

When the torque boost is set to 0.0, the inverter will be automatically boosted, and the inverter will automatically calculate the required torque boost according to the parameters such as motor stator resistance.

Torque boost torque cutoff frequency: Under this frequency, the torque boost torque is valid, beyond this set frequency, torque boost failure, as shown in Figure 6-5.

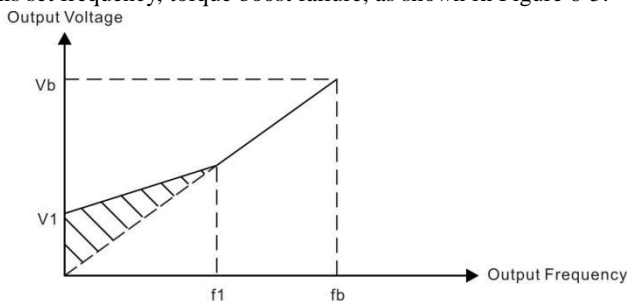

V1: manual torque boost voltage f1: Manual torque boost cutoff frequency
 Vb: maximum output voltage fb: Rated operating frequency

Figure 6-5 Manual torque boost diagram

P3-03	Multipoint VF frequency point P1	Factory default	0.00Hz
	Set range	0.00Hz ~ P3-05	
P3-04	Multi point VF voltage point V1	Factory default	0.0%
	Set range	0.0% ~ 100.0%	
P3-05	Multi point VF frequency point P2	Factory default	0.00Hz
	Set range	P3-03 ~ P3-07	
P3-06	Multi point VF voltage point V2	Factory default	0.0%
	Set range	0.0% ~ 100.0%	
P3-07	Multi point VF frequency point F3	Factory default	0.00Hz
	Set range	P3-05 ~ motor rated frequency (P1-04) Notes : No.2 motor rated frequency A2-04	
P3-08	Multi point VF voltage point V3	Factory default	0.0%
	Set range	0.0% ~ 100.0%	

P3-03 ~ P3-08 six parameters define multi-segment V / F curve.

Multi-point V / F curve according to the motor load characteristics to set, it should be noted that the relationship between the three voltage points and frequency points must meet: $V1 < V2 < V3$, $F1 < F2 < F3$. Figure 6-6 for the multi-point VF curve set diagram.

Low voltage setting at high frequencies may cause the motor to overheat or burn, and the frequency converter may over-current stall or over current protection.

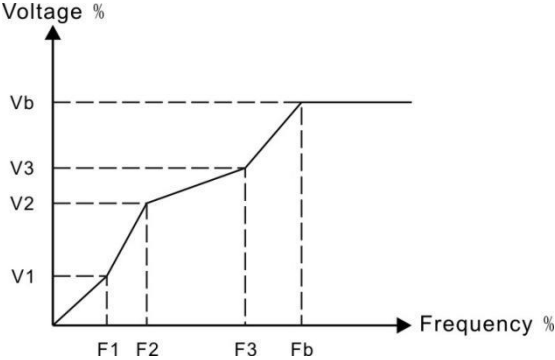

V1-V3 : Multi-speed V / F Section 1-3 Voltage percentage

Vb : motor rated voltage

F1-F3 : Multi-step speed V / F Division 1-3 Frequency percentage

Fb : Rated motor operating frequency

Figure 6-6 multi point V/F Curve setting diagram

P3-10	VF Over-excitation	Factory default	64
	Set range	0 ~ 200	

In the inverter deceleration process, the over-excitation control can inhibit the bus voltage rise, to avoid over-voltage failure. The greater the over-excitation gain, the stronger the suppression effect.

It is necessary to increase the over discharge gain when the inverter decelerates the over voltage alarm. But the over-excitation gain is too large, easily lead to increased output current, the need to trade in the trade-off.

In the case of a small increase in inertia, there is no voltage rise in the motor deceleration, it is recommended to set the over-excitation gain of 0; for the case of a braking resistor, it is also recommended that the over-excitation gain be set to zero.

P3-11	VFO oscillation suppression gain	Factory default	40
	Set range	0 ~ 100	

The gain of the selection method is to effectively suppress the oscillation under the premise of taking as small as possible, so as not to adversely affect the VF operation. Select this gain to 0 when there is no oscillation of the motor. Only when the motor is significantly oscillating, only need to increase the gain, the greater the gain, the more obvious inhibition of oscillation.

When using the suppression oscillation function, the motor rated current and no-load current parameters are required to be accurate, otherwise the VF oscillation suppression effect is not good.

P3-13	VF Separate voltage source	Factory default	0
	Set range	0 : number setting (P3-14) 1 : AI1 2 : AI2 3 : AI3 4 : High speed pulse input setting (S5) 5 : Multi - step instructions 6 : Simple PLC 7 : PID 8 : Communication given	
		100.0% Corresponds to the motor rated voltage (P1-02、 A2-02)	
P3-14	VF Separate voltage digital setting	Factory default	0V
	Set range	0V ~ motor rated voltage	

Separation is generally used in induction heating, inverter power supply and torque motor control and other occasions.

When selecting VF separation control, the output voltage can be set via function code P3-14, or from analog, multi-step instructions, PLC, PID or communication reference. When the non-digital setting is used, each set of 100% corresponds to the rated voltage of the motor. When the percentage of analog output is negative, the set absolute value is used as the effective setting value.

- 0 : number setting (P3-14)

The voltage is set directly from P3-14

- 1 : AI1 2 : AI2 3 : AI3

- The voltage is determined by the analog input terminal.

- 4、 High speed pulse setting (S5)

The voltage reference is given by the terminal pulse.

Pulse given signal specifications: voltage range 9V ~ 30V, the frequency range 0 kHz ~ 100 kHz.

- 5、 Multi - step instructions

When the voltage source is a multi-segment instruction, set the P4 group and PC group parameters to determine the correspondence between the given signal and the given voltage.

- 6、 Simple PLC

When the voltage source is a simple PLC, you need to set the PC group parameters to determine the given output voltage

- 7、 PID

- Output voltage according to PID closed loop. For details, refer to the PA group PID introduction.

- 8、 Communication given

The voltage is given by the host computer by means of communication.

The VF separation voltage source selection is similar to the frequency source selection mode, see the description of the P0-03 main frequency source selection. Among them, all kinds of selection corresponding to the set of 100.0%, refers to the voltage rated voltage (take the corresponding set value should be absolute value)

P3-15	VF voltage acceleration time	Factory default	0.0s
	Set range	0.0s ~ 1000.0s	

VF separation rise time refers to the output voltage from 0V to the motor rated voltage required time. As shown in Figure 6-7:

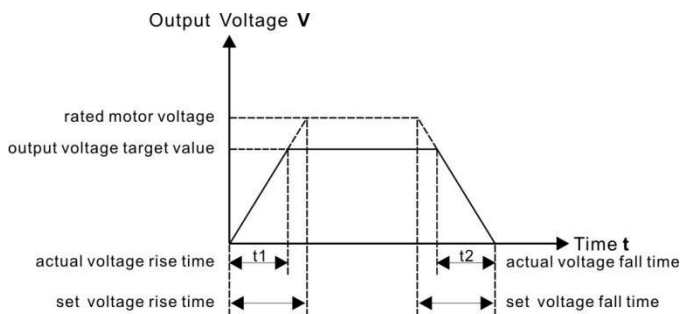

Figure 6-7 V/F Separation diagram

P4 Group Input Terminal

EV510 series inverter comes standard with seven multi-function digital input terminals (where S5 can be used as high-speed pulse input terminal), three analog input terminals, two relay outputs, one optocoupler collector output.

Function code	Name	Factory default	Notes
P4-00	S1 Terminal function selection	1 (Forward run)	Standard
P4-01	S2 Terminal function selection	4 (Moving forward)	Standard
P4-02	S3 Terminal function selection	9 (Fault reset)	Standard
P4-03	S4 Terminal function selection	12 (Multi-speed 1)	Standard
P4-04	S5 Terminal function selection	13	Standard

These parameters are used to set the function of the digital multi-function input terminal. The functions that can be selected are shown in the following table:

Set value	Function	Description
0	Non-function	The unused terminal can be set to "no function" to prevent malfunction.
1	Forward running (FWD)	Through the external terminal to control the inverter forward and reverse.
2	Reverse run (REV)	
3	Three-wire operation control	Through this terminal to determine the inverter running mode is three-wire control mode. For details, please refer to Function code P4-11 ("terminal command mode").
4	Moving forward (FJOG)	FJOG for the jog forward run, RJOG for the jog reverse run. Jogging frequency,
5	Reversal point	Refer to the function codes P8-00, P8-01, P8-02 for the acceleration / deceleration time.

Set value	Function	Description
	(RJOG)	
6	Terminal UP	When the frequency is given by the external terminal, the frequency is increased and decremented. The frequency source is set to When the digit is set, adjust the set frequency up and down.
7	Terminal DOWN	
8	Freely stop	The inverter blocks the output, and the motor stop process is not controlled by the inverter, This way with. The meaning of free parking as described in P6-10 is the same.
9	Fault reset (RESET)	Use the terminal to perform a fault reset function. With the same function as the RESET key on the keyboard. Use this function to enable remote fault reset.
10	Working stop	The drive decelerates, but all operating parameters are memorized. Such as PLC parameters, wobble parameters, PID parameters. When the terminal signal disappears, the inverter returns to the running state before stopping.
11	External fault normally open input	When the signal is sent to the inverter, the inverter reports fault FU15, and according to the fault protection action side (Refer to function code P9-47 for details).
12	Multi-speed	Through the four terminals of the 16 states, to achieve 16 speed or 16 other instructions The setting. See Table 1 for details.
13	Multi-speed terminal 2	
14	Multi-speed	
15	Multi-speed	
16	Acceleration/ deceleration time selection terminal 1	Through the four terminals of the four states, to achieve four kinds of acceleration and deceleration time selection, the details
17	Acceleration/ deceleration time	See Schedule 2

Set value	Function	Description
	selection terminal 2	
18	Frequency source switching	Used to switch between different frequency sources. Depending on the frequency source selection function code (P0-07) is set when setting between two frequency sources
19	UP/DOWN set 0 (terminal, keyboard)	When the frequency is given as a digital frequency reference, this terminal can clear the terminal UP / DOWN or Keyboard UP / DOWN changes the frequency value, so that the given frequency to restore the value set to P0-08.
20	Run command to switch the terminal 1	When the run command is set to terminal control (P0-02 = 1), this terminal can be terminal controlled with Keyboard control switch.
21	Acceleration/ deceleration is prohibited	Ensure that the frequency converter is not affected by external signals (except for the stop command), to maintain the current output frequency.
22	PID stop	PID Temporary failure, the inverter to maintain the current output frequency, no longer the frequency of the source PID adjustment.
23	PLC statue reset	When the PLC is paused during execution, the inverter can be restored to this time through this terminal Simple PLC initial state.
24	Pendulum pause	The frequency converter outputs at the center frequency. The wobble function is paused.
25	Register input	The input terminal of the count pulse.
26	Register reset	The counter status is cleared.
27	Length count input	Length count input terminal.
28	Length reset	The length is cleared
29	Torque control disabled	Prohibit the inverter torque control, the inverter into the speed control mode
30	High speed pulse input setting (Only valid for S5)	S5 as a high-speed pulse input terminal function.
31	keep	keep

Set value	Function	Description
32	Immediate DC braking	When the terminal is valid, the inverter will switch directly to the DC braking state
33	External fault normally closed input	When the external fault normally closed signal into the inverter, the inverter reported failure EF and shutdown.
34	Frequency modification enabled	If the function is set to active, the frequency converter does not respond to the frequency change when the frequency changes. until the terminal status is invalid.
35	PID the direction of action is reversed	When the terminal is active, the direction of PID action is opposite to that set by PA-03
36	External parking terminal 1	When the keyboard is in control, the inverter can be used to stop the inverter, which is equivalent to the STOP key on the keyboard.
37	Run command to switch the terminal 2	Used for switching between terminal control and communication control. If the command source is selected for terminal control, The system is switched to communication control when the terminal is valid;
38	PID Points are suspended	When the terminal is active, the integral adjustment function of the PID is halted, but the PID proportional and differential adjustment functions are still active.
39	Frequency source A and preset frequency switching	When the terminal is active, the frequency source A is replaced with the preset frequency (P0-08)
40	Frequency source B and preset frequency switching	When the terminal is active, the frequency source B is replaced with the preset frequency (P0-08)
41	Motor selection terminal 1	The terminal is valid, then switch to the second motor, A2 group motor parameters are valid;
42	keep	keep
43	PID Parameter switch	PA-15 ~ PA-07 is used when the PID parameter is used when the PID parameter is the S terminal (PA-18 = 1) and the terminal is invalid.
44	User defined fault 1	When user fault 1 and 2 are valid, the inverter will alarm FU1 and FU2 respectively. The inverter will select the action mode selected by P9-49 according to the fault protection action.
45	User defined fault 2	

Set value	Function	Description
46	Speed control / torque control switching	The frequency converter is switched between torque control and speed control mode. When the terminal is inactive, the inverter operates in the mode defined by A0-00 (speed / torque)
47	Brake	When the terminal is active, the inverter stops at the fastest speed, and the current is at the set current limit during the stop. This function is used to meet the requirements of the inverter as soon as possible when the system is in a state of emergency.
48	External parking terminal 2	In any control mode (panel control, terminal control, communication control), the terminal So that the inverter deceleration stop, then deceleration time is fixed to deceleration time 4.
49	Deceleration of DC braking	When the terminal is active, the inverter first decelerates to the stop DC brake start frequency, and then switches to DC braking state.
50	This run time is cleared	When the terminal is valid, the time of the inverter running this time is cleared, this function needs to be set (P8-42) and the run time to reach (P8-53) with the use.
51	Two-wire/ three-wire switch	Used to switch between two-wire and three-wire controls. If P4-11 is set to 0 (two-wire type 1), the function of the terminal is valid, switch to three-wire 1. If P4-11 is set to 1 (two-wire type 2), the function of the terminal is valid, switch to three-wire 2. If P4-11 is set to 2 (three-wire type 1), the function of the terminal is valid, switch to two-wire 1. If P4-11 is set to 3 (three-wire type 2), the function of the terminal is valid, switch to two-wire 2.
52	Reverse frequency is disabled	When the terminal is active, the inverter actually set the frequency to 0 even if the reverse frequency is set. And the reverse frequency disabled (P8-13) function the same.

Schedule 1 Multi-segment Instruction Function Description

4 multi-stage instruction terminals can be combined into 16 states, 16 of which correspond to 16 command settings. As shown in Table 1:

K ₄	K ₃	K ₂	K ₁	Instruction set	Corresponding
OFF	OFF	OFF	OFF	Multi - step instructions 0	PC-00
OFF	OFF	OFF	ON	Multi - step instructions 1	PC-01
OFF	OFF	ON	OFF	Multi - step instructions 2	PC-02
OFF	OFF	ON	ON	Multi - step instructions 3	PC-03

OFF	ON	OFF	OFF	Multi - step instructions 4	PC-04
OFF	ON	OFF	ON	Multi - step instructions 5	PC-05
OFF	ON	ON	OFF	Multi - step instructions 6	PC-06
OFF	ON	ON	ON	Multi - step instructions 7	PC-07
ON	OFF	OFF	OFF	Multi - step instructions 8	PC-08
ON	OFF	OFF	ON	Multi - step instructions 9	PC-09
ON	OFF	ON	OFF	Multi - step instructions 10	PC-10
ON	OFF	ON	ON	Multi - step instructions 11	PC-11
ON	ON	OFF	OFF	Multi - step instructions 12	PC-12
ON	ON	OFF	ON	Multi - step instructions 13	PC-13
ON	ON	ON	OFF	Multi - step instructions 14	PC-14
ON	ON	ON	ON	Multi - step instructions 15	PC-15

When the frequency source is selected as multi-step speed, the function code PC-00 ~ PC-15 100.0%, corresponding to the maximum frequency P0-10.

Multi-segment instructions, in addition to the multi-speed function, can also be used as a given source for PID or as a voltage source for VF separation control to meet the need to switch between different set points.

Schedule 2 Acceleration / deceleration time selection terminal function description

Terminal 2	Terminal 1	Acceleration or deceleration time selection	Corresponding parameters
OFF	OFF	acceleration time 1	P0-17、 P0-18
OFF	ON	acceleration time 2	P8-03、 P8-04
ON	OFF	acceleration time 3	P8-05、 P8-06
ON	ON	acceleration time 4	P8-07、 P8-08

P4-10	S1~S7 Filter time	Factory default	0.010s
	Set range	0.000s ~ 1.000s	

Set the software filter time for S1 to S7 terminal status. If the use of occasions, input terminals susceptible to interference caused by malfunction, this parameter can be increased to enhance the anti-jamming capability. But the increase in the filter time will cause the S-terminal response to slow.

P4-11	The terminal controls the operating mode	Factory default	0
	Set range	0 : two wires 1 1 : two wires 2 2 : three wires 1 3 : three wires 2	

This parameter defines four different ways of controlling the drive to run through an

external terminal.

Note: For convenience of explanation, the S1, S2, and S2 terminals of the multi-function input terminals S1 to S10 are selected as external terminals. That is, by setting the value of P4-00 ~ P4-02 to select the functions of S1, S2 and S2 three terminals. For details, please refer to the setting range of P4-00 ~ P4-09.

0: Two-wire mode 1: This mode is the most commonly used two-wire mode. By the terminal S1, S2 to determine the positive and reverse operation of the motor. The function is set as follows:

Function	Name	Set range	Function description
P4-11	Terminal	0	Two wire 1
P4-00	S1 Terminal function selection	1	Forward run (FWD)
P4-01	S2 Terminal function selection	2	Reverse run (REV)

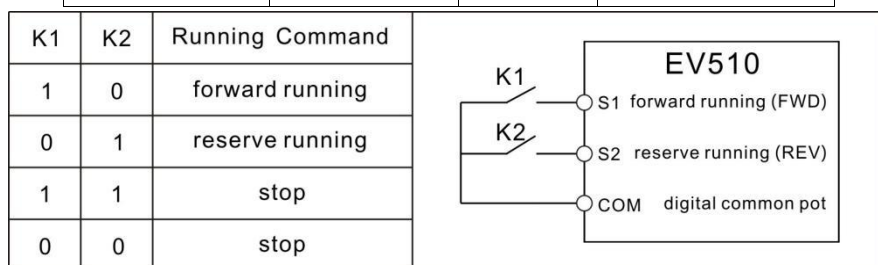

Figure 6-8 Two-line mode 1

As shown in the figure above, in this control mode, K1 is closed and the inverter is running forward. K2 closed reverse, K2, K1 closed or disconnected at the same time, the inverter stops running.

3: Three-wire control mode 2: When this mode is used, S3 is enable terminal, the S1 terminal function is the operation enable terminal, and the S2 terminal function determines the running direction. The function is set as follows

Function	Name	Set number	Function
P4-11	Terminal command mode	3	Three wires 2
P4-00	S1 Terminal function selection	1	Run enable
P4-01	S2 Terminal function selection	2	Positive and negative direction of operation

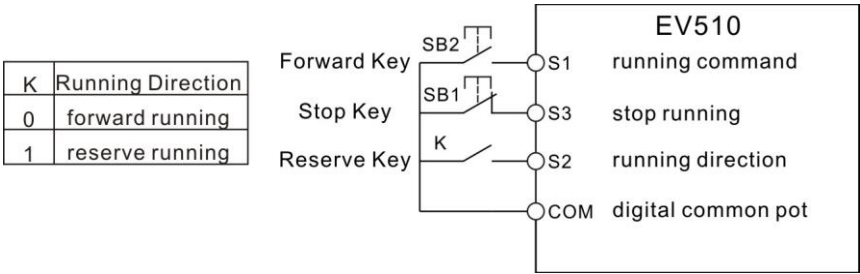

Figure 6-9 three wires model 2

As shown in the figure above, the control mode in K1 closed state, K2 disconnect the inverter forward. K2 closed inverter reverse; K1 off, the inverter stops running.

2: three-wire control mode 1: This mode S3 to enable the terminal, the direction of the control by the S1, S2

Function setting as follow shows :

Function	Name	Set value	Function description
P4-11	Terminal order way	2	Three wires 1
P4-00	S1 terminal function choose	1	Forward running (FWD)
P4-01	S2 terminal function choose	2	Reverse running (REV)

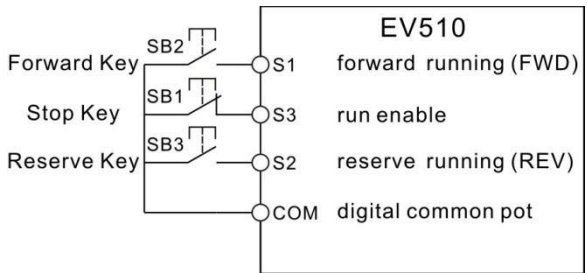

Figure 6-10 three wire operation control 1

As shown in the above figure, the control mode is in the SB1 button closed state, press the SB2 button inverter forward, press the SB3 button inverter reverse, SB1 button off instantaneous inverter shutdown. Normal start and run, must keep the SB1 button closed state, SB2, SB3 button command in the closing action along the entry into force, the inverter running state to the three buttons the last button action prevail.

3: three-wire control mode 2: S3 of this mode to enable the terminal, run the command given by the S1, the direction determined by the state of S2.

Function setting as follow :

Function	Name	Set value	Function description
P4-11	Terminal function	3	THREE PHASE 2

P4-00	S1 Terminal function choose	1	RUNNING
P4-01	S2 Terminal function choose	2	Forward and reverse direction of operation.
P4-02	S3 Terminal function choose	3	Three - wire operation control

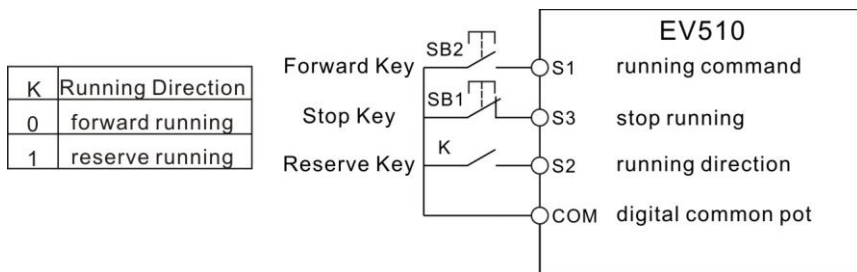

Figure 6-11 Three - wire control mode 2

As shown in the figure above, the control mode is in the SB1 button closed state, press the SB2 button inverter running, K disconnect the inverter forward, K closed inverter reverse; SB1 button off instantaneous inverter shutdown. During normal startup and operation, the SB1 button must be closed and the command of the SB2 button will take effect at the closing action edge.

P4-12	Terminal UP/DOWN Frequency change rate	Factory default	1.00Hz/s
	Set range	0.01Hz/s ~ 65.535Hz/s	

For setting the terminal UP / DOWN to adjust the set frequency, the speed of the frequency change, that is, the amount of change per second.

P4-13	AI curve 1 min input	Factory default	0.00V
	Set range	0.00V ~ P4-15	
P4-14	AI Curve 1 minimum input corresponds to setting	Factory default	0.0%
	Set range	-100.00% ~ 100.0%	
P4-15	AI Curve 1 maximum input	Factory default	10.00V
	Set range	P4-13 ~ 10.00V	
P4-16	AI Curve 1 maximum input corresponds to setting	Factory default	100.0%
	Set range	-100.00% ~ 100.0%	
P4-17	AI1 Input filter time	Factory default	0.10s
	Set range	0.00s ~ 10.00s	

The function code is used to set the relationship between the analog input voltage and the set value it represents.

When the analog input voltage is greater than the set "maximum input" (P4-15), the analog voltage is calculated according to the "maximum input"; Similarly, when the analog input voltage is less than the set "minimum input" P4-13), the minimum input or 0.0% is calculated according to the setting of "AI lower than minimum input setting" (P4-34).

When the analog input is current input, 1mA current is equivalent to 0.5V voltage.

AI1 input filter time, used to set the AI1 software filter time, when the field analog is easy to be disturbed, please increase the filter time, so that the test simulation tends to be stable, but the larger the filter time on the analog test The response speed is slow, how to set the need to be based on the actual application of trade-offs.

In different applications, the meaning of the corresponding nominal value of 100.0% of the analog setting is different. Please refer to the description of each application section.

The following illustrations are two typical settings:

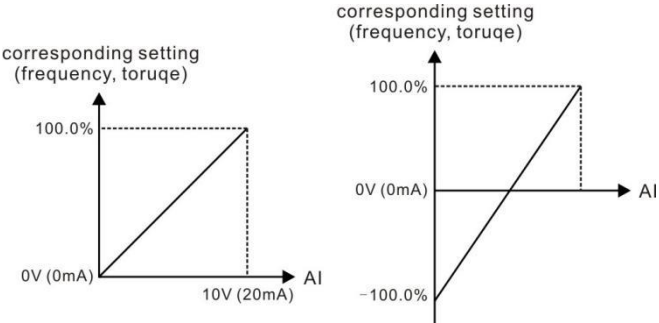

Figure 6-12 Correspondence between simulation reference and set

P4-18	AI Curve 2 minimum input	Factory	0.00V
	Set range	0.00V ~ P4-20	
P4-19	AI Curve 2 minimum input corresponds to setting	Factory default	0.0%
	Set range	-100.00% ~ 100.0%	
P4-20	AI Curve 2 maximum input	Factory	10.00V
	Set range	P4-18 ~ 10.00V	
P4-21	AI Curve 2 max input corresponds to setting	Factory default	100.0%
	Set range	-100.00% ~ 100.0%	
P4-22	AI2 Input filter time	Factory	0.10s
	Set range	0.00s ~ 10.00s	

For the function and use of curve 2, please refer to the description of curve 1.

P4-23	AI Curve 3 minimum input	Factory	0.00V
	Set range	0.00s ~ P4-25	

P4-24	AI Curve 3 minimum input corresponds to setting	Factory default	0.0%
	Set range	-100.00% ~ 100.0%	
P4-25	AI Curve 3 maximum input	Factory default	4.00V
	Set range	P4-23 ~ 10.00V	
P4-26	AI Curve 3 maximum input corresponds to setting	Factory default	100.0%
	Set range	-100.00% ~ 100.0%	
P4-27	AI3 Input filter time	Factory default	0.10s
	Set range	0.00s ~ 10.00s	

For the function and use of curve 3, please refer to the description of curve 1.

P4-28	High speed pulse minimum input	Factory default	0.00kHz
	Set range	0.00kHz ~ P4-30	
P4-29	High-speed pulse minimum input corresponding setting	Factory default	0.0%
	Set range	-100.00% ~ 100.0%	
P4-30	High speed pulse maximum input	Factory default	50.00kHz
	Set range	P4-28 ~ 50.00kHz	
P4-31	High-speed pulse maximum input corresponding setting	Factory default	100.0%
	Set range	-100.00% ~ 100.0%	
P4-32	Pulse input filter time	Factory default	0.10s
	Set range	0.00s ~ 10.00s	

This set of function codes is used to set the relationship between the S5 pulse frequency and the corresponding setting.

The pulse frequency can only be input to the inverter via the S5 channel.

The application of this group of functions is similar to curve 1, please refer to the description of curve 1.

P4-33	AI curve	Factory default	321
	Bit	AI1 curve choose	

	Set range	1 :curve 1(2 point ,see P4-13 ~ P4-16) 2 :curve 2(2 point ,see P4-18 ~ P4-21) 3 :curve 3(2 point ,see P4-23 ~ P4-26) 4 :curve 4(4 point ,see A6-00 ~ A6-07) 5 : curve 5 (4 point , see A6-08 ~ A6-15)
	Ten	AI2 curve choose (1 ~ 5 , same as above)
	Hundred	AI3 curve choose (1 ~ 5 , same as above)

The function code of the bit, ten, hundreds of bits were used to select, analog input AI1, AI2, AI3 corresponding to the set curve. 3 Each of the five types of curves can be selected for each analog input.

Curve 1, curve 2, curve 3 are 2-point curve, set in the P4 group function code, and curve 4 and curve 5 are 4-point curve, need to set in the A6 group function code.

P4-34	AI Below minimum input setting selection	Factory value	000
	Set range	Bit	AI1 Below minimum input setting selection
		0 : Corresponds to the minimum input setting	
		1 : 0.0%	
	Ten	AI2 Below minimum input setting selection (0 ~ 1 ,	
	hundred	AI3 Below minimum input setting selection (0 ~ 1 ,	

The function code is used to set the setting of the analog quantity when the analog input voltage is less than the set "minimum input".

The function code of the bit, ten, hundred, respectively, corresponding to the analog input AI1, AI2, AI3.

If the option is 0, when the AI input is lower than the "minimum input", the corresponding setting of the analog quantity is the curve "minimum input corresponding setting" (P4-14, P4-19, P4- twenty four).

If 1 is selected, the analog value is set to 0.0% when the AI input is below the minimum input.

P4-35	S1 delay time	Factory default	0.0s
	Set range	0.0s ~ 3600.0s	
P4-36	S2 delay time	Factory default	0.0s
	Set range	0.0s ~ 3600.0s	
P4-37	S3 delay time	Factory default	0.0s
	Set range	0.0s ~ 3600.0s	

Used to set the delay time for the inverter to change when the S-terminal status changes. Currently only S1, S2, S3 with the delay time to set the function.

P4-38	S1~S5 Terminal valid mode selection 1		Factory value	00000	
	Set range	Bit	S1 Terminal valid status setting		
		0 : Active high		1 : active low	
		Ten	S2 Terminal valid status setting (0 ~ 1 , see		
		Hundred	S3 Terminal valid status setting (0 ~ 1 , see		
		Thousand	S4 Terminal valid status setting (0 ~ 1 , see		
		Million	S5 Terminal valid status setting (0 ~ 1 , see		

Used to set the active status mode of the digital input terminal.

When the selection is active high, the corresponding S terminal is valid when connected to the GND, and the switch is invalid.

When the selection is active low, the corresponding S terminal is inactive with GND and is disabled.

P5 Group Output terminal

EV510 series inverter comes standard with two multi-function analog output terminals, one multi-function digital output terminal, two multi-function relay output terminals, one HDO terminal (can be selected as high-speed pulse output terminal, Open-circuit switch output)

P5-00	HDO Terminal output mode selection		Factory default	0
	Set range	0 : Pulse output (HDP) 1 : Switch output (HDY)		

The HDO terminal is a programmable multiplex terminal that can be used as a high-speed pulse output terminal or as a switch output terminal with open collector.

When the pulse is output, the maximum frequency of the output pulse is 100 kHz. Refer to P5-06 for the related function.

P5-01	HDY Output function selection (Open collector output terminal)	Factory default	0
P5-02	relay1 Output function selection (RO1A-	Factory default	2

The function of the multi-function output terminal is described below :

Set value	Function	description
0	Non-output	The output terminal has no function
1	The inverter is running	Indicates that the inverter is running and has an output frequency (which may be zero). At this time, the ON signal is output.
2	Error output(error	When the inverter fails and the fault is stopped, the ON signal is output.

Set value	Function	description
	stop)	
3	Frequency level detection FDT1 output	Please refer to the description of function codes P8-19 and P8-20.
4	Frequency reached	Please refer to the description of function codes P8-19 and P8-20.
5	Zero speed operation (non output when stop work)	When the inverter is running and the output frequency is 0, the ON signal is output. This signal is OFF when the drive is in the stop state.
6	Motor overload warning	Before the motor overload protection operation is performed, it is judged based on the threshold value of the overload pre-alarm, and the ON signal is output after the pre-alarm threshold is exceeded. Refer to function code P9-00 ~ P9-02 for motor overload parameter setting.
7	AC drive overload warning	10 seconds before the inverter overload protection occurs, the ON signal is output.
8	Set number reached	When the count value reaches the value set by PB-08, the ON signal is output.
9	Specifies that the count value arrives	When the count value reaches the value set by PB-09, the ON signal is output. The counting function refers to the PB group function description
10	Length reached	When the actual length of the detection exceeds the length set by PB-05, the ON signal is output.
11	PLC cycle finished	When the simple PLC run to complete a cycle, the output of a width of 250ms pulse signal.
12	The cumulative run time arrives	When the accumulated running time of the inverter exceeds the set time of P8-17, the ON signal is output.
13	Frequency limit	When the set frequency exceeds the upper limit frequency or lower limit frequency, and the inverter output frequency also reached the upper limit frequency or lower limit frequency, the output ON signal.
14	Torque limit	In the speed control mode, when the output torque reaches the torque limit value, the inverter is in the stall protection state and outputs the ON signal at the same time.
15	Ready to run	When the inverter main circuit and the control circuit power supply has been stable, and the inverter does not detect any fault information, the inverter is in the running state, the output ON signal.
16	AI1>AI2	When the analog input AI1 value is greater than the AI2 input value, the output ON signal.
17	Upper limit frequency arrival	When the operating frequency reaches the upper limit frequency, the ON signal is output.

Set value	Function	description
18	Lower frequency arrival (Not output when stopped)	When the operating frequency reaches the lower limit frequency, the ON signal is output. In shutdown mode, the signal is OFF.
19	Under voltage status output	When the inverter is in the undervoltage condition, the ON signal is output.
20	Communication settings	Please refer to the communication protocol.
21	Keep	keep
22	keep	keep
23	Zero speed running 2 (Also output when stopped)	When the inverter output frequency is 0, the ON signal is output. The signal is also on in the shutdown state
24	The accumulated power-up time arrives	When the accumulated time (P7-13) of the inverter exceeds the set time of P8-16, the ON signal is output.
25	Frequency level detection FDT2 output	Please refer to the description of function codes P8-28 and P8-29.
26	Frequency 1 reaches the output	Please refer to the description of function codes P8-30 and P8-31.
27	Frequency 2 reaches the output	Please refer to the description of function codes P8-32 and P8-33.
28	Current 1 reaches the output	Please refer to the description of function codes P8-38 and P8-39.
29	Current 2 reaches the output	Please refer to the description of function codes P8-40 and P8-41.
30	Timed arrival output	When the timer function selection (P8-42) is valid, the inverter will output the ON signal after the running time reaches the set time.

31	AI1 enter the limit	When the value of analog input AI1 is greater than P8-46 (AI1 input protection upper limit) or less than P8-45 (AI1 input protection lower limit), the ON signal is output.
32	Under load	When the inverter is in the under load state, the ON signal is output.
33	Reverse run	When the inverter is running in reverse operation, the ON signal is output
34	Zero current state	Please refer to the description of function codes P8-28 and P8-29
35	Module temperature arrives	The inverter module radiator temperature (P7-07) reaches the set module temperature When the arrival value (P8-47) is reached, the ON signal is output
36	Software current limit	Please refer to the description of function codes P8-36 and P8-37

37	Lower frequency arrival (Shutdown also output)	When the operating frequency reaches the lower limit frequency, the ON signal is output. The signal is also ON in the shutdown state
38	Warning output	When the inverter fails, and the fault processing mode for the continued operation, the inverter alarm output.
39	Motor over temperature alarm	When the motor temperature reaches P9-58 (motor overheat pre-alarm threshold), the ON signal is output. (Motor temperature can be viewed by d0-34)
40	The run time arrives	When the inverter starts running for more than the time set by P8-53, the ON signal is output.
41	Fault output	Fault output (for freewheel failure and undervoltage is not output)

P5-06	HDP Output function selection (Pulse output terminal)	Factory default	0
P5-07	AO1 Output function selection	Factory default	0

HDP terminal output pulse frequency range of 0.01 KHz ~ P5-09 (HDO output maximum frequency), P5-09 can be set between 0.01 kHz ~ 100.00 kHz.

Analog output AO1 and AO2 output range of 0V ~ 10V, or 0mA ~ 20mA.

Pulse output or analog output range, and the corresponding function of the scaling relationship as shown in the following table:

Set value	Function	Pulse or analog output 0.0% to 100.0% of the corresponding function
0	Working frequency	0 ~ max output frequency
1	Set frequency	0 ~ max output frequency
2	Output current	0 ~ 2 times motor rated current
3	Output torque (Absolute value)	0 ~ 2 times rated Output torque
4	Output power	0 ~ 2 times rated power
5	Output voltage	0 ~ 1.2times AC drive output voltage
6	High speed pulse input	0.01kHz ~ 100.00kHz
7	AI1	0V ~ 10V
8	AI2	0V ~ 10V (or 0 ~ 20mA)
9	AI3	0V ~ 10V
10	Length	0 ~ max set length
11	Number setting	0 ~ max number
12	Communication	0.0% ~ 100.0%

Set value	Function	Pulse or analog output 0.0% to 100.0% of the corresponding function settings
13	Motor speed	0 ~ The maximum output frequency corresponds to the speed
14	Output current	0.0A~1000.0A
15	output voltage	0.0V~1000.0V
16	Output torque (actual value)	-2 times the motor rated torque~2 times the motor rated torque

P5-09	HDP output max	Factory default	50.00kHz
	Set range	0.01kHz ~ 100.00kHz	

When the HDO terminal is selected as a pulse output, the function code is used to select the maximum frequency value of the output pulse.

P5-10	AO1 Zero partial	Factory default	0.0%
	Set range	-100.0% ~ +100.0%	
P5-11	AO1 profits	Factory default	1.00
	Set range	-10.00 ~ +10.00	

The above function codes are generally used to correct the zero drift of the analog output and the deviation of the output amplitude. It can also be used to customize the desired AO output curve.

If the zero is denoted by "b", the gain is denoted by k, the actual output is denoted by Y, and the standard output is denoted by X, then the actual output is: $Y = kX + b$.

Among them, AO1, AO2 zero partial coefficient of 100% corresponds to 10V (or 20mA), the standard output is no zero bias and gain correction, the output 0V ~ 10V (or 0mA ~ 20mA) corresponding to the amount of analog output.

For example, if the analog output content is the operating frequency, it is desirable to output 8V when the frequency is 0 and 3V when the frequency is the maximum frequency. The gain should be set to "-0.50" and the zero bias should be set to "80%".

P5-17	HDY output the delay time	Factory setting	0.0s
	Set range	0.0s ~ 3600.0s	
P5-18	Relay 1 outputs the delay time	Factory setting	0.0s
	Set range	0.0s ~ 3600.0s	

Set the output terminal HDY, relay 1, relay 2, from the state change to the actual output to produce changes in the delay time

P5-22	HDO Output terminal valid status selection	Factory default	00000
-------	--	-----------------	-------

	Set range	bits	HDY Effective state selection	
		0 : Positive logic		1 : Anti-logic
		tens	RO1A Valid status settings (0 ~ 1 , as	
		One	RO2A Valid status settings (0 ~ 1 , as	
		Thousands /	keep	

Defines the output logic of the output terminal HDO, relay 1, and relay 2.

0: Positive logic, digital output terminal and corresponding common terminal are connected to active state and are disconnected to invalid state;

1: Anti-logic, digital output terminal and the corresponding common terminal connected to an invalid state, open to a valid state.

P6 Group Start-Stop control

P6-00	Start running mode	Factory default	0
	Set range	0 : Direct start 1: Speed tracking restart 2:Pre-excitation start (AC induction motor) 3:SVC Quick Start	

➤ 0:direct start

If the DC braking time is set to 0, the drive will start from the start frequency.

If the DC braking time is not 0, the DC braking will start and then start from the starting frequency. For small inertia loads, the motor may have a rotating occasion at start-up.

➤ 1:speed tracking restart

The inverter first to determine the speed and direction of the motor, and then to track the motor frequency to start, the rotation of the motor to implement smooth and no impact start. For a large inertia load instantaneous power failure to restart. In order to ensure the performance of speed tracking and restart, it is necessary to set the parameters of motor P1 group accurately.

➤ 2: asynchronous machine pre-excitation start

It is only valid for asynchronous motors and is used to establish a magnetic field before the motor is running.

Pre-excitation current, pre-excitation time See function code P6-05, P6-06 Description.

If the pre-excitation time is set to 0, the inverter will cancel the pre-excitation process and start from the start frequency. Pre-excitation time is not 0, then the pre-excitation and then restart, can improve the motor dynamic response performance.

If the DC braking time is set to 0, the drive will start from the start frequency.

If the DC braking time is not 0, the DC braking will start and then start from the starting frequency. For small inertia loads, the motor may have a rotating occasion at start-up.

□

P6-03	Direct start frequency	Factory default	0.00Hz
	Set range	0.00Hz ~ 10.00Hz	

P6-04	Start frequency hold time	Factory default	0.0s
	Set range	0.0s ~ 100.0s	

To ensure the motor torque at start-up, set the appropriate starting frequency. In order to fully establish the magnetic flux when starting the motor, it is necessary to start the frequency for a certain time. The start frequency P6-03 is not limited by the lower limit frequency. But the set target frequency is less than the starting frequency, the inverter does not start, in standby mode.

During the forward / reverse switching, the start frequency hold time does not work.

The start frequency hold time is not included in the acceleration time but is included in the operation time of the simple PLC.

P6-05	DC braking current / pre-excitation current before starting	Factory default	50%
	Set range	0% ~ 100%	
P6-06	DC braking time before start / pre-excitation time	Factory default	0.0s
	Set range	0.0s ~ 100.0s	

Start the DC brake, generally used to stop the operation of the motor and then start. Pre-excitation for the first induction motor to establish a magnetic field and then start to improve the response speed.

The start of the DC brake is valid only when the start mode is a direct start. At this point the inverter first set the DC braking current to start the DC braking, after starting the DC braking time and then start running. If the DC braking time is set to 0, it will not start directly without DC braking. The greater the DC braking current, the greater the braking force.

If the starting mode is pre-excitation start of the asynchronous machine, the inverter will set the magnetic field in advance according to the set pre-excitation current, and then start the operation after the set pre-excitation time. If the pre-excitation time is set to 0, it is not directly pre-energized.

Starting the DC braking current / pre-excitation current is the percentage of the rated current relative to the inverter.

P6-07	Acceleration and deceleration mode selection	Factory default	0
	Set range	0: linear acceleration/deceleration 1 : S curve acceleration / deceleration A (static) 2 : S curve acceleration/deceleration B (dynamic)	

- 0 : linear acceleration and deceleration

The output frequency is incremented or decremented by line.

- 1 : S curve acceleration and deceleration A (static)

The output frequency is incremented or decremented according to the S curve. The S-curve is used in places where gentle start or stop is required, such as elevators, conveyor belts, etc.

- 2 : S curve acceleration and deceleration B (dynamic)

Generally used for high-speed areas above the rated frequency of the need for rapid acceleration and deceleration occasions.

P6-08	S Curve start time ratio	Default value	30.0%
	Set range	0.0% ~ (100.0%-P6-09)	
P6-09	S Curve start time ratio	Default value	30.0%
	Set range	0.0% ~ (100.0%-P6-08)	

Function codes P6-08 and P6-09 respectively define the start and end time ratios of the S curve acceleration and deceleration A, and the two function codes are satisfied: $P6-08 + P6-09 \leq 100.0\%$.

P6-10	Stop way choose	Factory value	0
	Set range	0 : Decelerate to Stop 1 : Coast to Stop	

- 0 : Decelerate to Stop

Once the stop command is input, the AC drive decreases the output frequency based on the deceleration time to 0 and stop.

- 1 : Coast to Stop

Once the stop command is input, the AC drive immediately stops output. The motor then Coasts to stop based on the mechanical inertia.

P6-11	DC braking to stop start frequency	Factory default	0.00Hz
	Setting Range	0.00Hz ~ Max frequency	
P6-12	DC braking to stop delay time	Factory default	0.0s
	Setting Range	0.0s ~ 36.0s	
P6-13	DC braking to stop current	Factory default	50%
	Setting Range	0% ~ 100%	
P6-14	DC braking to stop time	Factory default	0.0s

Setting Range	0.0s ~ 36.0s
---------------	--------------

DC braking to stop start frequency: The inverter starts DC braking stop when the running frequency decreases to the value set in this parameter in the process of deceleration to stop.

DC braking to stop delay time: When the running frequency decreases to DC braking to stop start frequency in P6-11, the inverter stops output for a period of time and then starts DC injection braking. This prevents the occurrence of fault such as over current caused by direct DC injection braking at high speed.

DC braking to stop time: it is the output current of DC braking and relative to the percentage of motor rated current. The greater the value, the greater the DC braking effect, but the greater the heating of the motor and inverter.

DC braking to stop time: DC brake hold time. If this value is 0, the DC braking process is canceled.

The DC braking process is shown in Figure 6-13.

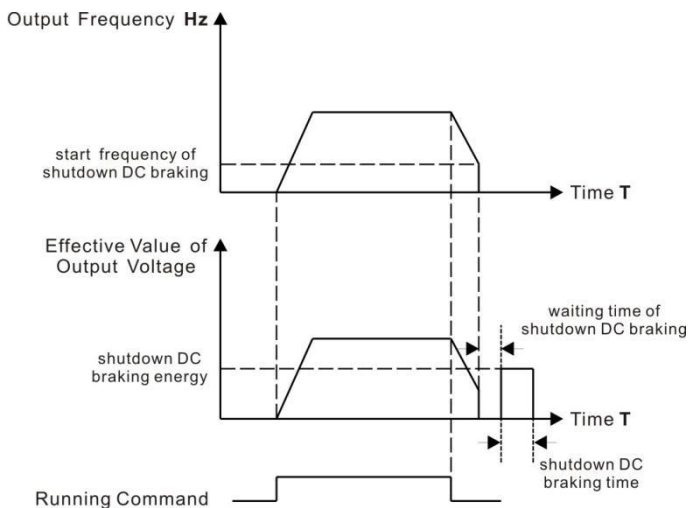
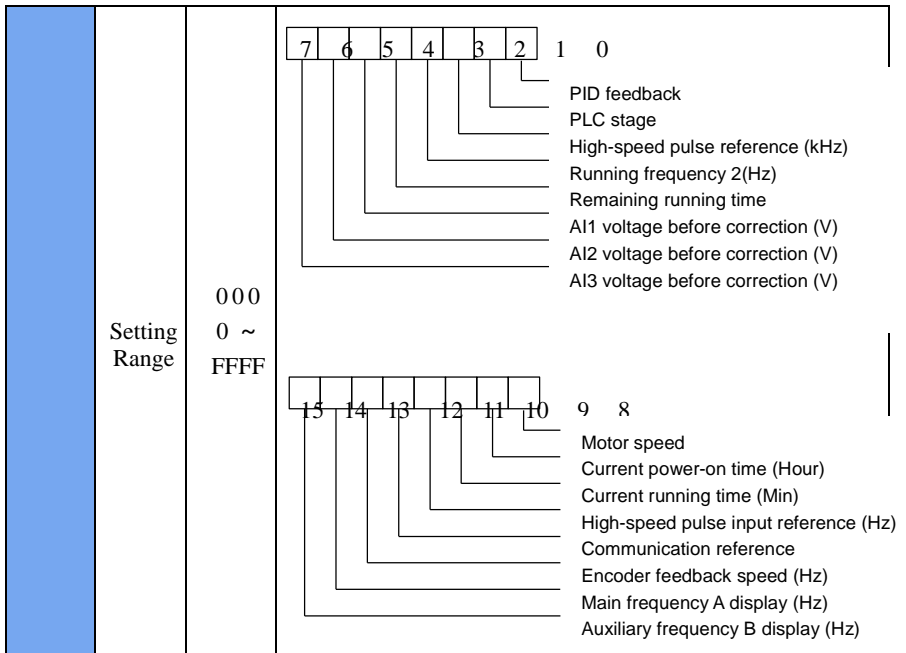

Figure 6-13 DC braking process

P7 Group Keypad and display

P7-03	LED display running parameters 1 running parameters 1	Factory default	1F
-------	--	--------------------	----

P7-04	LED display running	Factory	0
	Setting Range	<p>000 0 ~ FFFF</p> <p>15 14 13 12 11 10</p> <p>If a parameter needs to be displayed during running, set corresponding bit to 1, and set P7-03 to hexadecimal equivalent.</p>	



If a parameter needs to be displayed during running, set Corresponding bit to 1, and set F7-04 to hexadecimal equivalent.

For display running parameters, it set which display parameters to view during running. The most available state parameters are 32, according to the values of P7-03 and P7-04, to select the state parameters that need to be displayed, and the display order begins at the lowest bit of P7-03.

P7-05	LED display stop parameters	Factory	0
-------	-----------------------------	---------	---

P8 Group Auxiliary Function

P8-00	Jog frequency reference		Factory default	6.00Hz
	Setting Range	0.00Hz ~ Maximum frequency		
P8-01	Jog acceleration time		Factory default	20.0s
	Setting Range	0.0s ~ 6500.0s		
P8-02	Jog deceleration time		Factory default	20.0s

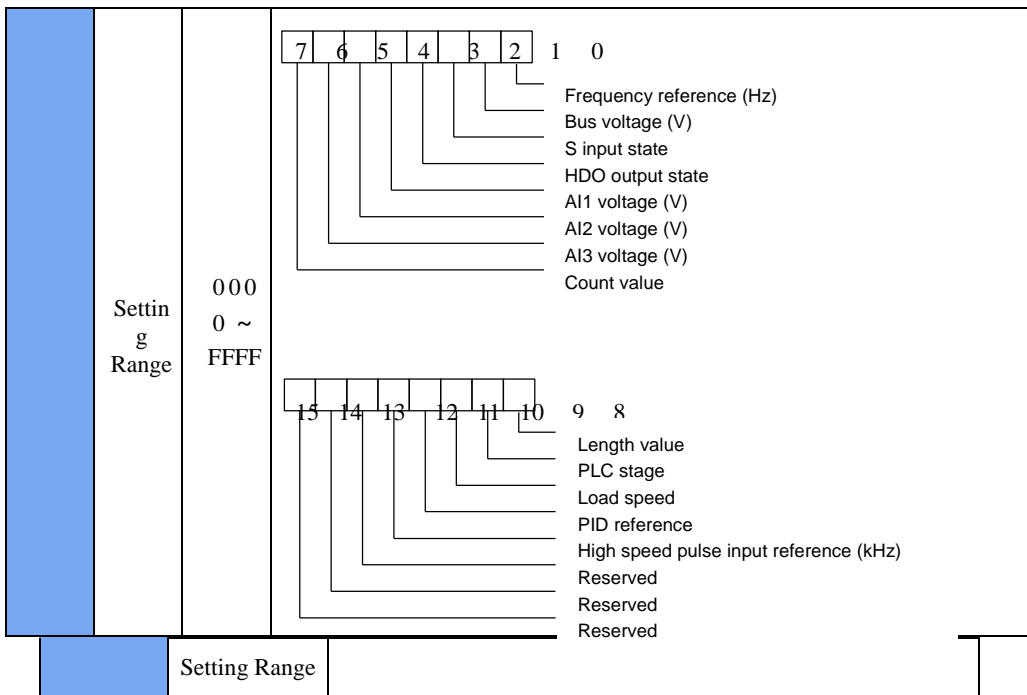

This function parameter defines frequency reference and acceleration/deceleration time during Jog running.

During Jog running, P6-00 must be set to 0 (direct start) and F6-10 must be set to 0 (Decelerate to stop).

	Acceleration time 2	Factory default	20.0s
P8-03	Setting Range	0.0s ~ 6500.0s	
	Deceleration time 2	Factory default	20.0s
P8-04	Setting Range	0.0s ~ 6500.0s	
	Acceleration time 3	Factory default	20.0s
P8-05	Setting Range	0.0s ~ 6500.0s	
	Deceleration time 3	Factory default	20.0s
P8-06	Setting Range	0.0s ~ 6500.0s	
	Acceleration time 4	Factory default	20.0s
P8-07	Setting Range	0.0s ~ 6500.0s	
	Deceleration time 4	Factory default	20.0s

	Setting Range	0.0s ~ 6500.0s
--	---------------	----------------

DSI-200 provides totally four groups of acceleration/deceleration time for selection (P0-17、P0-18 and the above three groups of acceleration/deceleration time).

These four groups of acceleration/deceleration time define are same, please reference P0-17、P0-18 of instruction.

By using the different combination of multi-function digital input terminal S, we can switch over the selection of 4 groups four groups of acceleration/deceleration time.

Please refer to the relevant instructions in function code P4-01 ~ P4-05.

P8-09	Frequency jump 1	Factory default	0.00Hz
	Setting Range	0.00Hz ~ Maximum frequency	
P8-10	Frequency jump 2	Factory default	0.00Hz
	Setting Range	0.00 Hz ~ Maximum frequency	
P8-11	Frequency jump band	Factory default	0.00Hz
	Setting Range	0.00 ~ Maximum frequency	

When the frequency is set in the range of the frequency jump, the actual running frequency will run at the frequency jump point of the setting frequency nearby. By setting frequency jump, the inverter can avoid the mechanical resonance of the load. DSI-200 can be set with two separate frequency jump point. If both are set to 0, the frequency jump function is disabled. For the principle of jump frequency and jump frequency range, please refer to figure 6-14.

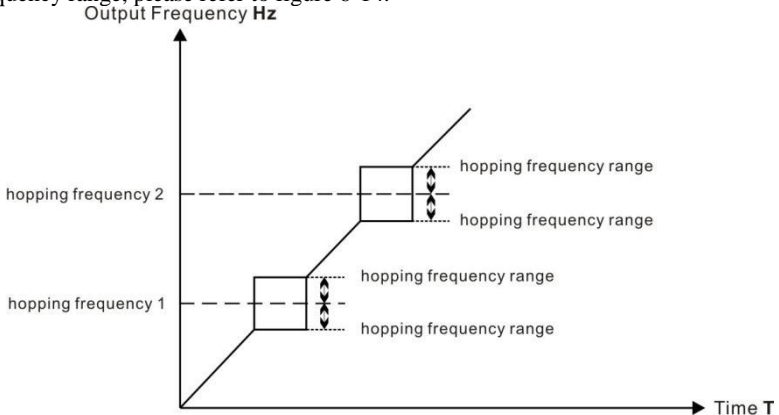

Figure 6-14 Frequency jump principle

P8-12	Forward/Reverse run Switch over dead-zone time	Factory default	0.0s
-------	--	-----------------	------

	Setting Range	0.00s ~ 3000.0s
--	---------------	-----------------

In the process of setting the inverter forward and reverse, the switchover time in the output 0Hz is shown in figure 6-15.

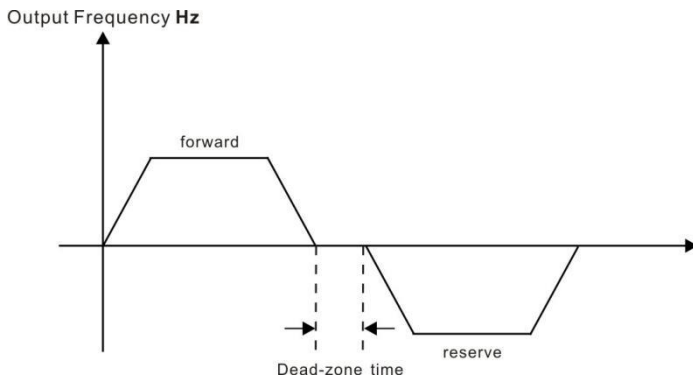

Figure 6-15 Forward/Reverse run switch over dead-zone time

P8-13	Forbid reverse run selection	Factory default	0
	Setting Range	0 : Enabled 1 : Disabled	

This parameter sets whether the inverter is allowed to run in reverse mode, and P8-13 = 1 is set in the case where the motor is not allowed to reverse.

P8-14	Running mode when frequency reference lower than frequency lower limit	Factory default	0
	Setting Range	0 : Run at frequency reference lower limit 1 : Stop 2 : Run at zero speed	

When the frequency reference is lower than the frequency lower limit, the operating state of the inverter can be selected by this parameter. DSI-200 provides three operating modes to meet various application requirements.

P8-15	Droop rate	Factory default	0.00%
	Setting Range	0.00 ~ 10.00%	

This function is typically used for load distribution when multiple motor drag the same load.

For droop control, as the load increases, the inverter output frequency drops. so many motors drive the same load, the motor with more heavy load of output frequency drop more, thus can reduce the load of the motor, realize the motor load evenly.

This parameter refers to the frequency drop output value when the rated load is output.

P8-16	Accumulative power-on time threshold	Factory default	0h
	Setting Range	0h ~ 65000h	

Multi-function digital terminal HDO output ON signal when accumulative power-on time of the AC drive (P7-13) exceeds value set in FP-16.

Set the cumulative time to reach 100 hours: P8-16 = 100.

Then, when the accumulated power time reaches 100 hours, the inverter output faulty of FU29.

P8-17	Accumulative running time threshold	Factory default	0h
	Setting Range	0h ~ 65000h	

This parameter is used to set up the running time of the inverter.

When the cumulative running time (P7-09) arrives at the set running time, the multi-function digital terminal HDO output ON signal.

P8-18	Start-up terminal protection	Factory default	0
	Setting Range	0 : no protection	1 : protection

This parameter relates to the safety protection of the frequency inverter.

If the parameter is set to 1, if the inverter is powered on and run command is valid (such as terminal with the run command close before electricity), the frequency inverter does not respond to run command, you must firstly remove run command one time, after run command is valid again, frequency inverter will response run command.

In addition, if the parameter is set to 1, if the frequency inverter fault reset and run command is valid, the frequency inverter also does not respond run command, you must firstly remove run command to avoid running protection state.

Setting this parameter to 1 can prevent the motor from responding run command and becoming dangerous in the event of electrifying or failure reset when do not know all situation.

P8-19	Frequency detection value FDT1	Factory default	50.00Hz
	Setting Range	0.00Hz ~ max. frequency	
P8-20	Frequency detection hysteresis FGT1	Factory default	5.0%
	Setting Range	0.0% ~ 100.0% (FDT1 level)	

When running frequency exceeds the detection value, the multi-function digital terminal HDO output ON signal.

When the running frequency is lower than the detection value, HDO output OFF signal.

The above parameters are used to set the detection value of the output frequency and the lag value of the output action end. P8-20 is the percentage of the lag frequency relative to the frequency detection value P8-19. Figure 6-16 show FDT function.

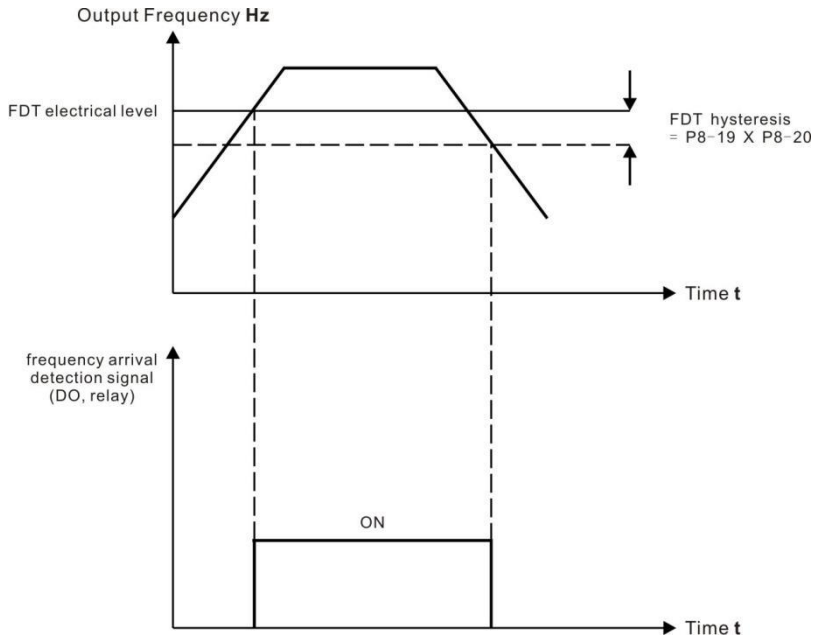

Figure 6-16 FDT electrical level function

P8-21	Detection width of target frequency reached	Factory default	0.0%
	Setting Range	0.00 ~ 100%max. frequency	

When the run frequency of the inverter is in a certain range of the target frequency, multi-function terminal HDY outputs the ON signal.

This parameter is used to set the detection range of the frequency arrival, which is the percentage relative to the maximum frequency. Figure 6-17 is a schematic diagram of frequency arrival.

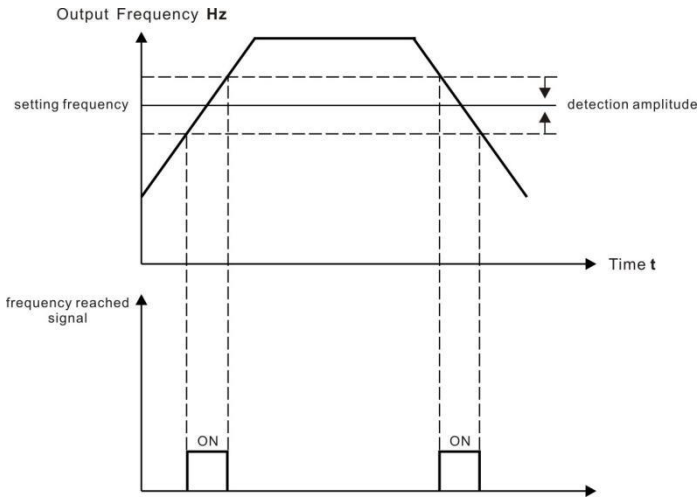

Figure 6-17 schematic diagram of frequency arrival detection

P8-22	Frequency jump function valid during acceleration/deceleration	Factory default	0
	Setting Range	0 : invalid	1 : valid

The function code is used to set whether the frequency jump is valid during acceleration and deceleration.

If set to be valid, when the running frequency is in the frequency jump range, the actual running frequency will jump over frequency jump boundary. Figure. 6-18 is a schematic diagram of frequency jump valid during acceleration and deceleration.

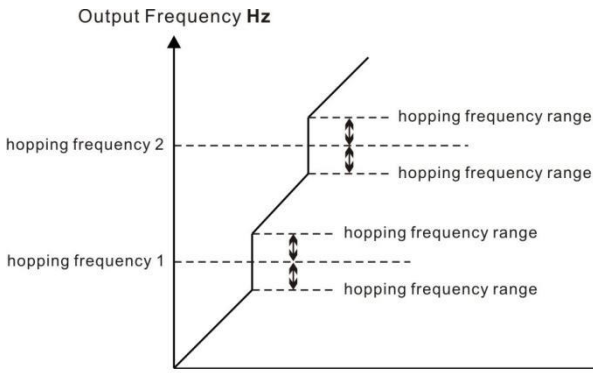

Figure. 6-18 schematic diagram of frequency jump valid during acceleration and deceleration.

P8-25	Switch over frequency of acceleration time 1 and acceleration time 2	Factory default	0.00Hz
	Setting Range	0.00Hz ~ max. frequency	
P8-26	Switch over frequency of deceleration time 1 and deceleration time 2	Factory default	0.00Hz
	Setting Range	0.00Hz ~ max. frequency	

This function is valid when the motor is selected as motor 1 and is not switched over through the S terminal to select the acceleration and deceleration time. During the frequency inverter running process, not through the S terminal, but in accordance with the frequency run range, choose different acceleration and deceleration.

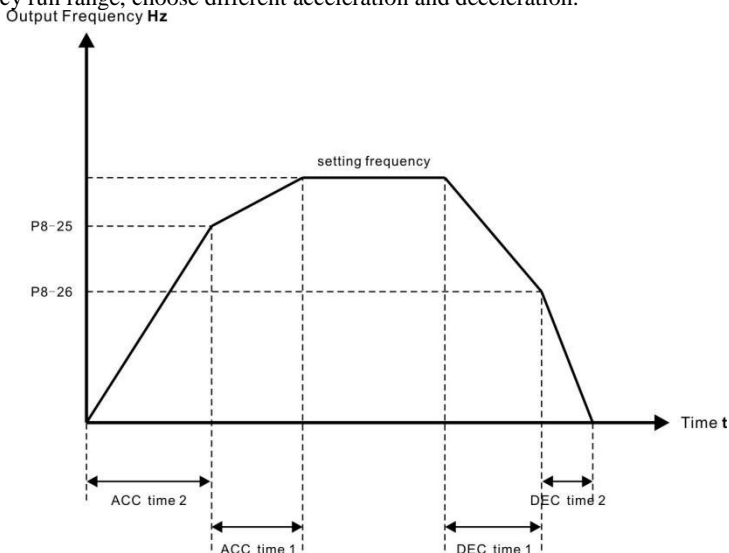

Figure 6-19 Acceleration/Deceleration time switch over

During acceleration, if the running frequency is below P8-25, acceleration time 2 is selected. If it is above P8-25, acceleration time 1 is selected.

During deceleration, if the running frequency is above P8-26, deceleration time 1 is selected. If it is below P8-26, deceleration time 2 is selected.

P8-27	Set highest priority to terminal JOG function	Factory default	0
	Setting Range	0 : invalid	1 : valid

This parameter is used to set whether the terminal JOG function has the highest priority. When the terminal JOG function is given priority, if the terminal JOG occurs during running, the frequency inverter is switched to the terminal JOG status.

P8-28	Frequency detection value 2 (FDT2)	Factory default	50.00Hz
	Setting Range	0.00Hz ~ max. frequency	
P8-29	Frequency detection hysteresis 2	Factory default	5.0%
	Setting Range	0.0% ~ 100.0% (FDT2 electric level)	

The frequency detection function is exactly the same as the function of FDT1. Please refer to the relevant instructions of FDT1 with the function code P8-19 and P8-20.

P8-30	Detection of frequency 1	Factory	50.00Hz
	Setting Range	0.00Hz ~ max. frequency	
P8-31	Detection width of frequency 1	Factory default	0.0%
	Setting Range	0.0% ~ 100.0% (max. frequency)	
P8-32	Detection of frequency 2	Factory default	50.00Hz
	Setting Range	0.00Hz ~ max. frequency	
P8-33	Detection width of frequency 2	Factory default	0.0%
	Setting Range	0.0% ~ 100.0% (max. frequency)	

When the output frequency of the inverter is within positive and negative detection range of frequency detection value, the multi-functional terminal DO outputs the ON signal. DSI-200 provides two sets of random arrival frequency detection parameters, respectively setting frequency value and frequency detection range. Figure 6-20 is a schematic diagram of the detection of frequency function.

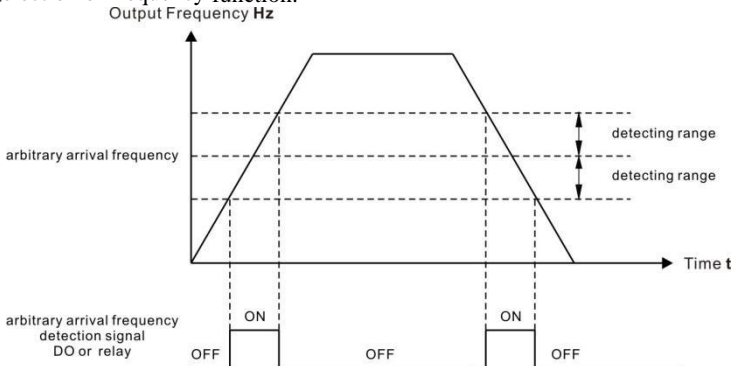

Figure 6-20 Delection of frequency arrive function.

P8-34	Zero current detection level	Factory default	5.0%
	Setting Range	0.0% ~ 300.0% (rated motor current)	
P8-35	Zero current detection delay	Factory default	0.10s
	Setting Range	0.00s ~ 600.00s	

When the output current of the inverter is less than or equal to the detection level of the zero current and the delay time exceeds the zero current detection delay time, the multi-function terminal HDY outputs the ON signal. Figure 6-21 is a schematic diagram of zero current detection.

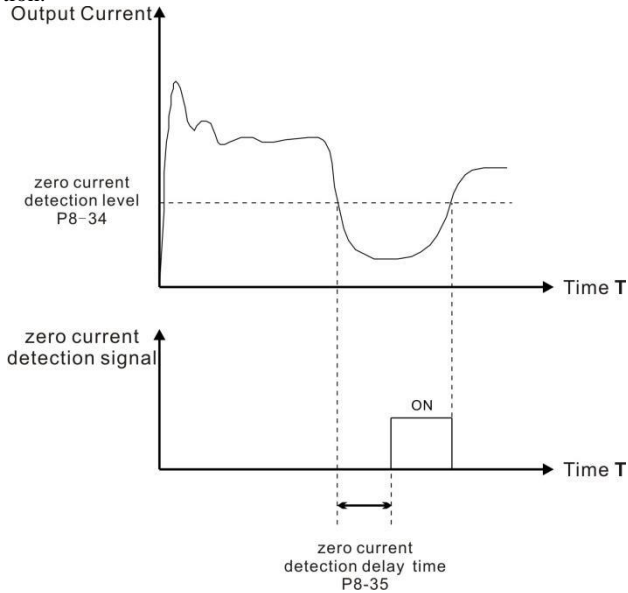

Figure 6-21 Zero current detection.

P8-36	Output over current threshold	Factory default	200.0%
	Setting Range	0.0% (no detection) ; 0.1% ~ 300.0% (rated motor current)	
P8-37	Output over current detection delay	Factory default	0.00s
	Setting Range	0.00s ~ 600.00s	

If the inverter output current is equal to or more than the value set in P8-36 and the delay time exceeds the value set in P8-37, multi-function terminal HDY output on signal. Figure 6-22 Output current limit.

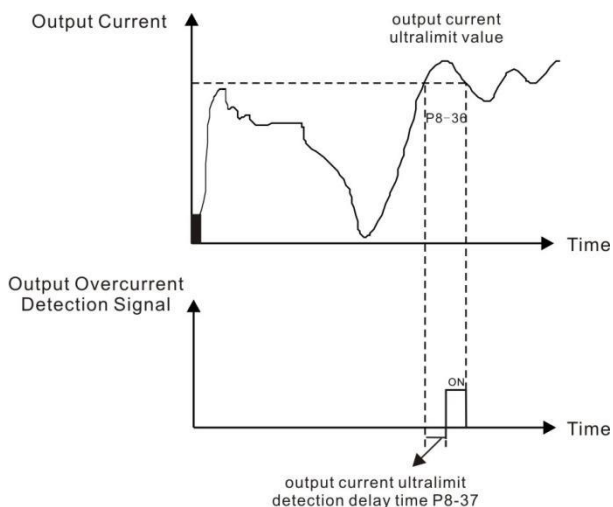

Figure 6-22 Output current limit.

P8-38	Detection level of current 1	Factory default	100.0%
	Setting	0.0% ~ 300.0% (rated motor current)	
P8-39	Detection width of current 1	Factory default	0.0%
	Setting	0.0% ~ 300.0% (rated motor current)	
P8-40	Detection level of current 2	Factory default	100.0%
	Setting	0.0% ~ 300.0% (rated motor current)	
P8-41	Detection width of current 2	Factory default	0.0%
	Setting	0.0% ~ 300.0% (rated motor current)	

When the output current of the inverter reach into the positive and negative detection width, the multi-function terminal HDO outputs the ON signal.

DSI-200 provides two sets of arrival current detection width parameters. Figure 6-23 is functional schematic diagram.

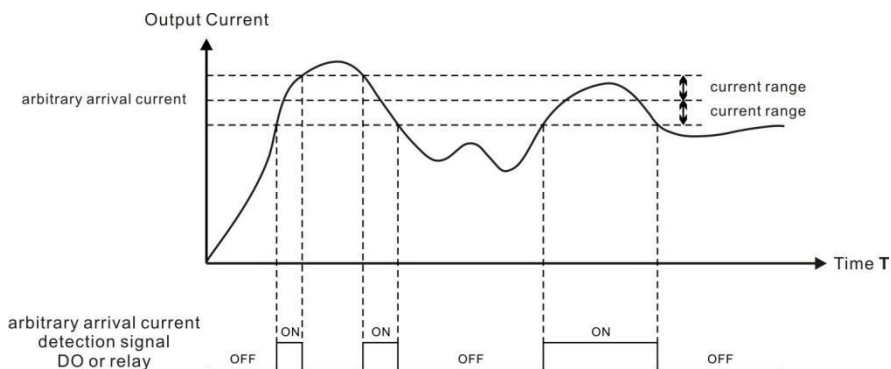

Figure 6-23 Current detection

P8-42	Timing function	Factory default	0
	Setting Range	0 : invalid 1 : valid	
P8-43	Running time setting channel	Factory default	0
	Setting Range	0 : set by P8-44 1 : AI1 2 : AI2 3 : AI3 (100% of analog input corresponds to the value of P8-44)	
P8-44	Running time	Factory default	0.0Min
	Setting Range	0.0Min ~ 6500.0Min	

This set of parameters is used to set the timing function of the inverter.

When the P8-42 timing function is selected, the frequency inverter starts the timing ,after reaching the set running time, the frequency inverter automatically stops, and the multi-function terminal HDY outputs the ON signal.

Each time the inverter starts, it starts clocking from 0, and the remaining running time can be checked by d0-20.

The run time is set by P8-43 and P8-44, and the time unit is minute

P8-45	AI1 input voltage lower limit	Factory default	3.10V
	Setting Range	0.00V ~ P8-46	
P8-46	AI1 input voltage upper limit	Factory default	6.80V
	Setting Range	P8-45 ~ 10.00V	

When the analog input AI1 is greater than P8-46, or the AI1 input is less than P8-45, the inverter multi-function terminal HDO outputs "AI1 input more than limitation" of ON signal, which is used to indicate whether the input voltage of the AI1 is within the set range.

P8-47	IGBT temperature threshold	Factory default	75°C
	Setting Range	0.00V ~ P8-46	

When the temperature of the inverter radiator reaches the temperature, the multi-function terminal HDO output "module temperature overheat" of ON signal.

P8-48	Cooling fan working mode	Factory default	0
	Setting Range	0 : Working during drive running continuously 1 : Working continuously	

The parameter sets cooling fan operation mode, when the value set to 0, inverter in the running state makes fan to work, When the drive stops, the fan works if heatsink temperature is above 40°C and stops if heatsink temperature is below 40°C.

When the value set to 1, the fan keeps working after power-on.

P8-49	Wake up frequency	Factory default	0.00Hz
	Setting Range	Hibernating frequency (P8-51) ~ max. frequency (P0-10)	
P8-50	Wake up delay time	Factory default	0.0s
	Setting Range	0.0s ~ 6500.0s	
P8-51	Hibernating frequency	Factory default	0.00Hz
	Setting Range	0.00Hz ~ wake up frequency (P8-49)	
P8-52	Hibernating delay time	Factory default	0.0s
	Setting Range	0.0s ~ 6500.0s	

The hibernating and wakeup function is used in water supply application.

During drive running, when frequency reference is equal to or smaller than P8-51, the Inverter enters hibernating state after delay set in P8-52.

In hibernating state a, if run command is valid, when frequency reference is equal to or larger than P8-49, the AC drive wakes up after delay set in P8-50.

Generally, set wakeup frequency equal to or higher than hibernating frequency. If they are set to 0, the function is disabled.

When frequency reference setting channel is PID reference, whether to perform PID operation in hibernating state is determined by PA-28, perform PID operation in stop state(PA-28 = 1).

Group P9:Fault and Protection

P9-00	Motor overload protection	Factory default	1
	Setting Range	0:Disabled 1 : Enabled	
P9-01	Motor overload protection gain	Factory default	1.00
	Setting Range	0.20 ~ 10.00	

P9-00 = 0:No motor overload protection, there may be the risk of overheating damage to the motor, it is recommended install a thermal relay between inverter output (U, V, W) and the motor.

P9-00 = 1: At this point, the inverter will judge whether the motor is overloaded according to the inverse time limit curve of the motor overload protection.

The inverse time limit curve of motor overload protection is: 220% * (P9-01) * motor rated

	Setting Range	0 : Current running frequency 1 : Frequency reference 2 : Frequency upper limit 3 : Frequency lower limit 4 : Backup frequency for abnormality	
P9-55	Backup frequency for	Factory default	100.0%
	Setting Range	0.0% ~ 100.0%(max. frequency)	

When a fault occurs during the inverter running and the method of handling is set to continue running, the frequency inverter displays A** and runs at the frequency determined by the P9-54.

When you select the backup frequency for abnormality, the value is the percentage relative to the maximum frequency by P9-55 determine.

P9-59	No stop function selection during instantaneous power dip	Factory default	0
	Setting Range	0 : Invalid 1 : Bus voltage constant control 2 : Decelerate to stop	
P9-60	Threshold voltage of instantaneous stop action suspend	Factory default	85.0%
	Setting Range	80.0% ~ 100.0% (380V type) 100% correspond to 540V	
P9-61	Judging time of bus voltage recovering from power dip	Factory default	0.50s
	Setting Range	0.00s ~ 100.00s	
P9-62	Threshold voltage of instantaneous power dip judging	Factory default	80.0%
	Setting Range	60.0% ~ 100.0% (standard bus voltage)	

This function ensures the system to run continuously at occurrence of momentary power loss or reduce.

The inverter compensates DC bus voltage reduction with real-time energy feedback by reducing output frequency, maintain the frequency inverter continue to run.

If P9-59=1, when the instantaneous power failure or the voltage suddenly reduces, the frequency inverter reduces speed, when the bus voltage returns to normal, the frequency inverter speeds up to the set frequency to run. The basis of judging bus voltage recovery is that the bus voltage is normal and the duration is longer than the P9-61 setting time.

If P9-59=2, when the instantaneous power failure or the voltage suddenly reduces, the frequency inverter slows down until stop.

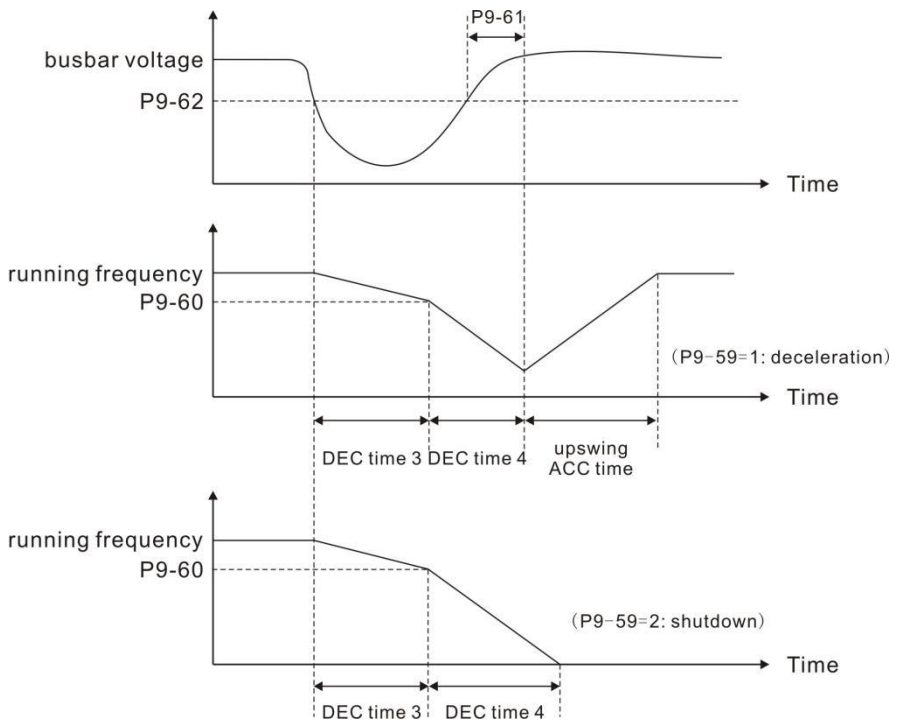

Figure 6-24 action during instantaneous power failure

P9-63	Load lost protection	Factory default	0
	Setting Range	0 : invalid	1 : valid
P9-64	Load lost detection level	Factory default	10.0%
	Setting Range	0.0% ~ 100.0% (Rated motor current)	
P9-65	Load lost detection time	Factory default	1.0s
	Setting Range	0.0s ~ 60.0s	

If load lost protection function is valid, when output current of the inverter falls below detection level (P9-64) for longer than time set in P9-65, the inverter responds load lost protection to act automatically (protection action is determined by P9-49, factory default is free stop). Once load recovers during protection, the inverter recover to frequency reference.

P9-67	Over speed detection level	Factory default	20.0%
	Setting Range	0.0% ~ 50.0%(max. frequency)	
P9-68	Over speed detection time	Factory default	1.0s (When is 10.0s, cancel muti-
	Setting Range	0.0s ~ 60.0s	

These function parameters define motor over speed detection that is effective only for

vector control with speed sensor.

When detected motor speed exceeds reference frequency and the excess is larger than the value of P9-67 for longer than time set in P9-68, the inverter warns FU43 and acts according to the faulty protection set.

If overspeed detection time is 0.0S, it will cancel over speed detection.

P9-69	Detection level of speed error	Factory default	20.0%
	Setting Range	0.0% ~ 50.0%(max. frequency)	
P9-70	Detection time of speed error	Factory default	5.0s
	Setting Range	0.0s ~ 60.0s	

This function is effective only for vector control with speed sensor.

When detected motor speed is different from frequency reference and the difference is larger than the value of P9-69 for longer than the time set in P9-70, the inverter warns FU43 and acts according to the faulty protection set.

If detection time of speed error is 0.0S,it will cancel detection of speed error.

P9-71	Gain Kp during no stop function with instantaneous power dip	Factory default	40
	Setting Range	0~100	
P9-72	Integral coefficient Ki during no stop function with instantaneous power dip	Factory default	30
	Setting Range	0~100	

This function is effective only for P9-59=1. During no stop function with instantaneous power dip, if it is under voltage, enlarge Kp and Ki.

P9-73	Deceleration time of power dip	Factory default	20.0s
	Setting Range	0~300.0s	

This function is effective only for P9-59=2 .

PA group Process control PID function

PID control is a common method of process control. By comparing the difference between the controlled feedback signal and the target signal, the output frequency of the inverter is adjusted to form the closed-loop system, and the controlled quantity is stabilized. Target value.

It is suitable for process control such as flow control, pressure control and temperature control. Figure 6-25 shows the control block diagram of process PID.

when PA-00=0

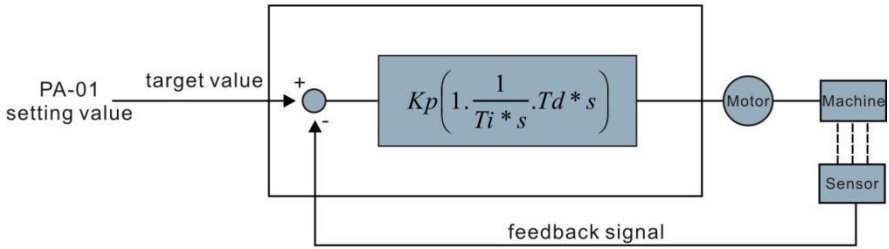

AI1, AI2, AI3, high speed pulse (S5), communication. . .

Figure 6-25 process PID schematic block diagram

PA-00	PID given source	Factory default	0
	Set range	0:PA-01 setting 1:AI1 2:AI2 3:AI3 4: high speed pulse input setting (S5) 5:Communication given 6: multi-segment instructions	
PA-01	PID given value	factory default	50.0%
	Set range	0.0% ~ 100.0%	

This parameter is used to select the target volume of the process PID.

The set value of the process PID is the relative value, and the setting range is 0.0% ~ 100.0%. The same PID feedback is the relative amount, the role of PID is to make the two relative amount of the same.

PA-02	PID feedback source	Factory default	0
	Set range	0 : AI1 1 : AI2 2 : AI3 3 : AI1 - AI2 4 : high speed pulse input setting (S5) 5 : Communication given 6 : AI1+AI2 7 : MAX (AI1 , AI2) 8 : MIN (AI1 , AI2)	

This parameter is used to select the feedback channel of the process PID.

The set value of the process PID is the relative value, and the setting range is 0.0% ~ 100.0%

PA-03	PID role direction	Factory default	0
	Set range	0 : Positive effect 1 : reaction	

Positive function: When the PID feedback signal is less than a given amount, the inverter output frequency increases. Such as the tension of the tension control occasions.

Reaction: When the PID feedback signal is less than a given amount, the inverter output frequency drops. Such as the tension of the tension control occasions. This function is affected by the direction of the multi-function terminal PID action (function 35), the need to pay attention.

PA-04	PID Given feedback range	Factory default	1000
	Set range	0 ~ 65535	

PID given feedback range is dimensionless units for PID reference display d0-15 and PID feedback display d0-16.

The relative value of the given feedback of the PID is 100.0%, corresponding to the given feedback range PA-04. For example, if the PA-40 is set to 2000, the PID reference display d0-15 is 2000 when the PID is set to 100.0%

PA-05	Proportional gain KP1	Factory default	20.0
	Set range	0.0 ~ 1000.0	
PA-06	Integration time Ti1	Factory default	2.00s
	Set range	0.01s ~ 10.00s	
PA-07	derivative time Td1	Factory default	0.000s
	Set range	0.00 ~ 10.000s	

➤ Proportional gain KP1 :

Determine the adjustment strength of the entire PID regulator, KP1 the greater the greater the intensity of regulation. The parameter 100.0 indicates that when the PID feedback amount and the deviation of the given quantity are 100.0%, the PID regulator adjusts the output frequency command to the maximum frequency

➤ Integration time Ti1 :

Determine the strength of the PID regulator integral adjustment. The shorter the integration time, the greater the adjustment intensity. The integral time is when the PID feedback and the given amount of deviation of 100.0%, the integral regulator through the time continuous adjustment, adjust the amount to reach the maximum frequency.

➤ Derivative time Td1 :

Determine the strength of the PID regulator to adjust the rate of change. The longer the differentiation time, the greater the intensity of regulation. The derivative time means that when the amount of feedback changes by 100.0% over that time, the adjustment of the differential regulator is the maximum frequency.

PA-08	PID Reverse cutoff frequency	Factory default	0.00Hz
	Set range	0 . 00 ~ Max frequency	

In some cases, it is possible for the PID to control the same amount of feedback to the same state only when the PID output frequency is negative (ie, the inverter is reversed), but the excessive inversion frequency is not allowed for some occasions , PA-08 is used to determine the reverse frequency upper limit.

PA-09	PID Deviation limit	Factory default	0.00%
-------	---------------------	-----------------	-------

	Set range	0.0% ~ 100.0%
--	-----------	---------------

When the deviation between the PID set amount and the feedback amount is less than PA-09, the PID stops the adjustment operation. In this way, the output frequency is stable when the deviation between the given feedback and the feedback is small, which is effective for some closed-loop control

PA-10	PID Differential limiting	Factory default	0.10%
	Set range	0.00% ~ 100.00%	

PID regulator, the role of differential is more sensitive, it is easy to cause the system oscillation, for which the PID differential is generally limited to a smaller range, PA-10 is used to set the PID differential output range.

PA-11	PID Given change time	Factory default	0.00s
	Set range	0.00s ~ 650.00s	

PID given change time, that PID set value from 0.0% to 100.0% of the time required. When the PID reference changes, the PID setpoint changes linearly according to the given change time, reducing the adverse effect of a given mutation on the system.

PA-12	PID Feedback filter time	Factory default	0.00s
	Set range	0.00s ~ 60.00s	
PA-13	PID Output filter time	Factory default	0.00s
	Set range	0.00s ~ 60.00s	

PA-12 is used to filter the PID feedback, which helps to reduce the effect of the amount of feedback on the feedback, but will bring the response performance of the closed-loop system.

PA-13 is used to filter the frequency of the PID output, which will reduce the frequency of the inverter output frequency, but also will bring the response performance of the closed-loop system.

PA-15	Proportional gain KP2	Factory default	20.0
	Set range	0.0 ~ 100.0	
PA-16	Integration time Ti2	Factory default	2.00s
	Set range	0.01s ~ 10.00s	
PA-17	Differential time Td2	Factory default	0.000s
	Set range	0.00 ~ 10.000	
PA-18	PID Parameter switching condition	Factory default	0
	Set range	0: Do not switch 1: Switch through S terminal 2:Automatic switching according to the deviation 3:Automatic switching according to the running frequency	

PA-19	PID Parameter switching deviation 1	Factory default	20.0%
	Set range	0.0% ~ PA-20	
PA-20	PID Parameter switching deviation 2	Factory default	80.0%
	Set range	PA-19 ~ 100.0%	

In some applications, a set of PID parameters cannot meet the needs of the entire operation process, the need for different conditions using different PID parameters.

This set of function codes is used for two sets of PID parameters. The regulator parameters PA-15 ~ PA-17 settings, and the parameters PA-05 ~ PA-07 similar.

Two sets of PID parameters can be switched through the multi-function digital S terminal, or it can be switched automatically according to the deviation of the PID.

(PA-05 to PA-07) is selected when the terminal is inactive, the parameter group is selected when the terminal is valid, when the multi-function terminal function selection is to be set to 43 (PID parameter switching terminal) 2 (PA-15 to PA-17).

When the absolute value between the reference and feedback is less than the PID parameter switching deviation 1 PA-19, the PID parameter selects the parameter group 1 when the automatic switching is selected. When the absolute value of the deviation between the reference and the feedback is greater than the PID switching deviation 2 PA-20, the PID parameter selection selects the parameter group 2. When the deviation between the reference and the feedback is between the switching deviation 1 and the switching deviation 2, the PID parameter is the linear interpolation value of the two sets of PID parameters, as shown in Figure 6-26.

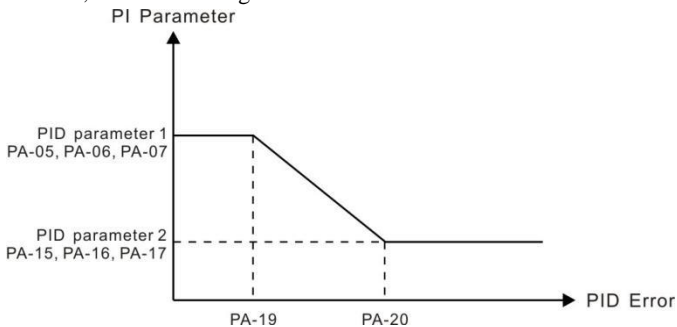

Figure 6-26 PID data parameter switching

PA-21	PID initial value	Factory default	0.0%
	Set range	0.0% ~ 100.0%	
PA-22	PID Initial value hold time	Factory default	0.00s
	Set range	0.00s ~ 650.00s	

When the inverter starts, the PID output is fixed to the PID initial value PA-21, and the PID continues to be closed-loop when the PID is maintained at the initial value of PA-22.

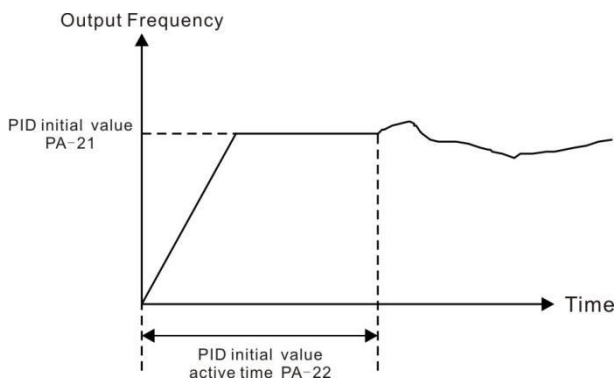

Figure 6-27 shows the function of the PID initial value

PA-25	PID Integral attribute	Factory default	00	
	Set range	Bit	Integral separation	
		0 : invalid		1 : valid
		Ten	Whether to stop the integration after outputting the limit value	
		0 : Continue to score		1 : stop to score

Integral separation

If the integral separation is valid, when the multi-function digital S integral is suspended (function 22) is valid, the integral PID integral of the PID stops operation, and PID is only proportional and differential.

When the integral separation selection is invalid, the integral separation is invalid regardless of whether the multi-function digital S is valid or not.

Whether to stop the points after outputting the limit:

After the PID operation output reaches the maximum or minimum value, you can choose whether to stop the integration effect. If the stop is selected, the PID integral stops counting at this time, which may help to reduce the overshoot of the PID.

PA-26	PID Feedback loss detection value	Factory default	0.0%
	Set range	0.0% : Do not judge feedback loss 0.1% ~ 100.0%	
PA-27	PID Feedback loss test value	Factory default	0.0s
	Set range	0.0s ~ 20.0s	

This function code is used to determine if PID feedback is lost.

When the PID feedback is less than the feedback loss detection value PA-26 and the duration exceeds the PID feedback loss detection time PA-27, the inverter alarm fault FU31 is processed and processed according to the selected fault handling method.

PA-28	PID Stop operation		Factory default	0
	Set range	0	Stop non-operation	
		1	Stop operation	

PB Group Wobble, length and count

Wobble function suitable for textile, chemical fiber and other industries, as well as the need for traverse, winding function of the occasion.

Wobble function refers to the inverter output frequency, set the frequency as the center of the upper and lower swing, the operating frequency in the time axis of the track as shown in Figure 6-28, the swing amplitude is set by PB-00 and PB-01. When PB-01 is set to 0, the swing is 0, and the wobble does not work.

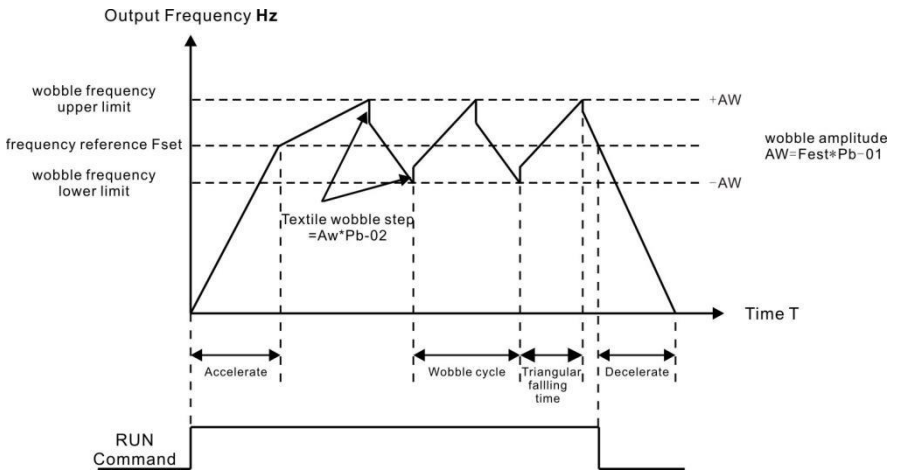

Figure 6-28 Wobble work diagram

PB-00	Swing setting mode	Factory default	0
	Set range	0: relative to center frequency 1: relative to maximum frequency	

Use this parameter to determine the reference for the swing.

- 0: relative center frequency (P0-07 frequency source), for the variable swing system. The swing varies with the center frequency (set frequency).
- 1: relative maximum frequency (P0-10), for the fixed swing system, swing fixed.

PB-01	Wobble amplitude	Factory default	0.0%
	Set range	0.0% ~ 100.0%	
PB-02	Sudden jump frequency	Factory default	0.0%
	Set range	0.0% ~ 50.0%	

Use this parameter to determine the value of the swing value and the sudden jumper frequency.

When setting the swing relative to the center frequency (PB-00 = 0), the swing AW = frequency source P0-07 × swing amplitude PB-01. When setting the swing relative to the maximum frequency (PB-00 = 1), the swing AW = maximum frequency P0-10 × swing amplitude PB-01.

The frequency of the bounce frequency is the percentage of the frequency of the bounce frequency relative to the swing when the wobble frequency is run. If the swing is selected relative to the center frequency (PB-00 = 0), the sudden frequency is the change value. If the swing is selected relative to the maximum frequency (PB-00 = 1), the spurious frequency is a fixed value.

The frequency of the wobble is limited by the upper and lower frequencies.

PB-03	Wobble cycle	Factory default	10.0s
	Set range	0.0s ~ 3000.0s	
PB-04	Triangular wave rise time coefficient	Factory default	50.0%
	Set range	0.0% ~ 100.0%	

Wobble cycle: the time value of a complete wobble cycle.

The triangular wave rise time coefficient PB-04 is the percentage of time that the triangular wave rise time is relative to the wobble cycle PB-03. Triangle wave rise time = wobble cycle PB-03 × triangular wave rise time coefficient PB-04, in seconds.

Triangle wave fall time = wobble cycle PB-03 × (1-triangular wave rise time factor PB-04) in seconds.

PB-05	Set length	Factory default	1000m
	Set range	0m ~ 65535m	
PB-06	Actual length	Factory default	0m
	Set range	0m ~ 65535m	
PB-07	Number of pulses per meter	Factory default	100.0
	Set range	0.1 ~ 6553.5	

The above function codes are used for fixed length control.

The length information needs to be collected by the multi-function digital input terminal. The number of pulses sampled by the terminal is divided by the number of pulses per minute PB-07, and the actual length PB-06 can be calculated. When the actual length is greater than the set length PB-05, the multi-function digital HDO outputs the "length arrival" ON signal.

During the length control process, the length reset operation (S function selection is 28) can be performed via the multi-function S terminal. For details, refer to P4-00 to P4-09.

In the application, the corresponding input terminal function needs to be set to "length count input" (function 27), and the S5 port must be used when the pulse frequency is high.

PB-08	Set the count value	Factory default	1000
	Set range	1 ~ 65535	
PB-09	Specify the count value	Factory default	1000
	Set range	1 ~ 65535	

The count value needs to be collected via the multi-function digital input terminal. In the application, the corresponding input terminal function is set to "Counter input" (function 25), and the S5 port must be used when the pulse frequency is high.

When the count value reaches the set count value PB-08, the multi-function digital HDO output "sets the count value to the ON" signal, and the counter stops counting.

When the count value reaches the specified count value PB-09, the multi-function digital HDO outputs the "specified count value arrival" ON signal, and the counter continues counting until the counter is stopped when "Set count value" is set.

The specified count value PB-09 should not be greater than the set count value PB-08. Figure 6-29 for the set count to reach and specify the count value to reach the function of the diagram.

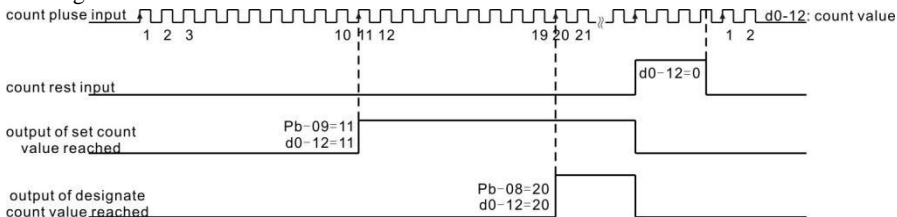

Figure 6-29 Set the count value for the given and specified count values

PC Group Multi-segment instructions and simple PLC functions

DSI-200 multi-segment instructions, than the normal multi-speed has a richer function, in addition to multi-speed function, but also as a VF separation of the voltage source, and the process PID given source. For this reason, the dimensions of the multi-segment instructions are relative values.

Simple PLC function is different from the EV510 user programmable function, simple PLC can only complete the simple combination of multi-segment instructions. And user-programmable features to be richer and more practical, please refer to A7 group related

instructions.

PC-00~ PC-15	Multi command 0~15	Factory default	0.0%
	Set range	-100.0% ~ 100.0%	

Multi-segment instructions can be used in three cases: as a frequency source, as VF separation of the voltage source, as the process PID set the source.

In the three applications, the dimension of the multi-segment instruction is the relative value, the range is -100.0% ~ 100.0%, which is the percentage of the relative maximum frequency when it is the frequency source. When the VF is the isolated voltage source, Percentage; and since the PID reference is originally a relative value, the multi-segment instruction as the PID setting source does not require dimension conversion.

Multi-segment instructions need to switch according to the different state of multi-function digital S, please refer to the relevant instructions for the P4 group.

PC-16	Simple PLC operation way	Factory default	0
	Set range	0: Single run end stop 1: End of single run to maintain final value 2: Always loop	

Simple PLC functions have two functions: as a frequency source or as a voltage source for VF separation.

Figure 6-30 is a schematic diagram of a simple PLC as a frequency source. Simple PLC as a frequency source, PC-00 ~ PC-15 positive and negative determine the direction of operation, if the negative value that the inverter running in the opposite direction.

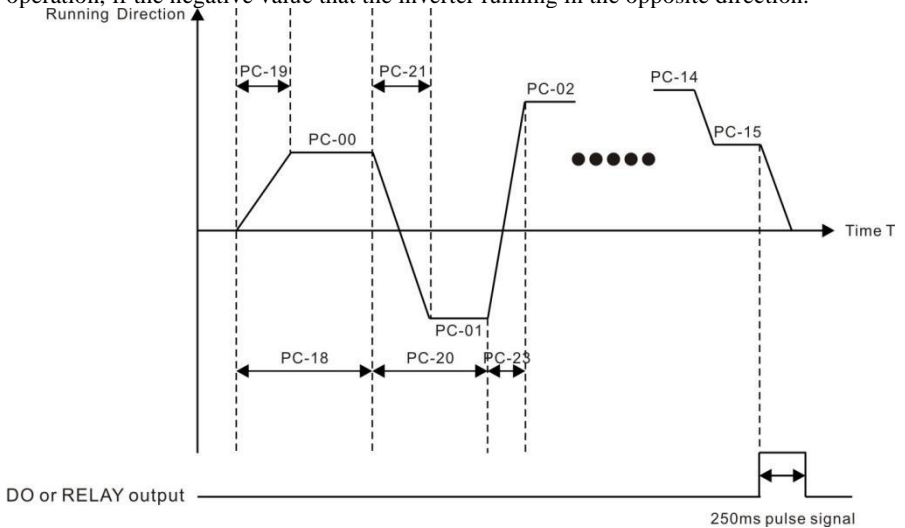

Figure 6-30 simple PLC diagram

As a frequency source, PLC has three operating modes, as VF separation voltage source does not have these three ways. Among them:

- 0: single run end stop
The inverter to complete a single cycle after the automatic shutdown, you need to give a run command to start again.
- 1: the end of a single run to maintain the final value
After the inverter completes a single cycle, it automatically keeps the last running frequency and direction.
- 2: has been circulating
After the inverter completes a cycle, the next cycle is automatically started until the stop command is stopped.

PC-17	Simple PLC power loss memory selection	Factory default	00
	Set range	Bit	Power-down memory selection
		0 : Power-down no memory	
		1 : Power-down memory	
Ten		stop memory selection	
0: no memory		1: downtime memory	

PLC power-down memory is memory before power-down PLC running phase and operating frequency, the next power from the memory stage to continue to run. Select no memory, then each time the power is to restart the PLC process.

PLC shutdown memory is recorded when the previous record of the PLC running phase and operating frequency, the next run from the memory stage to continue running. Select no memory, then start each time to start the PLC process.

PC-18	Easy PLC run time 0	Factory default	0.0s (h)
	Set range	0.0s (h) ~ 6553.5s (h)	
PC-19	Easy PLC paragraph 0 acceleration / deceleration time	Factory default	0
	Set range	0 ~ 3	
PC-20	Simple PLC 1st run time	Factory default	0.0s (h)
	Set range	0.0s (h) ~ 6553.5s (h)	
PC-21	Easy PLC paragraph 1 acceleration / deceleration time	Factory default	0
	Set range	0 ~ 3	
PC-22	Simple PLC 2nd run time	Factory default	0.0s (h)
	Set range	0.0s (h) ~ 6553.5s (h)	
PC-23	Easy PLC paragraph 2 acceleration / deceleration time	Factory default	0

	Set range	0 ~ 3	
PC-24	Simple PLC third run time	Factory default	0.0s (h)
	Set range	0.0s (h) ~ 6553.5s (h)	
PC-25	Easy PLC paragraph 3 acceleration / deceleration time	Factory default	0
	Set range	0 ~ 3	
PC-26	Simple PLC 4th run time	Factory default	0.0s (h)
	Set range	0.0s (h) ~ 6553.5s (h)	
PC-27	Easy PLC paragraph 4 acceleration / deceleration time	Factory default	0
	Set range	0 ~ 3	
PC-28	Simple PLC fifth run time	Factory default	0.0s (h)
	Set range	0.0s (h) ~ 6553.5s (h)	
PC-29	Easy PLC paragraph 5 acceleration / deceleration time	Factory default	0
	Set range	0 ~ 3	
PC-30	Simple PLC 6th run time	Factory default	0.0s (h)
	Set range	0.0s (h) ~ 6553.5s (h)	
PC-31	Easy PLC paragraph 6 acceleration / deceleration time	Factory default	0
	Set range	0 ~ 3	
PC-32	Simple PLC 7th run time	Factory default	0.0s (h)
	Set range	0.0s (h) ~ 6553.5s (h)	
PC-33	Easy PLC paragraph 7 acceleration / deceleration time	Factory default	0
	Set range	0 ~ 3	
PC-34	Simple PLC 8th run time	Factory default	0.0s (h)
	Set range	0.0s (h) ~ 6553.5s (h)	
PC-35	Easy PLC paragraph 8 acceleration / deceleration time	Factory default	0
	Set range	0 ~ 3	

PC-36	Simple PLC ninth run time	Factory default	0.0s (h)
	Set range	0.0s (h) ~ 6553.5s (h)	
PC-37	Easy PLC paragraph 9 acceleration / deceleration	Factory default	0
	Set range	0 ~ 3	
PC-38	Simple PLC tenth run time	Factory default	0.0s (h)
	Set range	0.0 s (h) ~ 6553.5s (h)	
PC-39	Easy PLC paragraph 10 acceleration / deceleration	Factory default	0
	Set range	0 ~ 3	
PC-40	Simple PLC eleventh run time	Factory default	0.0s (h)
	Set range	0.0s (h) ~ 6553.5s (h)	
PC-41	Easy PLC paragraph 11 acceleration / deceleration	Factory default	0
	Set range	0 ~ 3	
PC-42	Simple PLC twelfth run time	Factory default	0.0s (h)
	Set range	0.0s (h) ~ 6553.5s (h)	
PC-43	Easy PLC paragraph 12 acceleration / deceleration	Factory default	0
	Set range	0 ~ 3	
PC-44	Simple PLC thirteenth run time	Factory default	0.0s (h)
	Set range	0.0s (h) ~ 6553.5s (h)	
PC-45	Easy PLC paragraph 13 acceleration / deceleration	Factory default	0
	Set range	0 ~ 3	
PC-46	Simple PLC fourteenth run time	Factory default	0.0s (h)
	Set range	0.0s (h) ~ 6553.5s (h)	

PC-47	Easy PLC paragraph 14 acceleration / deceleration	Factory default	0
	Set range	0 ~ 3	
PC-48	Simple PLC fifteenth run time	Factory default	0.0s (h)
	Set range	0.0s (h) ~ 6553.5s (h)	
PC-49	Easy PLC paragraph 15 acceleration / deceleration	Factory default	0
	Set range	0 ~ 3	
PC-50	Simple PLC run time unit	Factory default	0
	Set range	0 : S (s)	1 : h (h)
PC-51	Multi-step instruction 0 given mode	Factory default	0
	Set range	0: Function code PC-00 reference 1: AI1 2: AI2 3: AI3 4: High speed pulse input 5: PID 6: Preset frequency (P0-08) is given, UP / DOWN can be modified	

This parameter determines the given channel for multi-step instruction 0.

In addition to the PC-00, there are a number of other options that allow you to toggle between multiple short and other ways. In the multi-segment instructions as a frequency source or simple PLC as a frequency source, can easily achieve the two frequency source switching

Pd Group Communication parameters

Please refer to "communication protocol"

PP Group user password

PP-00	User password	Factory default	0
	Set range	0 ~ 65535	

PP-00 set any non-zero number, the password protection function to take effect. The next time you enter the menu, you must enter the correct password, or cannot view and modify the function parameters, please keep in mind the user password set. Set the PP-00 to 00000, then clear the set user password, so that the password protection function is invalid.

A0 Group Torque control and qualification

A0-00	Speed / torque control mode selection	Factory default	0
	Set range	0: Speed control	1: Torque control

Used to select the inverter control mode: speed control or torque control.

DSI-200 multi-function digital S terminal, with two torque control related functions: torque control disabled (function 29), speed control / torque control switch (function 46). The two

terminals should be used in conjunction with A0-00 to achieve speed and torque control switching.

When the speed control / torque control switching terminal is invalid, the control mode is determined by A0-00. If the speed control / torque control switching is valid, the control mode is equivalent to the value of A0-00.

In any case, when the torque control inhibit terminal is valid, the inverter is fixed to the speed control mode..

A0-01	Torque control mode torque setting source selection	Factory default	0
	Set range	0 : digital default (A0-03) 1 : AI1 2 : AI2 3 : AI3 4 : High speed pulse input setting(S5) 5 : Communication given 6 : MIN (AI1,AI2) 7 : MAX (AI1,AI2)	
A0-03	Torque control mode torque setting	Factory default	150.0%
	Set range	-200.0% ~ 200.0%	

A0-01 is used to select the torque setting source, and there are 8 kinds of torque setting modes.

The torque setting uses the relative value, 100.0% corresponds to the rated torque of the inverter. The setting range is -200.0% ~ 200.0%, indicating that the maximum torque of the inverter is 2 times the rated torque of the inverter.

When the torque is given positive, the inverter is running forward when the torque is set to negative, the inverter is running reversely

The torque setting sources are described as follows:

- 0 : digital setting (A0-03)

The target torque is used directly with the A0-03 setting

- 1 : AI1
- 2 : AI2
- 3 : AI3

The target torque is determined by the analog input terminal. EV510 control board provides three analog input terminals (AI1, AI2, AI3).

AI1 is 0V ~ 10V voltage input, through the J6 jumper selection panel potentiometer or external potentiometer

AI2 can be 0V ~ 10V voltage input, but also for the 4mA ~ 20mA current input, by the control board J4 jumper selection

AI3 is -10V ~ 10V voltage input

AI1, AI2, AI3 input voltage value, and the target torque of the corresponding curve, the user can choose freely through the P4-33.

DSI-200 provides five groups of corresponding relationship curve, in which three groups of curves for the linear relationship (2-point correspondence), 2 groups of 4 points corresponding to any curve, the user can use P4-13 ~ P4-27 function code and A6 group function Code to set.

Function code P4-33 is used to set AI1 ~ AI3 three analog input, select which of the five groups of curves.

AI as the frequency given, the voltage and current input corresponding to the set of 100.0%, refers to the relative torque digital set A0-03 percentage

➤ 4: High-speed pulse setting (S5)

The target torque reference is given by the terminal S5 high speed pulse.

Pulse given signal specifications: voltage range 9V ~ 30V, the frequency range 0kHz ~ 100kHz. The pulse reference can only be input from the multi-function input terminal S5. The relationship between the pulse frequency of the S5 terminal input and the corresponding setting is set by P4-28 to P4-31. The correspondence relationship is a linear relationship of 2 points, and 100.0% of the pulse input is the relative torque number A0-03 percentage.

➤ 5 : Communication given

Refers to the target torque postal communication mode given

When a point-to-point communication slave is received and the received data is given as a torque, use the host to transfer data as the communication reference (see A8 group description)

Otherwise the host computer through the communication address 0×1000 given data, the data format is -100.00% to 100.00%, 100.00% refers to the relative torque digital set A0-03 percentage.

A0-05	Torque control forward maximum frequency		Factory default	50.00Hz
	Set range	0.00Hz ~ max frequency (P0-10)		
A0-06	Torque control reverse maximum frequency		Factory default	50.00Hz
	Set range	0.00Hz ~ max frequency (P0-10)		

Used to set the torque control mode, the inverter's forward or reverse maximum operating frequency.

When the inverter torque control, if the load torque is less than the motor output torque, the motor speed will continue to rise, in order to prevent the mechanical system, such as flying accidents, must limit the torque control motor maximum speed.

If you need to achieve dynamic continuous change torque control maximum frequency, you can use the control of the upper frequency of the way to achieve.

A0-07	Torque control acceleration time		Factory default	0.00s
	Set range	0.00s ~ 65000s		

A0-08	Torque control deceleration time	Factory default	0.00s
	Set range	0.00s ~ 65000s	

In the torque control mode, the difference between the output torque and the load torque of the motor determines the speed change rate of the motor and the load. Therefore, the motor speed may change rapidly, resulting in excessive noise or mechanical stress. By setting the torque control acceleration / deceleration time, the motor speed can be changed gently.

However, if the torque response is required, it is necessary to set the torque control acceleration / deceleration time to 0.00s.

For example: two motor hard link drag the same load, in order to ensure uniform distribution of the load, set a frequency converter for the host, the use of speed control, another inverter for the machine and the use of torque control, the actual output of the host Moment as the torque command from the slave, then the torque of the slave machine needs to follow the host quickly, then the torque control acceleration / deceleration time of the slave is 0.00s.

A5 Group Control optimization parameters

A5-00	DPWM Switch the upper limit frequency	Factory default	8.00Hz
	Set range	5.00Hz ~ max frequency	

Only valid for VF control.

Asynchronous machine VF running time to determine the way, below this value for the 7-segment continuous modulation mode, on the contrary for the 5-segment intermittent modulation.

The switching loss of the inverter is larger when the 7-stage continuous modulation is larger, but the current ripple is smaller. The switching loss is smaller and the current ripple is larger in the 5-stage intermittent modulation mode, but it may lead to high frequency The instability of the motor operation, generally do not need to be modified.

Refer to function code P3-11 for VF operation instability. Refer to function code P0-15 for inverter loss and temperature rise.

A5-01	PWM Modulation mode	Factory default	0
	Set range	0: Asynchronous modulation modulation 1: Synchronous modulation	

Only valid for VF control.

Synchronous modulation, refers to the carrier frequency with the output frequency conversion and linear changes to ensure that the ratio of the two (carrier ratio) unchanged, generally used in the output frequency is high, is conducive to the output voltage quality.

At lower output frequencies (below 100 Hz), it is generally not necessary to synchronize the modulation because the ratio of the carrier frequency to the output frequency is relatively high and the asynchronous modulation advantage is more pronounced.

When the operating frequency is higher than 85Hz, the synchronous modulation takes effect, and the frequency is fixed as asynchronous modulation mode.

A5-03	Random PWM depth		0
	Setting Range	0 : Random PWM invalid 1 ~ 10 : PWM Carrier frequency random depth	

Set random PWM, you can monotonous harsh motor sound becomes more soft, and can help reduce the external electromagnetic interference. When the random PWM depth is set to 0, the random PWM is disabled. Adjusting the random PWM at different depths will result in different effects.

Set random PWM, you can monotonous harsh motor sound becomes more soft, and can help reduce the external electromagnetic interference. When the random PWM depth is set to 0, the random PWM is disabled. Adjusting the random PWM at different depths will result in different effects.

A5-04	Over current fast	Factory default	1
	Set range	0: Disabled 1: Enabled	

Enable fast current limit function, to minimize the inverter over current fault, to ensure that the inverter running without interruption.

If the inverter is in a fast current limit for a long time, the inverter may be overheated and other damage. This is not allowed. Therefore, the inverter will fail to meet the fault time for a long time, indicating that the inverter is overloaded and needs to be shut down.

A5-05	Voltage over modulation coefficient	Factory default	105%
	Set range	100~110%	

A6 Group AI Curve setting

A6-00	AI curve 4 min. input	Factory default	0.00V
	Set range	-10.00V ~ A6-02	
A6-01	Corresponding percentage of AI curve 4 min. input	Factory default	0.0%
	Set range	-100.0% ~ 100.0%	
A6-02	AI curve 4 inflexion 1 input	Factory default	3.00V
	Set range	A6-00 ~ A6-04	
A6-03	Corresponding percentage of AI curve 4 inflexion 1 input	Factory default	30.0%
	Set range	-100.0% ~ 100.0%	
A6-04	AI curve 4 inflexion 2 input	Factory default	6.00V
	Set range	A6-02 ~ A6-06	

A6-05	Corresponding percentage of AI curve 4 inflexion 2 input	Factory default	60.0%
	Set range	-100.0% ~ 100.0%	
A6-06	AI curve 4 max. input	Factory default	10.00V
	Set range	A6-06 ~ 10.00V	
A6-07	Corresponding percentage of AI Curve 4 max. input	Factory default	100.0%
	Set range	-100.0% ~ 100.0%	
A6-08	AI curve 4 min. input	Factory default	0.00V
	Set range	-10.00V ~ A6-10	
A6-09	Corresponding percentage of AI curve 5 min. input	Factory default	0.0%
	Set range	-100.0% ~ 100.0%	
A6-10	AI curve 5 inflexion 1 input	Factory default	3.00V
	Set range	A6-08 ~ A6-12	
A6-11	Corresponding percentage of AI curve 5 inflexion 1 input	Factory default	30.0%
	Set range	-100.0% ~ 100.0%	
A6-12	AI curve 5 inflexion 2 input	Factory default	6.00V
	Set range	A6-10 ~ A6-14	
A6-13	Corresponding percentage of AI curve 5 inflexion 2 input	Factory default	60.0%
	Set range	-100.0% ~ 100.0%	
A6-14	AI curve 5 max. input	Factory default	10.00V
	Set range	A6-14 ~ 10.00V	
A6-15	Corresponding percentage of AI Curve 5 max. input	Factory default	100.0%
	Set range	-100.0% ~ 100.0%	

The functions of curves 4 and 5 are similar to those of curves 1 to 3, but curves 1 to 3 are straight lines, and curves 4 and 4 are 4-point curves, and a more flexible correspondence can be achieved. Figure 6-31 for the curve 4 to curve 5 of the schematic.

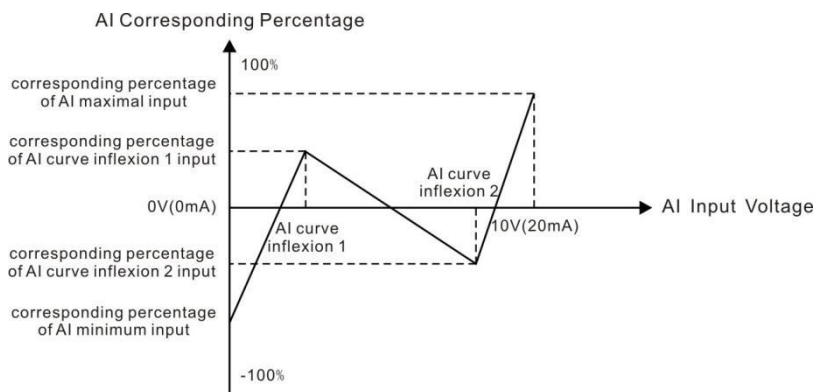

Figure 6-31 Curve 4 and Curve 5 Schematic

Curve 4 and curve 5 should be noted that the minimum input voltage curve, the inflection point 1 voltage, inflection point 2 voltage, the maximum voltage must be increased in turn. AI curve selection P4-33, used to determine the analog input AI1 ~ AI3 how to choose from 5 curves.

A6-24	AI1 Set jump point	Factory default	0.0%
	Set range	-100.0% ~ 100.0%	
A6-25	AI1 Set the jump range	Factory default	0.5%
	Set range	0.0% ~ 100.0%	
A6-26	AI2 Set jump point	Factory default	0.0%
	Set range	-100.0% ~ 100.0%	
A6-27	AI2 Set the jump range	Factory default	0.5%
	Set range	0.0% ~ 100.0%	

The jump function means that when the analog quantity is set at the upper and lower range of the jump point, the analog value corresponding to the set value is fixed to the value of the jump point.

For example :

The analog input AI1 voltage fluctuates above 5.00V, the fluctuation range is 4.90V ~ 5.10V, the AI1 minimum input 0.00V corresponds to 0.0%, the maximum input 10.00V corresponds to 100.%, then the detected AI1 correspondence is set at 49.0% ~ 51.0% fluctuate.

Set the AI1 to set the jump point A6-24 to 50.0%, set AI1 to set the jump amplitude A6-25 to 1.0%, then the AI1 input, after the jump function processing, the AI1 input corresponding to the fixed set to 50.0% AI1 is transformed into a stable input, eliminating the fluctuation.

d0 Group Monitor the parameter group

d0 parameter group is used to monitor the inverter running status information, the customer can view through the panel to facilitate on-site debugging, you can also read the

parameters through the communication value for the host computer monitoring. The communication address is $0 \times 7000 \sim 0 \times 7040$

Where d0-00 to d0-31 are the run and stop monitoring parameters defined in P7-03 and P7-04.

d0-15	PID setting	Display range	0 ~ 65535
d0-16	PID feedback	Display range	0 ~ 65535

Display PID set value and feedback value, the value format is as follows:

PID setting = PID setting (percentage) * PA-04

PID feedback = PID feedback (percentage) * PA-04

Chapter 7 Fault Display and settlement

7.1 Guidance on the adjustment of the inverter before commissioning

1) Drive in Open-loop Vector Control (P0-01=0)

The AC drive implements control of the motor speed and torque without an encoder for speed feedback. In this control mode, motor auto-tuning is required to obtain the motor related

Error	Solution
Overload or Over current detected during motor start	<ul style="list-style-type: none"> ◆ Set motor parameters (P1-01~P1-05) according to motor nameplate. ◆ Select a proper motor auto-tuning mode by setting P1-37 and perform motor auto-tuning. If possible, select dynamic auto-tuning
Poor torque or speed response and motor oscillation at speeds below 5 Hz	<ul style="list-style-type: none"> ◆ 1. If motor torque and speed response are too slow, increase the setting of P2-00 (speed loop proportional gain 1) by 10 gradually or decrease the setting of P2-01 (speed loop integral time 1) by 0.05 gradually. ◆ 2. If motor oscillation occurs, decrease the setting of P2-00 and P2-01.
Poor torque or speed response and motor oscillation at speeds above 5 Hz	<ul style="list-style-type: none"> ◆ 1. If motor torque and speed response are too slow, increase the setting of P2-03 (speed loop proportional gain 2) by 10 gradually or decrease. The setting of P2-04 (speed loop integral time 4) by 0.05 gradually. ◆ 2. If motor oscillation occurs, decrease the setting of P2-03 and P2-04.
Low speed accuracy	<ul style="list-style-type: none"> ◆ If speed error when motor runs with load is large, increase the setting of P2-06 (vector control slip compensation gain) by 10% gradually.
Obvious speed fluctuation	<ul style="list-style-type: none"> ◆ If motor speed fluctuation is large, increase the setting of P2-07 (SVC torque filter time) by 0.001s gradually.

Too loud motor noise	◆ Increase the setting of P0-15 (carrier frequency) by 1.0 kHz gradually. Note that increase in carrier frequency will result in an increase in the leakage current of the motor.
Insufficient motor torque	◆ Check whether torque upper limit is small. If yes, please Increase the setting of P2-10 (digital setting of torque upper limit in speed control mode) in the speed control mode; Increase the torque reference in the torque control mode.

2) Drive in Feedback Vector Control (P0-01 = 1)

It is applicable to the application with an encoder for speed feedback. In this mode, you need to set the encoder pulses per revolution, the encoder type and the encoder direction correctly.

ERROR	Solution
Overload or over current fault detected during motor start	◆ Set P1-27, P1-28 and P1-30 correctly.
Over load or over current detected during motor running	◆ Set motor parameters p1-01 to P1-05 according to the motor nameplate. ◆ Select a proper motor auto-tuning mode by setting P1-37 and perform motor auto-tuning. If possible, select dynamic auto-tuning
Poor torque or speed response and motor oscillation at speeds below 5 Hz	◆ If motor torque and speed response are too slow, increase the setting of P2-00 (speed loop proportional gain 1) by 10 gradually or decrease the setting of P2-01 (speed loop integral time 1) by 0.05 gradually ◆ If motor oscillation occurs, decrease the setting of P2-00 and P2-01.
Poor torque or speed response and motor oscillation at speeds above 5 Hz	◆ If motor torque and speed response are too slow, increase the setting of P2-03 (speed loop proportional gain 2) by 10 gradually or decrease the setting of P2-04 (speed loop integral time 4) by 0.05 gradually. ◆ If motor oscillation occurs, decrease the setting of P2-03 and P2-04.
Obvious speed fluctuation	◆ If motor speed fluctuation is large, increase the setting of P2-07 (SVC torque filter time) by 0.001s gradually.
Too loud motor noise	◆ Increase the setting of P0-15 (carrier frequency) by 1.0 kHz gradually. Note that increase in carrier frequency will result in an increase in the leakage current of the motor.
Insufficient motor torque	◆ Check whether torque upper limit is small. If yes, please: Increase the setting of P2-10 (digital setting of torque upper limit in speed control mode) in the speed control mode.

3) Drive in V/F Control (P0-01=2 factory default)

It is applicable to application without an encoder for speed feedback. You need to set rated Motor voltage and rated motor frequency correctly.

Error	Solution
Motor oscillation during running	1. Increase the setting of P3-11 (V/F oscillation suppression gain) by 10 gradually. The permissible maximum setting here is 100.
Over current during start	1. Decrease the setting of P3-01 (torque boost) by 0.5% gradually.
Too loud motor noise	1. Increase the setting of P0-15 (carrier frequency) by 1.0 kHz gradually. Note that increase in carrier frequency will result in an increase in the leakage current of the motor.
Very large current during running	1. Set rated motor voltage (P1-02) and rated motor frequency (P1-04) correctly. 2. Decrease the setting of P3-01 (torque boost) by 0.5% gradually.
Over voltage detected when heavy load is suddenly removed or during deceleration	1. Ensure that P3-23 (voltage limit selection) is set to 1 (enabled). Increase the setting of P3-24/P3-25 (frequency gain/voltage gain for voltage limit) by 10 gradually. The permissible maximum setting here is 100. 2. Decrease the setting of P3-22 (voltage limit 770v) by 10 V gradually. The permissible minimum setting here is 700 V.
Over current detected when heavy load is suddenly added or during acceleration	1. Increase the setting of P3-20 (93-20 factory default set 20) by 10 gradually. The permissible maximum setting here is 100. 2. Decrease the setting of P3-18 (P3-18 factory default is 150%) by 10% gradually. The permissible minimum setting here is 50%.

8.2 Fault Display

When a fault occurs during running, the operation panel displays the fault code such as shown in the following figure.

Fault	display	Fault reason	Error settlement
Over current during acceleration	FU02	Ground fault or short circuit exists in the output circuit.	◆ Check whether short-circuit occurs on the motor, motor cable or contactor.
		Control mode is FVC or SVC but motor auto-tuning is not performed.	◆ Set motor parameters according to motor nameplate and perform motor auto-tuning.
		Acceleration time is too short.	◆ Increase acceleration time.
		The over current stall prevention parameters are set improperly.	◆ Ensure that current limit is enabled (P3-19 = 1). ◆ The setting of current limit level (P3-18) is too large. Adjust it between 120% and 150%. ◆ The setting of current limit gain (P3-20) is too small. Adjust it between 20 and 40.

		Customized torque boost or V/F curve is not appropriate.	◆ Adjust the customized torque boost or V/F curve.
		The spinning motor is started.	◆ Enable the catching a spinning motor function or start the motor
		The AC drive suffers external interference.	◆ View historical fault records. If the current value is far from the over current level, find interference source. If external interference does not exist, it is the drive board or hall device problem.
Over current during deceleration	FU03	Ground fault or short circuit exists in the output circuit.	◆ Check whether short-circuit occurs on the motor, motor cable or contactor.
		Control mode is SVC or FVC but motor auto-tuning is not performed.	◆ Set the motor parameters according to the motor nameplate and perform motor auto-tuning.
		Acceleration time is too short.	◆ Increase acceleration time.
		The over current stall prevention parameters are set improperly.	◆ Ensure that current limit is enabled (p3-19 = 1) ◆ The setting of current limit level (p3-18) is too large. Adjust it between 120% and 150%. ◆ The setting of the current limit gain (p3-20) is too small. Adjust it between 20 and 40.
		Braking unit and braking resistor are not installed.	◆ Install braking unit and braking resistor.
		The AC drive suffers external interference.	◆ View historical fault records. If the current value is far from the over current level, find interference source. If external interference does not exist, it is the drive board or hall device problem.
Over current at constant speed	FU04	Ground fault or short circuit exists in the output circuit.	◆ Check whether short-circuit occurs on the motor, motor cable or contactor.
		Control mode is SVC or FVC but motor auto-tuning is not performed.	◆ Set motor parameters according to motor nameplate and perform motor auto-tuning.

7.2 Faults and Diagnostics

Troubleshoot the fault according to the following table. If the fault cannot be eliminated, contact the agent.

		The over current stall prevention parameters are set improperly.	<ul style="list-style-type: none"> ◆ Ensure that current limit is enabled (P3-19). ◆ The setting of current limit level (P3-18) is too large. Adjust it between 120% and 150%. ◆ The setting of current limit gain (P3-20) is too small. Adjust it between 20 and 40.
		The AC drive power class is small.	<ul style="list-style-type: none"> ◆ If output current exceeds rated motor current or rated output current of the AC drive during stable running, replace a drive of larger power class.
		The drive suffers external interference.	<ul style="list-style-type: none"> ◆ View historical fault records. If the current value is far from the over current level, find interference source. If external interference does not exist, it is the drive board or hall device problem.
Over voltage during acceleration	FU05	Input voltage is too high.	<ul style="list-style-type: none"> ◆ Adjust input voltage to normal range.
		An external force drives motor during acceleration.	<ul style="list-style-type: none"> ◆ Cancel the external force or install a braking resistor.
		The over voltage stall prevention parameters are set improperly.	<ul style="list-style-type: none"> ◆ Ensure that the voltage limit function is enabled (P3-23). ◆ The setting of voltage limit (P3-22) is too large. Adjust it between 700 V and 770 V. ◆ The setting of frequency gain for voltage limit (P3-24) is too small. Adjust it between 30 and 50.
		Braking unit and braking resistor are not installed.	<ul style="list-style-type: none"> ◆ Install braking unit and braking resistor.
		Acceleration time is too short.	<ul style="list-style-type: none"> ◆ Increase acceleration time.
Over voltage during deceleration	FU06	The over voltage stall prevention parameters are set improperly.	<ul style="list-style-type: none"> ◆ Ensure that the voltage limit function is enabled (P3-23). ◆ The setting of voltage limit (P3-22) is too large. Adjust it between 700 V and 770 V. ◆ The setting of frequency gain for voltage limit (P3-24) is too small. Adjust it between 30 and 50.
		An external force drives motor during deceleration.	<ul style="list-style-type: none"> ◆ Cancel the external force or install braking resistor.

		Deceleration time is too short.	◆ Increase deceleration time.
		Braking unit and braking resistor are not installed.	◆ Install braking unit and braking resistor.
Over voltage at constant speed	FU07	The over voltage stall prevention parameters are set improperly.	◆ Ensure that the voltage limit function is enabled (P3-23) ◆ The setting of voltage limit (F3-22) is too large. Adjust it between 700 V and 770 V. ◆ The setting of frequency gain for voltage limit (P3-24) is too small. Adjust it between 30 and 50. ◆ The setting of frequency rise threshold during voltage limit (P3-26) is too small. Adjust it between 5 Hz and 20 Hz.
		An external force drives motor during running.	◆ Cancel the external force or install a braking resistor
Pre-charge resistor fault	FU08	Input voltage is not in arranged range	◆ Arrange voltage in a reasonable range
Under voltage	FU09	Instantaneous power failure occurs	◆ Enable the power dip ride through function (P9-59).
		The AC drive's input voltage is not within the permissible range.	◆ Adjust the voltage to normal range.
		The bus voltage is abnormal.	◆ Contact the agent
		The rectifier bridge, the buffer resistor, the drive board or the control board are abnormal.	◆ Contact the agent
AC drive overload	FU10	Load is too heavy or locked-rotor occurs on motor.	◆ Reduce load or check motor and mechanical conditions.
		The AC drive power class is small.	◆ Replace a drive of larger power class.
Motor overload	FU11	P9-01 (Motor overload protection gain) is set improperly.	◆ Set P9-01 correctly.
		Load is too heavy or locked-rotor occurs on motor.	◆ Reduce load or check motor and mechanical conditions.

Output phase loss	FU13	Motor winding is damaged.	<ul style="list-style-type: none"> ◆ Check resistance between motor wires. ◆ Replace motor is winding is damaged.
		The cable connecting the AC drive and the motor is abnormal.	<ul style="list-style-type: none"> ◆ Check for wiring errors and ensure the output cable is connected properly correct wiring.
		The AC drive's three-phase outputs are unbalanced when the motor is running.	<ul style="list-style-type: none"> ◆ Check whether the motor three-phase winding is normal.
		The drive board or the IGBT is abnormal.	<ul style="list-style-type: none"> ◆ Contact the agent
overheat	FU14	The ambient temperature is too high.	<ul style="list-style-type: none"> ◆ Lower the ambient temperature.
		The ventilation is clogged.	<ul style="list-style-type: none"> ◆ Clean the ventilation.
		The fan is damaged.	<ul style="list-style-type: none"> ◆ Replace the cooling fan.
		Thermally sensitive resistor of IGBT is damaged.	<ul style="list-style-type: none"> ◆ Replace the damaged thermally sensitive resistor.
		The AC Drive Inverter module is damaged.	<ul style="list-style-type: none"> ◆ Replace the AC Drive Inverter module.
Out project fault	FU15	External fault signal is input via S.	<ul style="list-style-type: none"> ◆ Confirm that the mechanical condition allows restart (P8-18) and reset the operation.
Communication fault	FU16	Host computer is in abnormal state.	<ul style="list-style-type: none"> ◆ Check the cable of host computer.
		Communication cable is abnormal.	<ul style="list-style-type: none"> ◆ Check the communication cables.
		The serial port communication protocol (P0-28) of extension communication card is set improperly.	<ul style="list-style-type: none"> ◆ Set extension communication card correctly.
		Communication parameters in group Pd are set improperly.	<ul style="list-style-type: none"> ◆ Set communication parameters in group Pd properly.
		After all the preceding checking are done but the fault still exists, restore the default settings.	
Contactor fault	FU17	Drive board and power supply are abnormal.	<ul style="list-style-type: none"> ◆ Replace drive board or power supply board.
		Contactor is abnormal.	<ul style="list-style-type: none"> ◆ Replace contactor.
		The lightning protection board is abnormal.	<ul style="list-style-type: none"> ◆ Replace the lightning protection board.

Current detection failure	FU18	The hall is abnormal.	◆ Replace the hall.
		The drive board is abnormal.	◆ Replace the drive board.
Motor self-learning malfunction	FU19	Motor parameters are not set according to nameplate.	◆ Set motor parameters correctly according to nameplate.
		Motor auto-tuning times out.	◆ Check the cable connecting AC drive and motor.
		The encoder is abnormal.	◆ Check whether P1-27 (encoder pulses per revolution) is set correctly. Check whether signal lines of encoder are connected correctly and securely.
Encoder fault	FU20	Encoder is not matched.	◆ Set the type of encoder correctly.
		Encoder wiring is incorrect.	◆ Check the PG card power supply and phase sequence.
		Encoder is damaged.	◆ Replace encoder.
		PG card is abnormal.	◆ Replace PG card.
EEPROM read-write fault	FU21	The EEPROM chip is damaged.	◆ Replace the main control board.
Short circuit to ground	FU23	Motor is short circuited to the ground.	◆ Replace cable or motor.
Accumulative running time reached	FU26	Accumulative running time reaches the setting value.	◆ Clear the record through parameter initialization.
User-defined fault 1	FU27	User-defined fault 1 is input via S.	◆ Reset the operation.
User-defined fault 2	FU28	User-defined fault 2 is input via virtual S	◆ Reset the operation.
Accumulative power reach error	FU29	Accumulative power-on time reached	◆ Use the parameter initialization function to clear the record information
Load loss	FU30	Working current <P9-64	◆ Check whether the load is off or P9-64, P9-65 parameter set Whether to meet the actual operating conditions
PID feedback lost during running	FU31	PID feedback <PA-26 set value	◆ Check PID feedback or set PA-26 properly.

Pulse-by-pulse current limit fault	FU40	Load is too heavy or locked-rotor occurs on Motor.	◆ Reduce load or check motor and mechanical conditions
		The AC drive power class is small.	◆ Replace a drive of larger power class.
Motor switchover fault during running	FU41	Motor switchover via terminal during drive Running of the AC drive.	◆ Perform motor switchover after the AC drive stops.
Speed error	FU42	Encoder parameters are set improperly.	◆ Set encoder parameters properly.
		Motor auto-tuning is not performed.	◆ Perform motor auto-tuning.
		P9-69 (detection level of speed error) and P9-70 (detection time of speed error) are set Incorrectly.	◆ Set data correctly based on actual condition
Motor over speed	FU43	Encoder parameters are set improperly.	◆ Set encoder parameters properly.
		Motor auto-tuning is not performed.	◆ Perform motor auto-tuning.
		P9-67 (Over speed detection level) and P9-68 (Over speed detection time) are set Incorrectly.	◆ Set data correctly based on the actual situation.

No.	Error	Reason	Possible Solution
1	There is no display while power-on.	The mains voltage is not input or too low.	◆ Check the power supply.
		The switching power supply on drive board of the AC Drive is faulty.	◆ Check bus voltage.
		Wires between control board and drive board and Between control board and operating panel break.	◆ Re-plug the 30-core cable
		Pre-charge resistor of the AC drive is damaged.	◆ Contact the agent

		Control board or operating panel is faulty.	
		Rectifier bridge is damaged.	
2	"510-H" is displayed while power-on	Wire between drive board and control board is in poor	◆ Re-plug the 30-core cable
		Related components on control board are damaged	◆ Contact the agent.
		The motor or motor cable is short circuited to ground.	
		The hall is damaged.	
		The mains voltage is too low.	
3	"FU23" is displayed at power-on.	Motor or motor output cable is short circuited to Ground.	◆ Use a megger to measure insulation resistance Of motor and motor cable.
		The AC drive is damaged.	◆ Contact the agent
4	The display is normal while power-on. But after running, "-510-H" is displayed and the drive stops Immediately.	The cooling fan is damaged or locked-rotor occurs.	◆ Replace the fan. ◆
		Short circuit exists in wiring of control terminals.	Eliminate short circuit fault in control circuit wiring.
5	FU14 (IGBT overheat) is detected frequently.	The setting of carrier frequency is too high.	◆ Reduce carrier frequency (P0-15).
		The cooling fan is damaged, or ventilation is clogged.	◆ Replace the fan or clean the ventilation.
		Components inside the AC drive are damaged (Thermistor or others).	◆ Contact the agent

No.	Error	Reason	Possible Solution
6	The motor does	Motor and motor wires	◆ Check that wiring between AC

	not rotate after the AC drive runs.		drive and motor is normal.
		Related AC drive and motor parameters Are set improperly.	Restore the factory parameters and re-set the following ◆ parameters properly: ◆ Encoder parameters ◆ Motor ratings, such as rated motor frequency and rated motor speed ◆ Motor 1 control mode (P0-01) and command source ◆ selection (P0-02) ◆ P3-01 (torque boost) in V/F control under heavy-load start.
		Cable connection between drive board And control board is in poor contact.	◆ Re-connect wirings and ensure secure connection.
		The drive board is faulty.	◆ Contact the agent
7	S terminals are disabled.	Related parameters are set incorrectly.	◆ Check and set parameters in group F4 again.
		External signals are incorrect.	◆ Re-connect external signal cables.
		Jumper across OP and +24 V becomes Loose.	◆ Re-confirm the jumper bar across OP and +24 V.
		The control board is faulty.	◆ Contact the agent.
8	Motor speed does not rise in FVC control.	Encoder is faulty.	◆ Replace encoder and re-confirm cable connection.
		Encoder connection is incorrect or in poor Contact.	◆ Replace the PG card.
		PG card is faulty.	◆ Contact the agent
		Drive board is faulty.	
9	The AC drive detects over current and over voltage Frequently.	Motor parameters are set improperly.	◆ Set motor parameters or perform motor auto-tuning again
		Acceleration/deceleration time is improper.	◆ Set proper acceleration/deceleration time.

		Load fluctuates.	◆ Contact the agent
10	FU17 is detected upon power-on or running.	The pre-charge relay or contactor is not Closed.	<ul style="list-style-type: none"> ◆ Check whether the relay or contactor cable is loose. ◆ Check whether the relay or contactor is faulty. ◆ Check whether 24 V power supply of the contactor is faulty. ◆ Contact the agent

EV510 Definition of Communication

Data Address

The drive supports four communication protocols (Modbus-RTU, CANopen, CANlink, and PROFIBUS-DP). The user programmable card and point-to-point communication are derivation of CANlink protocol.

Host computer can implement control such as monitoring and parameter viewing and modification on

The AC drive through their protocols.

The drive's communication data is classified into parameter data and non-parameter data. The nonparameter data includes running commands, running status, running parameters and alarm information.

I.1 DSI-200 Parameter Data

The parameter data provides important parameters of the AC drive.

DSI-200 have group P and Group A. The parameter data is described as below:

DSI-200. Parameter data	P group (read-write)	P0、 P1、 P2、 P3、 P4、 P5、 P6、 P7、 P8、 P9、 PA、 PB、 PC、 PD、 PE、 PF
	A group (read-write)	A0、 A1、 A2、 A3、 A4、 A5、 A6、 A7、 A8、 A9、 AA、 AB、 AC、 AD、 AE、 AF

Communication addresses of parameter data are defined as follows:

1. When parameter data is read by means of communication

For groups P0 to PF and A0 to AF, the high 16 bits of the communication address indicate the group number and the low 16 bits indicate the parameter number in the group.

Example:

Communication address of P0-16 is F010H, where F0H represents group P0 and 10H is the hexadecimal data format of serial number 16 in the group.

Communication address of AC-08 is AC08H, where ACH represents group AC and 08H is the hexadecimal data format of serial number 8 in the group.

2. When parameter data is written by means of communication

For groups P0 to PF, whether the high 16 bits in communication address are 00 to 0F or P0 to PF is decided by whether the high 16 bits are written to EEPROM. The low 16 bits indicate parameter number in the group.

Example:

P0-16: If it need not be written to EEPROM, communication address is 0010H. If it needs to be written to EEPROM, communication address is P010H.

For groups A0 to AF, whether the high 16 bits in communication address are 10 to 4F or A0 to AF is decided by whether the high 16 bits are written to EEPROM. The low 16 bits indicate Parameter number in the group.

AC-08: If it need not be written to EEPROM, communication address is 4C08H. If it needs to be written to EEPROM, communication address is AC08H.

I.2 Non-Parameter Data

DSI-200. Non-Parameter Data	Status data (read only)	Group d monitoring parameters, AC drive fault information and AC drive running status
	Control parameters (write-only)	Control commands, communication setting values, AO1 control, AO2 control, high-speed pulse (FMP) output control and parameter initialization

1. Status Data

Status data includes group d (monitoring parameters), AC drive fault description and AC drive running status.

- Group d (monitoring parameters)

The high 16 bits in communication address of d0 to dF is 70 to 7F and the low 16 bits indicate the function code number in the group. For example, the communication address of d0-11 is 700BH.

- AC drive fault description

When fault description is read via communication, the communication address is

8000H. you can obtain current fault code of the AC drive by reading the address.

- AC drive running status

When the drive running status is read via communication, the communication address is 3000H. You can obtain current running status information of the AC drive by reading the address. The running status is defined in the following table.

Communication Address of	Running Status Status Definition
--------------------------	----------------------------------

AC Drive's	
3000H	1: Forward run 2: Reverse run 3: Stop

2. Control Parameters

The control parameters include control command, communication setting values, AO1 control, AO2 control, high-speed pulse (FMP) output control and parameter initialization.

- Control commands

When P0-02 (command source selection) is set to 2 (serial comms.), you can

Implement control such as start/stop of the AC drive by using communication address.

The control commands are defined in the following table.

Communication Address of AC Drive's Running Status	Status Definition
2000H	1: Forward run 2: Reverse run 3: Forward jog 4: Reverse jog 5: Coast to stop 6: Decelerate to stop 7: Fault reset

Communication reference

Communication setting values include data set via communication such as frequency reference, torque limit, V/F separation voltage, PID reference and PID feedback. Communication address is 1000H. The range is -10000–10000 and corresponding value range is -100.00% to 100.00%.

- Digital output terminal control

When a Digital output terminal is set for function 20 (Communication setting), Control on DO terminals of the drive is defined in the following table.

Communication Address of Drive Running Status	Status Definition
2001H	Bit0 : non Bit1 : non Bit2 : RELAY1 output control Bit3 : RELAY2 output control Bit4 : HD1 output control

AO1 control, AO2 control, high-speed pulse (FMP) output control

When AO1, AO2 and FMP are set to function 12 (Communication setting), host computer can implement control on AO and high-speed pulse outputs by means of communication addresses. The definition is provided in the following table.

Communication Address		Command Definition
AO1	2002H	0 ~ 7FFF indicates 0% ~ 100%
AO2	2003H	

Parameter initialization

This function is required when you need to perform parameter initialization on the drive by using host computer.

If PP-00 (User password) is set to a non-zero value, pass password verification first. Host computer performs parameter initialization within 30s after password verification is successful.

Communication address of password verification via communication is 1F00H. Directly write correct user password to this address to perform password verification.

Communication address of parameter initialization by means of communication is 1F01H, defined in the following table.

Communication Address of Parameter Initialization	Command Definition
1F01H	1: Restore default settings 2: Clear records 4: Restore user backup parameters 501: Back up current user parameters

Modbus Communication Protocol

The drive provides RS485 communication interface and supports Modbus-RTU communication protocol so that the user can implement centralized control, such as setting running commands and function codes, and reading running status and fault information of the AC drive, by using a PC or PLC.

J.1 Agreement content

This protocol defines content and format of transmitted messages during serial communication, including master polling (or broadcasting) format and master coding method (function code for the action, transmission data, and error check). The slave uses the same structure in response, including action confirmation, data returning and error check. If an error occurs when the slave receives a message, or the slave cannot complete the action required by the master, the slave returns a fault message as a response to the master

Application

The AC drive is connected to a "single-master multi-slave" PC/PLC control network with RS485 Bus.

Bus Structure

(1) Topological structure

The system consists of a single master and multiple slaves. In the network, each communication device has a unique slave address.

A device is the master (can be a PC, a PLC or an HMI) and initiates communication to perform parameter read or write operations on slaves. The other devices (slaves) provide data to respond to query or operations from the master. At the same moment, either the master or the slave transmits data and the other can only receive data. The address range of the slaves is 1 to 247, and 0 is broadcast address. A slave address must be unique in the network.

(2)Transmission mode

The asynchronous serial and half-duplex transmission mode is used. During asynchronous serial communication, data is sent frame by frame in the form of message. In Modbus-RTD protocol, an interval of at least 3.5-byte time marks the end of the previous message. A new message starts to be sent after this interval.

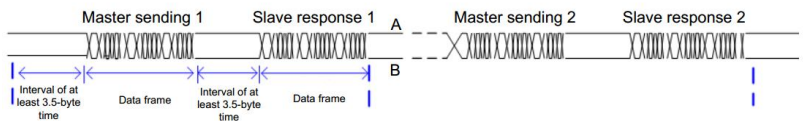

The communication protocol used by the drive is the Modbus-RTD slave communication protocol, which allows the drive to provide data to respond to "query/command" from the master or execute the action according to "query/command" from the master.

The master can be a PC, an industrial device, or a PLC. The master can communicate with a single slave or send broadcast messages to all slaves. When the master communicates with a single slave, the slave needs to return a message (response) to

"query/command" from the master. For a broadcast message sent by the master, the slaves need not return a response.

Data Format

The drive supports reading and writing of word-type parameters only. Reading command is 0x03 and writing command is 0x06. It does not support reading and writing of bytes or bits.

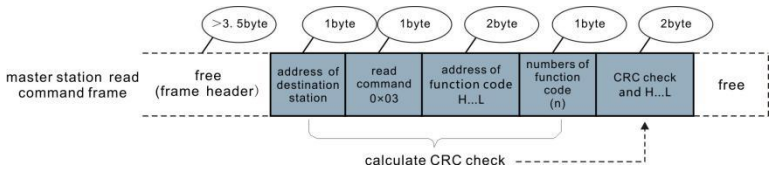

In theory, host computer can read several consecutive parameters (n can reach up to 12) but the last parameter it reads must not jump to the next parameter group. Otherwise, an error occurs on Response.

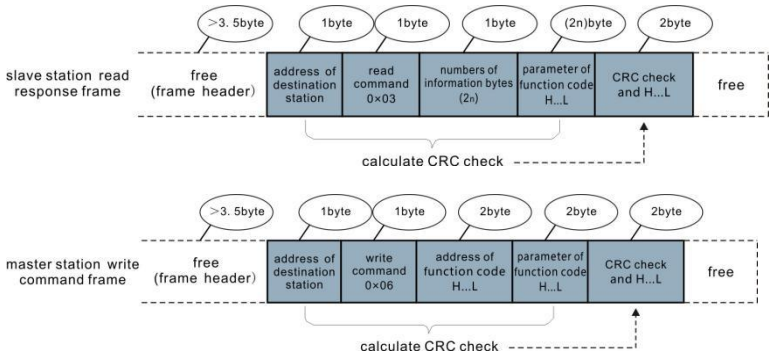

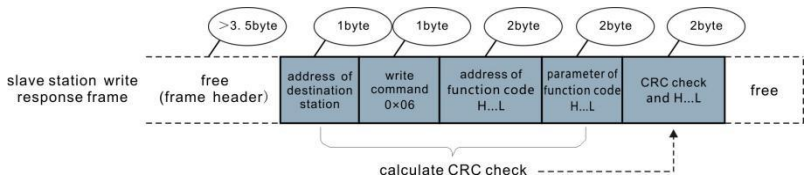

If the slave detects a communication frame error or reading/writing failure is caused by other reasons, an error frame will be returned as follows:

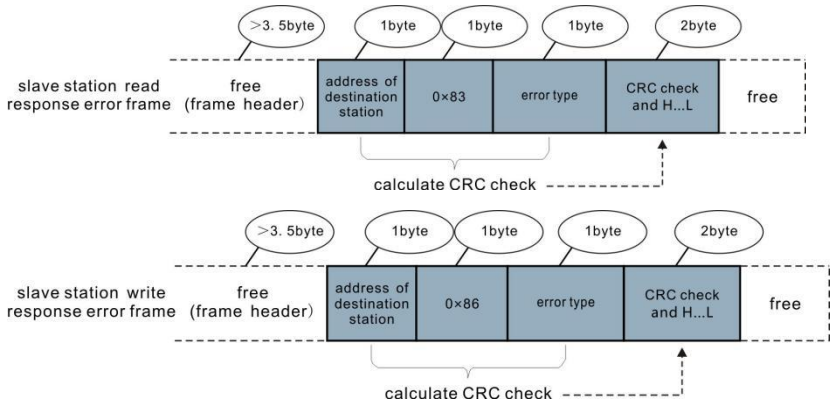

The frame format is described in the following table.

Frame header START	Greater than the 3.5-byte transmission idle time
Slave address (ADR)	Communication address : 1 to 247 0: Broadcast address
Command code (CMD)	03:Read slave parameters 06: Write slave parameters
Function code address H	It is the internal parameter address of the AC drive, expressed in hexadecimal format. The parameters include functional parameters and non-functional parameters (running status and running command). During transmission, low-order bytes follow the high-order bytes.
Function code address L	
Number of function codes H	It is the number of function codes read by this frame. If it is 1, it indicates that one function code is read. During transmission, low bytes follow high bytes. In the present protocol, only one function code is read once, an this field is unavailable.
Number of function codes L	
Data H	It is the response data or data to be written. During transmission, low-order bytes follow the high-order bytes.
Data L	
CRC CHK low bytes	It is the detection value (CRC16 verification value). During transmission, low-order bytes follow the high-order bytes.
CRC CHK high bytes	
END	3.5 byte transmission time.

CRC Check

In Modbus-CRC mode, a message includes a CRC-based error-check field. The CRC field checks content of entire message. The CRC field is two bytes, containing a 16-bit binary value. The CRC field is calculated by transmitting device, and then added to message. The receiving device recalculates a CRC value after receiving message, and compares the calculated value with the CRC value in the received CRC field.

The CRC is first stored to 0xFFFF. Then a procedure is invoked to process the successive 8-bit byte in the message and the value in the register. Only the eight bits in each character are used for the CRC. The start bit, stop bit and the parity bit do not apply to the CRC.

During generation of the CRC, each eight-bit character is in exclusive-OR (XOR) with the content in the register. Then the result is shifted in the direction of the least significant bit (LSB), with a zero filled into the most significant bit (MSB) position. The LSB is extracted and examined. If the LSB was a 1, the register then performs XOR with a preset value. If the LSB was a 0, no performed. This process is repeated until eight shifts have been performed. After the last (eighth) shift, the next eight-bit byte is in XOR with the register's current value, and the process repeats for eight more shifts as described above. The final value of the register, after all the bytes of the message have been applied, is the CRC value. The CRC is added to the message from the low-order byte followed by the high-order byte.

The CRC simple function is as follows: unsigned int crc_chek

```
value ( unsigned char *data value, unsigned char length ) {  
  
    unsigned int crc value=0xFFFF;  
  
    int i;  
  
    while ( length-- )  
        {  
            crc_value^=*data_value++;  
  
            for ( i=0;i<8;i++ )  
                {  
                    if ( crc_value&0x0001 )  
                        = ( crc_value>>1 )  
                    }  
                    else  
^0xa001;{  
                {  
                    }  
                }  
            }  
  
            crc_value=crc_value>>1;  
        }  
  
    return ( crc_value ) ;  
}
```

Definition of Communication Parameter Addresses

Read and Written Parameters Function parameters can be read and written (except those which cannot be changed because they are only for the factory use or for monitoring).

Parameter group No. and parameter identifying No. are used to express parameter address.

- High-order bytes: P0 to PF (groups P), A0 to AF (groups A), 70 to 7F (group d)
- Low-order bytes: 00 to FF

For example, to read parameter P3-12, communication address of F3-12 is expressed as 0xP30C

Note

- Group PF: The parameters cannot be read or changed.
- Group d: These parameters can only be read.

Some parameters cannot be modified when the AC drive is running. Some parameter cannot be modified regardless of status of the AC drive. In addition, pay attention to setting range, unit and description of parameters when modifying them.

Parameter Group	Visited Address	Parameter Address in RAM
P0 ~ PE Group	0xF000 ~ 0xFEFF	0x0000 ~ 0x0EFF
A0 ~ AC Group	0xA000 ~ 0xACFF	0x4000 ~ 0x4CFF
d0 Group	0x7000 ~ 0x70FF	

Notes: Frequent storage to the EEPROM reduces its service life.

Therefore, in communication mode, users can change values of certain parameters in RAM rather than storing the setting.

- For groups P parameters, users only need to change high order F of the function code address to 0. For groups A parameters, users only need to change high order A of the function code address to 4. The function code addresses are expressed as follows:

- High-order bytes: 00 to 0F (groups P), 40 to 4F (groups A)
- Low-order bytes: 00 to FF

For example, if function code P3-12 is not stored into EEPROM, the address is expressed

as 030C; if function code A0-05 is not stored into EEPROM, the address is expressed as 4005.

It is an invalid address when being read. Users can also use command code 07H to implement this function.

Stop/RUN Parameters

Para. Address	Description	Address	Description
1000	*Communication setting value (Decimal) -10000~10000	1010	PID setting
1001	Running frequency	1011	PID feedback
1002	Bus voltage	1012	PLC process
1003	Output voltage	1013	Pulse input frequency, unit: 0.01kHz

1004	Output current	1014	Feedback speed, unit: 0.1Hz
1005	Output power	1015	Remaining running time
1006	Output torque	1016	AI1 voltage before correction
1007	Running speed	1017	AI2 voltage before correction
1008	S input indication	1018	AI3 voltage before correction
1009	HDO output indication	1019	Linear speed
100A	AI1 voltage	101A	Current power-on time
100B	AI2 voltage	101B	Current running time
100C	AI3 voltage	101C	Pulse input frequency, unit 1Hz
100D	Counting value input	101D	Communication reference
100E	Length value input	101E	Actual feedback speed
100F	Load speed	101F	Main A frequency reference display
		1020	Auxiliary B frequency reference display

Notes :

Communication setting value indicates percentage: 10000 corresponds to 100.00%, and -10000 corresponds to -100.00%.

With regard to frequency, communication reference is a percentage of P0-10 (maximum frequency). With regard to torque, communication reference is a percentage of P2-10 and A2-48 (corresponding to motor 1 and motor 2, respectively).

Control command input to AC drive (write-only):

Command Word Address	Command Word Function
----------------------	-----------------------

2000	0001: Forward run 0002: Reverse run 0003: Forward jog 0004: Reverse jog 0005: Coast to stop 0006: Decelerate to stop 0007: Fault reset
------	--

Read AC drive state (read-only):

Command Word Address	Command Word function
3000	0001: Forward RUN 0002: Reverse RUN 0003: Stop

Parameter lock password check : (If "8888H" is returned, it indicates that password check is passed.)

Password address	Password Content
1F00	*****

DO terminal control (write-only)

Command Address	Command Content
2001	BIT2: RELAY1 control BIT3: RELAY2 control BIT4: HDO control

AO1 control (write-only)

Command Address	Command Content
2002	0 ~ 7FFF indicate 0% ~ 100%

AO2 control (write-only)

Command Address	Command Content
-----------------	-----------------

2003	0 ~ 7FFF indicate 0% ~ 100%
------	-----------------------------

Pulse output control (write-only)

Command Address	Command Content
2004	0 ~ 7FFF indicate 0% ~ 100%

AC drive fault description

AC Drive Fault Address	AC Drive Fault Information		
8000	0000: No fault	0014: Encoder/PG card fault	001D: Accumulative power-on time reached
	0001: Reserved		001B: User-defined fault 1
	0002:Over current during acceleration,	000D:Power output phase loss	001C: User-defined fault 2
	0003:Over current during deceleration	000E: IGBT overheat	001E: Load lost
	0004:Over current at constant speed	000F: External fault	001F: PID feedback lost during Running
	0005:Over voltage during	0010:Communication fault	0028: Fast current limit timeout
		0015:Parameter read and write fault	0029: Motor switch over error
		0016:AC drive hardware fault	
		0017: Motor short circuited to ground	

Group Pd Communication Parameter Description

Pd-00	Baud rate	Factory default	6005
	Set range	Bit : MODBUS Baud rate	
	0 : 300BPS	5 : 9600BPS	
	1 : 600BPS	6 : 19200BPS	
	2 : 1200BPS	7 : 38400BPS	
	3 : 2400BPS	8 : 57600BPS	

This parameter is used to set transmission speed between host computer and AC drive. Note that baud rate of host computer must be the same as that of AC drive. Otherwise, communication shall fail. The higher baud rate is, the faster communication will be.

Pd-01	Modbus Data	Factory default	0
	Set range	0: No check <8,N,2> 1: Even parity check <8,E,1> 2: Odd parity check <8,O,1> 3: No check, data format <8,N,1>	

Note that data format of host computer must be the same as that of AC drive. Otherwise, communication shall fail.

Pd-02	Local address	Factory default	1
	Set range	1~247 , 0 Broadcast address	

This parameter is used to set address of AC drive. This address is unique (except broadcast address), which is basis for point-to-point communication between host computer and AC drive. When

local address is set to 0 (that is, broadcast address), AC drive can only receive and execute broadcast commands of host computer, but will not respond to host computer.

Pd-03	Modbus Response delay	Factory default	2ms
	Set range	0~20ms	

This parameter sets interval between AC drive completing receiving data and AC drive sending data to host computer. If response delay is shorter than system processing time, system processing time shall prevail. If response delay is longer than system processing time, system sends data to host computer only after response delay is up.

Pd-04	Communication timeout	Factory default	0.0 s
	Set range	0.0 s (invalid) ; 0.1~60.0s	

When this parameter is set to 0.0s, system does not detect communication timeout

When AC drive does not receive communication signal within time set in this parameter, it detects communication timeout fault (FU16). . Generally, this parameter is set to 0.0s. In applications with continuous communication, you can use this parameter to monitor communication status.

Pd-05	Modbus protocol selection	Factory default	30
-------	---------------------------	-----------------	----

	Setting Range	Bit: MODBUS 0: Non-standard MODBUS protocol 1: Standard MODBUS protocol Ten: Profibus-DP 0: PPO1 format
--	---------------	---

Pd-05 = 1: Select the standard Modbus protocol.

Pd-05 = 0: When reading a command, the number of bytes returned by the slave is one byte greater than the standard Modbus protocol. Refer to the "5 Communication Data Structure" section of this protocol.

Pd-06	Communication read current resolution	Factory default	0
	Set range	0 : 0.01A ; 1 : 0.1A	

Used to determine the output unit of the current value when the communication reads the output current

Pentax DSI-200 Series Frequency Inverter



Viale dell'Industria, 1
37040 Veronella (VR) Italy
Tel. +39 0442 489 500
Fax +39 0442 489 510
www.pentax-pump.com
com@pentax-pumps.it



کیلومتر 10 جاده مخصوص کرج، روپروی رنگ هاویلوکس، پلاک 106
تلفن: 44566111
فاکس: 44566114
www.dieselsaz.com
Trading@dieselsaz.com