



**Flameproof motors**  
**Moteurs antidéflagrants**  
**Explosionssgeschützte Motoren**  
**Motores antideflagrantes**  
**Motori antideflagranti**

63 ÷ 315

II 2G, II 2GD

---

Ex d, Ex de • IIB, IIC • tD • IP65 (A21)

**cemp**

Flameproof  
Motors

Member of  
**ABG Group**

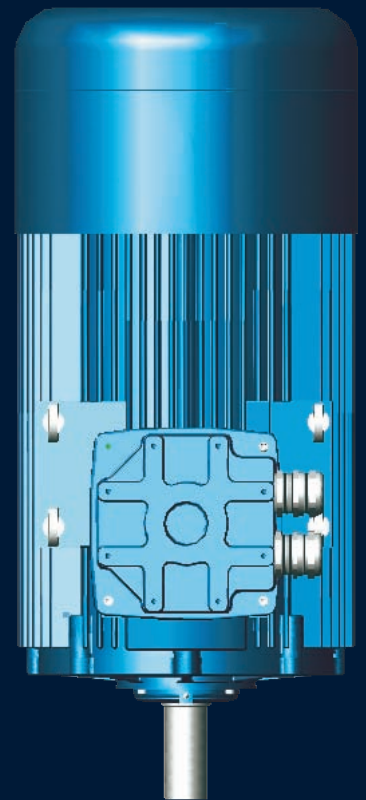



**Atav - Les Ateliers de l'Avre**

---

is a Cemp trademark

**cemp**

---

Flameproof  
Motors



**Flameproof motors**  
**Moteurs antidéflagrants**  
**Explosionssgeschützte Motoren**  
**Motores antideflagrantes**  
**Motori antideflagranti**

**63 ÷ 315**

**II 2G, II 2GD**

---

**Ex d, Ex de • IIB, IIC • tD • IP65 (A21)**

## GB CONTENTS

	Page		Page
<b>0. Introduction</b> .....	9	<b>3. Electrical design</b> .....	36
0.1 SI units and conversion equations .....	9	3.1 Standard operating conditions .....	36
0.2 Engineering formulae for motor drives .....	10	3.2 Efficiency and power factor at partial load .....	38
0.3 Standards and specifications .....	11	3.3 Insulation and temperature rise .....	39
0.4 Protection against explosions in dangerous areas .....	12	3.4 Duty types .....	40
<b>1. General informations</b> .....	20	3.5 Connecting diagrams .....	42
1.1 Range of motors in the ATEX series .....	20	3.6 Protection devices .....	45
1.2 Main characteristics .....	21	3.7 Frequency converter driven motors .....	46
1.3 Main options .....	22	<b>4. Performance data</b> .....	207
1.4 Nomenclature .....	23	4.1 Three-phase motors, 1 speed .....	208
<b>2. Design features</b> .....	24	4.2 Three-phase motors, 2 speeds, for general purpose (constant torque) .....	216
2.1 Mounting arrangements .....	24	4.3 Three-phase motors, 2 speeds, for centrifugal machines (quadratic torque) .....	224
2.2 Installation and applications .....	26	4.4 Single-phase motors .....	232
2.3 Materials, painting and nameplate .....	28	4.5 Motors energized by inverter .....	234
2.4 Shaft ends, balancing, vibrations, noise level coupling and belt drives .....	29	<b>5. Overall dimensions</b> .....	245
2.5 Bearing system .....	30	<b>6. Spare parts</b> .....	251
2.6 Terminal box .....	34		

## F SOMMAIRE

	Page		Page
<b>0. Introduction</b> .....	49	<b>3. Caractéristiques électriques</b> .....	76
0.1 Unités de mesure du SI et équivalences .....	49	3.1 Conditions nominales d'exploitation .....	76
0.2 Formules d'usage commun .....	50	3.2 Rendement et facteur de puissance à différentes charges .....	78
0.3 Normes et spécifications .....	51	3.3 Isolation et température d'échauffement .....	79
0.4 Protection contre les explosions dans les zones dangereuses .....	52	3.4 Différents régimes d'utilisation .....	80
<b>1. Informations générales</b> .....	60	3.5 Schémas de branchement .....	82
1.1 Gamme de moteurs de la série ATEX .....	60	3.6 Systèmes de protection .....	85
1.2 Caractéristiques principales .....	61	3.7 Moteurs alimentés par un variateur électronique de fréquence .....	86
1.3 Options principales .....	62	<b>4. Données nominales</b> .....	207
1.4 Identification de la référence commerciale .....	63	4.1 Moteurs triphasés, 1 vitesse .....	208
<b>2. Caractéristiques mécaniques</b> .....	64	4.2 Moteurs triphasés, 2 vitesses, pour usage général (couple constant) .....	216
2.1 Formes de construction .....	64	4.3 Moteurs triphasés, 2 vitesses, pour machines centrifuges (couple quadratique) .....	224
2.2 Installation et applications .....	66	4.4 Moteurs monophasés .....	232
2.3 Matériaux, peinture et plaque signalétique .....	68	4.5 Moteurs alimentés par variateur .....	234
2.4 Bout d'arbre, équilibrage, vibrations, bruit et accouplement .....	69	<b>5. Dimensions</b> .....	245
2.5 Roulements .....	70	<b>6. Pièces détachées</b> .....	251
2.6 Boîte à bornes .....	74		

## D INHALTSVERZEICHNIS

	Seite		Seite
<b>0. Einleitung</b> .....	89	<b>3. Elektrische Eigenschaften</b> .....	116
0.1 SI-Maßeinheiten und Umrechnungen .....	89	3.1 Nennbetriebsbedingungen .....	116
0.2 Formeln aus der Antriebstechnik .....	90	3.2 Wirkungsgrad und Leistungsfaktor bei Teillast .....	118
0.3 Normen und Spezifikationen .....	91	3.3 Isolierung und Übertemperatur .....	119
0.4 Explosionsschutz in den Gefahrenzonen .....	92	3.4 Betriebsarten .....	120
<b>1. Allgemeine Informationen</b> .....	100	3.5 Schaltung .....	122
1.1 Produktpalette der Motoren der Serie ATEX .....	100	3.6 Schutzvorrichtungen .....	125
1.2 Hauptmerkmale .....	101	3.7 Motoren für Antrieb durch elektronischen Frequenzwandler .....	126
1.3 Hauptausführungen .....	102	<b>4. Betriebsdaten</b> .....	207
1.4 Bedeutung der Kürzel .....	103	4.1 Drehstrom Motoren, 1 Drehzahl .....	208
<b>2. Mechanische Eigenschaften</b> .....	104	4.2 Drehstrom Motoren, 2 Drehzahlen, für allgemeinen Gebrauch (konstantes Gegenmoment) .....	216
2.1 Bauformen .....	104	4.3 Drehstrom Motoren, 2 Drehzahlen, für Zentrifugalmaschinen (quadratisches Gegenmoment) .....	224
2.2 Installation und Anwendungen .....	106	4.4 Einphasen Motoren .....	232
2.3 Material, Lackierung und Typenschild .....	108	4.5 Motoren mit Umrichter-versorgung .....	234
2.4 Wellenenden, Auswuchtung, Schwingungen, Geräuschpegel und Kupplung .....	109	<b>5. Abmessungen</b> .....	245
2.5 Lager .....	110	<b>6. Ersatzteilliste</b> .....	251
2.6 Klemmkasten .....	114		

# Flameproof motors

**GB**

# 0. Introduction

## 0.1 SI units and conversion equations

### 0.1 SI units and conversion equations

Table 0 A

Description	SI			Conversion equations
	Formular symbols	Unit symbol	Unit name	
Distance Area Volume	$L$ $A$ $V$	m $m^2$ $m^3$	metre	$1 m^3 = 1000 dm^3$ $1 dm^3 = 1 l$
Angle in one plane	$\alpha, \beta, \gamma$	rad	radian	$1^\circ = \frac{\pi}{180} \text{ rad}$ $1' = 1^\circ/60$ $1'' = 1'/60$
Time Frequency	$t$ $f$	s Hz	second Hertz	$1 \text{ Hz} = 1/s$
Speed Velocity Angular velocity	$n$ $v$ $\omega$	1/min m/s rad/s		$1 \text{ km/h} = \frac{1}{3.6} \text{ m/s}$
Acceleration Angular acceleration	$a$ $\alpha$	$m/s^2$ rad/s <sup>2</sup>		
Mass Density	$m$ $\rho$	kg kg/m <sup>3</sup>	kilogram	
Force Pressure Mechanical stress	$F$ $p$ $\sigma$	N  Pa = N/m <sup>2</sup> N/mm <sup>2</sup>	Newton  Pascal	$1 \text{ N} = 1 \text{ kg} \cdot 1 \text{ m/s}^2$ $9.81 \text{ N} = 1 \text{ kp}$ $9.81 \cdot 10^4 \text{ N/m}^2 = 1 \text{ kp/cm}^2$ $9.81 \text{ N/mm}^2 = 1 \text{ kp/mm}^2$
Work done Energy Thermal quantity	$W$ $W$ $Q$	$J = Nm$	Joule	$9.81 \text{ Nm} = 1 \text{ kpm}$ $4187 \text{ J} = 1 \text{ kcal}$ $1 \text{ kWh} = 3.6 \times 10^6 \text{ J}$
Torque	$M$	Nm		$9.81 \text{ Nm} = 1 \text{ kpm}$ $1 \text{ Nm} = 0.102 \text{ kpm}$
Power	$P$	$W = J/s = Nm/s$	Watt	$735.5 \text{ W} = 1 \text{ hp}$
Moment of inertia	$J$	kg m <sup>2</sup>		$9.81 \text{ kg m}^2 = 1 \text{ kpms}^2$ $PD^2 = 4 \text{ J}$
Dynamic viscosity Kinematic viscosity	$\eta$ $\nu$	Pa · s m <sup>2</sup> /s		$10^{-1} \text{ Pa} \cdot \text{s} = 1 \text{ P (Poise)}$ $10^{-4} \text{ m}^2/\text{s} = 1 \text{ St (Stoke)}$
Electric current Electric voltage Electric resistance Electric conductivity Electric capacity Charge	$I$ $U$ $R$ $G$ $C$ $Q$	A V $\Omega$ S F C	Ampere Volt Ohm Siemens Faraday Coulomb	$1 \text{ A} = 1 \text{ W/V} = 1 \text{ V}/\Omega$ $1 \text{ V} = 1 \text{ W/A}$ $1 \Omega = 1 \text{ V/A} = 1/\text{S}$ $1 \text{ S} = 1/\Omega$ $1 \text{ F} = 1 \text{ C/V}$ $1 \text{ C} = 1 \text{ A} \cdot \text{s}$
Inductance Magnetic flux density Magnetic field strength Magnetic flux	$L$ $B$ $H$ $\Phi$	H T A/m Wb	Henry Tesla  Weber	$1 \text{ H} = 1 \text{ Vs/A}$ $1 \text{ T} = 1 \text{ Wb/m}^2$ $1 \text{ Wb} = 1 \text{ V} \cdot \text{s}$
Temperature difference	$T$ $\vartheta$	K °C	Kelvin	$0 \text{ K} = -273.15 \text{ }^\circ\text{C}$

## 0.2 Engineering formulae for motor drives

### 0.2 Engineering formulae for motor drives

#### Power (3-phase motors)

$$P_1 = \text{power input} = \frac{U \cdot I \cdot \cos \varphi \cdot \sqrt{3} \cdot 10^{-3}}{\eta} \text{ [kW]}$$

$$P_2 = \text{power output} = P_1 \cdot \eta \text{ [kW]}$$

Where:

$$U = \text{voltage [V]}$$

$$I = \text{current [A]}$$

$$\cos \varphi = \text{power factor}$$

$$\eta = \text{efficiency}$$

#### Power requirements of some applications

Lifting:

$$P = \frac{m \cdot v}{\eta} \cdot 9.81 \cdot 10^{-3} \text{ [kW]}$$

Rotation:

$$P = \frac{M \cdot n}{9550 \cdot \eta} \text{ [kW]}$$

Fan and pump drives:

$$P = \frac{H \cdot Q}{\eta} \text{ [W]}$$

Where:

$$P = \text{power [kW]}$$

$$m = \text{mass [kg]}$$

$$v = \text{speed [m/s]}$$

$$n = \text{rotational speed [min}^{-1}\text{]}$$

$$\eta = \text{efficiency}$$

$$M = \text{torque [Nm]}$$

$$Q = \text{output [m}^3\text{/s]}$$

$$H = \text{head [N/m}^2\text{]}$$

#### Torque from motor power

$$M = 9550 \cdot \frac{P_2}{n} \text{ [Nm]}$$

Where:

$$P_2 = \text{motor output [kW]}$$

$$n = \text{motor speed}$$

Conversion of torque for step-up and step-down speed ratios:

$$M_2 = \frac{M_1 \cdot n_1}{n_2}$$

Where:

$$n_1 = \text{motor speed [min}^{-1}\text{]}$$

$$M_1 = \text{motor torque at } n_1 \text{ [Nm]}$$

$$n_2 = \text{speed of load [min}^{-1}\text{]}$$

$$M_2 = \text{torque of load at } n_2 \text{ [Nm]}$$

#### Moment of Inertia J

Moment of Inertia of a cylindrical flywheel:

$$J = \frac{md^2}{8}$$

Where:

$$m = \text{mass [kg]}$$

$$d = \text{flywheel diameter [m]}$$

Effective moment of inertia on the motor of a linearly moved load:

$$J = 91.2 \cdot m \cdot \left(\frac{v}{n}\right)^2$$

Where:

$$m = \text{mass [kg]}$$

$$v = \text{velocity [m/s]}$$

$$n = \text{motor speed [min}^{-1}\text{]}$$

Conversions of moments of inertia for step-up or step-down speed ratio:

$$J_2 = J_1 \cdot \left(\frac{n_1}{n_2}\right)^2$$

Where:

$$n_1 = \text{motor speed}$$

$$J_1 = \text{moment of inertia at } n_1$$

$$n_2 = \text{speed of load}$$

$$J_2 = \text{moment of inertia of load}$$

#### Factor of Inertia FI

$$FI = \frac{J_{\text{mot}} + J_{\text{load}}}{J_{\text{mot}}}$$

Where:

$$J_{\text{mot}} = \text{moment of inertia of motor}$$

$$J_{\text{load}} = \text{moment of inertia of load}$$

#### Starting time $t_a$

$$t_a = \frac{FI \cdot J_{\text{mot}} \cdot n}{9.55 \cdot (M_{\text{mot}} - M_{\text{load}})} \text{ [s]}$$

Where:

$$FI = \text{Factor of inertia}$$

$$J_{\text{mot}} = \text{moment of inertia of motor [kgm}^2\text{]}$$

$$n = \text{motor speed [min}^{-1}\text{]}$$

$$M_{\text{mot}} = \text{motor torque}$$

$$\text{during starting (mean) [Nm]}$$

$$M_{\text{load}} = \text{counter torque of load}$$

$$\text{during starting (mean) [Nm]}$$

#### Speed

The no-load speed is virtually the same as the synchronous speed. The synchronous speed of the motor is calculated as follow:

$$n_s = 120 \cdot f/p \text{ [min}^{-1}\text{]}$$

Where:

$$f = \text{frequency [Hz]}$$

$$p = \text{number of pole}$$

The synchronous speed is reduced by the slip (S) to the rated speed:

$$n_n = n_s \cdot (1-S) \text{ [min}^{-1}\text{]}$$

## 0.3 Standards and specifications

### 0.3 Standards and specifications

Flameproof motors conform to the following standards and specifications:

**Table 0 B**

Title	INTERNATIONAL	EU
	IEC	GENELEC
Electrical rotating machines/rated operation and characteristic data	IEC 60034-1	EN 60034-1
Methods for determining losses and efficiency of rotating electrical machines	IEC 60034-2	EN 60034-2
Protection types rotating electrical machines	IEC 60034-5	EN 60034-5
Cooling methods of rotating electrical machines	IEC 60034-6	EN 60034-6
Construction types of rotating electrical machines	IEC 60034-7	EN 60034-7
Terminal markings and direction of rotation for electrical machines	IEC 60034-8	HD 53 8
Noise emission, limit values	IEC 60034-9	EN 60034-9
Start-up behaviour of squirrel-cage motors at 50 Hz up to 660V	IEC 60034-12	EN 60034-12
Vibration severity of rotating electrical machines	IEC 60034-14	EN 60034-14
Protection level provided by enclosures for electrical equipment against mechanical impact (Code IK)	IEC 60068-1 IEC 60068-2-75	EN 50102
Fixing dimensions and outputs for IM B3	IEC 60072	EN 50347
Fixing dimensions and outputs for IM B5, IM B14	IEC 60072	EN 50347
Cylindrical shaft ends for electrical machines	IEC 60072	EN 60072
Electrical equipment for hazardous areas General provisions	IEC 60079-0	EN 60079-0
Electrical equipment for hazardous areas Flame-proof enclosure "d"	IEC 60079-1	EN 60079-1
Electrical equipment for hazardous areas Increased safety "e"	IEC 60079-7	EN 60079-7
Electrical equipment for use in areas with presence of combustible dust General provisions	IEC 61241-0	EN 61241-0
Electrical equipment for use in areas with presence of combustible dust Protection method "tD"	IEC 61241-1	EN 61241-1



## 0.4 Protection against explosions in dangerous areas

### 0.4.1 Types protection

#### 0.4.1 Types protection

The use of electrical apparatus in potentially explosive atmospheres is quite usual today.

This equipment has to be manufactured in such a way that there is no risk of explosion.

An explosion occurs when the three following conditions happen:

- presence of a potentially explosive atmosphere;
- possibility of transmission of the explosion;
- existence of an ignition source.

The recognized types of protection eliminate one of these conditions and thus make an explosion impossible.

Two types of protection prevent the presence of a potentially explosive atmosphere inside the electrical apparatus:

- oil immersion (safety "o");
- pressurized apparatus (safety "p").

Two types of protection make the transmission of an internal explosion to the potentially explosive atmosphere surrounding the electrical apparatus impossible:

- sand filling (safety "q");
- flameproof enclosure (safety "d").

Lastly, three types of protection eliminate any source of ignition such as sparks, overheating, etc...:

- increased safety (safety "e");
- intrinsic safety (safety "i");
- protection "n" (restricted to zone 2).

In practice, only four of these seven types of protection are applicable to electric motors:

- pressurized apparatus (symbol Ex p);
- flameproof enclosure (symbol Ex d);
- increased safety (symbol Ex e);
- non sparking protection (symbol Ex n).

**Electric motors have an additional type of protection (symbol Ex de) which is a combination of:**

- flameproof enclosure "d" for motor frame;
- increased safety "e" for terminal box.



**Fig. 0 A** - Specific marking for protection against explosions - Directive 94/9/EC.

## 0.4

### 0.4.2 Dangerous areas and zones

#### 0.4.2 Dangerous areas and zones

Dangerous areas include any area in which explosive atmospheres may occur under specific conditions.

An explosive atmosphere is a mixture of air and combustible gases, vapours, fumes or dust under atmospheric conditions where combustion expands itself (explosion) after ignition.

Only local authorities can classify hazardous areas.

The user shall classify the hazardous areas as indicated in the European directive 1999/92/EC under his own responsibility.

International standards IEC 61241-10 provide instructions on how to classify the hazardous areas in relation to the chemical nature, to the physical characteristics and to the amount of substances used and based on the frequency and period of time in which an explosive mix may develop.



**Fig. 0 B** - Warning sign for areas subject to the risk of explosion - Directive 99/92/EC

#### Zones susceptible to gas

When the hazard is due to the presence of gas, vapours or mists of flammable substances, the European directive 1999/92/EC envisages a classification in three zones defined as follows:

**Zone 0** - Areas constantly susceptible to an explosive atmosphere, or for long periods of time. Power equipment with double insulation must be installed in this area.

**Zone 1** - Areas where an explosive atmosphere is likely to develop during normal conditions. Flameproof electric motors or motors with added protection means can be installed in this zone (for the latter, restrictions by the standards apply).

**Zone 2** - Areas rarely susceptible to an explosive atmosphere and for a short period of time. Flameproof motors or motors with added protection can be installed in this zone, as well as non-sparking motors.

#### Zones susceptible to combustible dust

When the hazard is due to the presence of combustible dust, the European directive 1999/92/EC envisages a classification in three zones defined as follows:

**Zone 20** - Areas constantly susceptible to an explosive atmosphere, or for long periods of time. Power apparatus cannot be installed in this zone.

**Zone 21** - Areas where an explosive atmosphere is likely to develop during normal conditions. Electric motors certified in compliance with the ATEX directive with IP6X protection rating can be installed in this zone

**Zone 22** - Areas rarely susceptible to an explosive atmosphere, and only for a short period of time. In the presence of conductive dust, electric motors certified in compliance with the ATEX directive with protection rating IP6x can be installed in this zone, whereas in the presence of non conductive dust, motors with protection rating IP5x and a declaration of conformity issued by the manufacturer can be installed.

GB

**Table 0 C** - Dangerous areas classified into zones

Usage area in the presence of <b>GAS</b>	Usage area in the presence of <b>COMBUSTIBLE DUSTS</b>	Hazardous level of the operational <b>ZONE</b>
<b>Zone 0</b>	<b>Zone 20</b>	Explosive atmosphere <b>ALWAYS PRESENT</b>
<b>Zone 1</b>	<b>Zone 21</b>	<b>PROBABLE</b> explosive atmosphere
<b>Zone 2</b>	<b>Zone 22</b>	Explosive atmosphere <b>UNLIKELY</b>

## 0.4

### 0.4.3 Apparatus classification

#### 0.4.4 Enclosure groups

### 0.4.3 Apparatus classification

---

The ATEX 94/9/EC European Directive classifies equipment into three categories, with differing protection levels, related to the protection guaranteed.

**Table 0 D** - Equipment categories

PROTECTION LEVEL guaranteed by the equipment Category	MINE	SURFACE	
	Category	GAS Category	COMBUSTIBLE DUST Category
Very high	M1	1G	1D
High	M2	2G	2D
Normal	not provided for	3G	3D

NOTE: Equipment of higher categories can also be installed instead of those of a lower category.

### 0.4.4 Enclosure groups

---

The standards classify electrical equipment into two groups.

Group I: electric apparatus to be installed in mines or galleries susceptible to firedamp or coal dust.

Group II: electric apparatus to be installed in surface plants susceptible to other explosive atmospheres.

The enclosures for equipment intended for use on the surface, providing “d” protection (flameproof), are in turn broken down into three sub-groups, in relation to the inflammable substances for which they are suitable:

Group IIA, Group IIB, Group IIC.

A motor that belongs to a certain enclosure group is also suitable for lower enclosure groups: a motor in group IIB is also suitable for group IIA; a motor in group IIC is also suitable for group IIA and IIB.

## 0.4

### 0.4.5 Temperature classes (for gas atmospheres)

#### 0.4.5 Temperature classes (for gas atmospheres)

The electrical apparatus is classified into 6 classes according to the maximum surface temperatures.

The maximum surface temperature is the highest temperature which is attained in service under the conditions described in the standards, by any part of the electrical apparatus, which, could ignite the surrounding atmosphere.

For electric motors this is:

- the temperature of the outside surface of the enclosure for “d” and “p” protection modes;
- the temperature of any internal or external point for type of protection “e” or “n”.

GB

Table 0 E

Ignition temperature of medium relative to limit temperature [°C]	Temperature class	Maximum surface temperature of electrical equipment including 40 °C ambient temperature	
		[°C]	[°F]
over 450	<b>T 1</b>	450	842
from 300 to 450	<b>T 2</b>	300	572
from 200 to 300	<b>T 3</b>	200	392
from 135 to 200	<b>T 4</b>	135	275
from 100 to 135	<b>T 5</b>	100	212
from 85 to 100	<b>T 6</b>	85	185

## 0.4

### 0.4.6 Combustion temperatures of gases, vapours and groups

#### 0.4.6 Combustion temperatures of gases, vapours and groups

Combustible gases and vapours are divided into classes according to their ignition temperature and into groups according to their explosive capacity.

Markings on motors and other electrical equipment with the symbols used to indicate the protection mode, the enclosure group, and the temperature class, indicate the zone in which such equipment can be installed.

GB

**Table 0 F** - Classification of the more common combustible gases and vapours according to temperature class and group

Group	Temperature classes					
	T 1	T 2	T 3	T 4	T 5	T 6
<b>I</b>	Methane (firedamp)					
<b>IIA</b>	Acetic acid Acetone Ammonia Benzole Benzene Butanone Carbon monoxide Ethane Ethyl acetate Ethyl Chloride Methane Methanol Methyl acetate Methyl alcohol Methyl Chloride Naphtalene Propane Toluene Xylene	Acetic anhydride I amyl acetate n butane n butyl alcohol Amylic alcohol Butyl acetate Cyclohexanon Ethyl alcohol Iso butylic alcohol Liquefied gas Natural gas Propyl acetate	Cyclohexane Cyclohexanol Decane Diesel fuels Gasoline Heating oil Heptane Hexane Jet fuels Pentane Petroleum*	Acetaldehyde Ether		
<b>IIB</b>	Coke-oven gas Water gas (carburetted)	1,3- butadiene Ethylene Ethylbenzene Ethylene oxide	Hydrogen sulphide Isoprene Petroleum*	Ethyl ether		
<b>IIC</b>	Hydrogen	Acetylene				Carbon disulphide Ethyl nitrate

\* depending on composition

## 0.4

### 0.4.7 Temperature for atmospheres with combustible dusts

#### 0.4.7 Temperature for atmospheres with combustible dusts

The flash point of the dust must be taken into account in providing protection against flammable dust, both where this is in cloud form and in layers.

The surface temperature of the enclosure indicated on the motor nameplate must be less than the reference ignition temperature.

The reference temperature is the lowest between the two values thus calculated:

$TS1 = 2/3 T_{cl}$  ( $T_{cl}$  = ignition temperature of the cloud of dust)

$TS2 = T_{5mm} - 75K$  ( $T_{5mm}$  = ignition temperature of a 5mm layer of dust).

$T_{amm}$  = lowest between  $TS1$  and  $TS2$ .

GB

**Table 0 G** - Calculation of the flash points for combustible dusts

Dust ignition temperature	Cloud $T_{cl}$	Layer $T_{5mm}$
↓		
Safety temperature	$T_{s1} = 2/3 T_{cl}$	$T_{s2} = T_{5mm} - 75K$
↓		
Maximum surface temperature	$T_{amm}$ = lowest between $T_{s1}$ and $T_{s2}$	
↓		
Surface temperature of the motor $\leq T_{amm}$		

**Table 0 H** - Examples of flash points for combustible dusts

	Cloud [°C]	Layer [°C]
Aluminium	590	>450
Carbon dust	380	225
Flour	490	340
Wheat dust	510	300
Methylcellulose	420	320
Phenolic resin	530	>450
Polyethylene	420	melting
PVC	700	>450
Soot	810	570
Starch	460	435
Sugar	490	460

Source SIRA Ltd

## 0.4

### 0.4.8 Choice of safety-electric motor

#### 0.4.8 Choice of safety-electric motor

The connection between danger zones and the categories of equipment to be used is defined in Directive 1999/92/EC.

The specific construction standards for the protection modes (e.g. Ex d) also define the motor category that can be obtained by applying the standards (e.g. 2G).

GB

**Table 0 I** - Choosing the protection mode for zones in which gas is present

Explosive Atmosphere	Danger Zone	Protection guaranteed by Equipment	Motor Category	Protection Mode
ALWAYS PRESENT	0	Very High	1G	IEC EN 60079-26
PROBABLE	1	High	2G	Ex d Ex de Ex e
IMPROBABLE	2	Normal	3G	Ex nA

**Table 0 L** - Choice of protection mode for areas where combustible dust is present

Explosive Atmosphere	Danger Zone	Protection guaranteed by Equipment	Motor Category	Protection Mode
ALWAYS PRESENT	20	Very High	1D	Currently not provided for
PROBABLE	21	High	2D	Ex tD - A21 - IP6x
IMPROBABLE	22 Conductive dusts	Normal	2D	Ex tD - A21 - IP6x
IMPROBABLE	22 Non-conductive dusts	Normal	3D	Ex tD - A22 - IP5x

N. B. Equipment of a higher category can be installed in place of equipment of a lower category

## 0.4

### 0.4.9 Certification and approved laboratories

#### 0.4.9 Certification and approved laboratories

The motors offered in the catalogue herein comply with Directive 94/9/EC ATEX, which states that two different certificates of conformity are to be issued:

- EC Type examination certificate
- Product quality assurance notification.

##### Certification

Flameproof motors and motors with added protection must be approved by a notified body appointed by the European Commission according to the methods defined by the same ATEX directive.

The motors are classified based on the hazardous atmosphere of the place of installation.

The type of motor protection must be chosen on the basis of the area of installation.

The dangerousness of the zone is determined by the atmosphere involved.

The user is responsible for determining the type of protection, enclosure group, and maximum surface temperature of the motor to be installed.

The user must also correctly install, connect to the mains, use and service the motor. Certificates of conformity to CENELEC standards are valid in all member countries in the European Union and member countries of CENELEC.

The electro-technical committees of the following countries are members of the CENELEC: Austria, Belgium, Denmark, Finland, France, Germany, Greece, Ireland, Italy, Luxembourg, Norway, Holland, Portugal, United Kingdom, Spain, Sweden and Switzerland.

The nominal characteristics of motors relate to a maximum ambient temperature of 40°C.

The certifications are valid for a maximum ambient temperature of 60°C (IIC) and 80°C (IIB).

At ambient temperatures exceeding 40°C, the nominal characteristics may deviate from the standard.

Certificates of EC Type Conformity relate to motors with:

- IIB or IIC enclosure groups
- Ex d or Ex de protection modes
- category 2G and temperature classes T3, T4, T5, T6
- category 2GD and surface temperatures T150°C, T135°C, T100°C, T85°C.

These certificates cover:

- motors with voltage up to 1000V and frequencies of 50 and 60Hz
- single-phase motors
- three-phase double winding and/or double polarity motors
- motors installed at altitudes higher than 1000m above sea level
- service from S1 to S9
- motors operated by electronic frequency converter and with forced ventilation.
- accessories such as: anti-condensation heaters and temperature detectors
- ambient temperature:
  - minimum - 50 °C
  - maximum + 80 °C (T3)
  - + 60 °C (T4).

##### Notified bodies

The list of notified bodies can be found on the European Union website at the following address:  
[www.europa.eu.int/comm/enterprise/atex/nb/nblist.htm](http://www.europa.eu.int/comm/enterprise/atex/nb/nblist.htm)

##### IECEX Certifications

Presently (July 2008) the procedure for obtaining certifications according to the IECEX program is in place.



# 1. General informations

## 1.1 Range of motors in the ATEX series

### 1.1 Range of motors in the ATEX series

The motors offered in this catalogue comply with standards concerning equipment and protective systems intended for use in potentially explosive atmospheres, in compliance with European Directive 94/9/EC dated 23/3/94, otherwise known as the ATEX directive.

The ATEX directive states that two different certificates of conformity are to be issued.

One is the "EC-Type examination certificate" for the homologation of the prototype and the other is for the "Production Quality Assurance Notification".

The Certificates are issued by CESI in Milan, Notified Body no. 0722.

All motors in the ATEX series are available in 2G (for gas) or 2GD (for gas and dust) versions.

GB

**Table 1 A** - The Series ATEX range

Version	Frame size [mm]	Output range (2 pole) [kW]	Standard temperature class for 2G motors	Standard surface temperature for 2GD motors	Motor type			
					Ex d IIB	Ex de IIB	Ex d IIC	Ex de IIC
Single speed, three phase (2, 4, 6, 8 pole)	63 ÷ 315	0.18 ÷ 200.00	T4	T 135°C	<b>AB 30</b>	<b>AB 35</b>	<b>AC 30</b>	<b>AC 35</b>
Two speeds, three phase (2/4, 4/8, 4/6, 6/8 pole) for general purpose (constant-torque)	63 ÷ 315	0.15 ÷ 160.00	T4	T 135°C	<b>AB 20</b>	<b>AB 25</b>	<b>AC 20</b>	<b>AC 25</b>
Two speeds, three phase (2/4, 4/8, 4/6, 6/8 pole) for centrifugal machines (quadratic-torque)	63 ÷ 315	0.18 ÷ 160.00	T4	T 135°C	<b>AB 40</b>	<b>AB 45</b>	<b>AC 40</b>	<b>AC 45</b>
Single phase, (2, 4, 6 pole)	63 ÷ 100	0.10 ÷ 3.00	T4	T 135°C	<b>AB 10</b>	<b>AB 15</b>	<b>AC 10</b>	<b>AC 15</b>
Single-phase with capacitor in extra-size terminal box (2, 4, 6 pole)	63 ÷ 100	0.10 ÷ 1.10	T4	T 135°C	<b>AB 12</b>		<b>AC 12</b>	
Motors energized by inverter (2, 4, 6, 8 poli)	63 ÷ 315	0.18 ÷ 200.00	T4	T 135°C	<b>AB 70</b>	<b>AB 75</b>	<b>AC 70</b>	<b>AC 75</b>

**Table 1 B** - Temperature Class upon request

Version	T3	T5	T6
<b>63 ÷ 160</b>	Same power as T4	Same power as T4 (*)	Power lower than T4
<b>180 ÷ 315</b>	Same power as T4	Power lower than T4	Power lower than T4

(\*) For the single and three-phase, 2-speed motors: power lower than T4.

Also available flameproof motors with brake and flameproof motors of Group I for installation in mines. Documentation supplied upon request.

## 1.2 Main characteristics

### 1.2 Main characteristics

---

- Flameproof motors compliant with the Standards IEC EN 60079-0, 60079-1, 60079-7 for atmospheres where gas is present and IEC EN 61241-0, 61241-1 for areas where combustible dust is present.
- Three phase and single phase Squirrel Cage Asynchronous Induction motors.
- Totally enclosed, fan cooled, frame IP55 with Terminal box IP65.
- The motors dimensions comply with IEC 60072 standard.
- Power Supply 400V / 50Hz. Three-phase, 1-speed motors, 2-4-6-8 poles, T4 (for sizes between 63 and 250, multi-voltage power supply 380-400-420V/ 50 Hz).
- Class F insulation.
- Noise level within 80 dB (A).
- Terminal Box:
  - available both in a flameproof, or increased safety version
  - large size
  - standard position - top, opposite feet
  - rotate by 90° in 4 positions.
- Motor frame and terminal box enclosure separated to avoid the transmission of explosions.
- Winding cables connected to the terminal board by means of terminal blocks or by a flameproof sealing device.
- Internal and external mechanical components painted with epoxy polyester powders;
  - stainless steel nameplate,
  - anti-corrosion screws.
- Highly resistant to impact:
  - frame, terminal box and cast iron endshields.
  - fan cover in sheet steel.
- Low friction dust seals.
- The conformity certificates also cover alternatives, such as:
  - altitude over 1000m
  - modification of the rated voltage and rated frequency
  - power supply from an inverter
  - motor protection through temperature detectors
  - duty S1 to S9.

## 1.3 Main options

### 1.3 Main options

---

#### Main versions

- Motors with brakes.
- 2GD motors for areas classified as zone 21 and zone 22 (Combustible dusts).
- Group I motors (for mines).

#### Electrical variants

- Non-standard voltages and frequencies (maximum voltage 1000V).
- Motors for tropical climates.
- Motors for low temperatures (-50°C)
- Temperature rise below 80K.
- Motors insulated to class H.
- Motors with bimetallic detector, thermistor PTC or thermistor PT100.
- Motors with anti-condensation heaters.
- Motors with special electrical design.
- Single-phase motors with capacitor fitted in a large-size terminal box (Ex d, max 50 µF).

#### Mechanical variants

- Special flanges and shafts.
- Double ended shafts.
- Cable gland fitted to terminal box.
- Terminal box with special cable entries.
- Motors without terminal box and with loose cables. Sealing joints and conduits can be supplied on request.
- Motors protection IP56 - IP65 - IP66.
- Motors with condensation drainage valves.
- Motors with special bearings (uni-directional, with sensors, with rollers, insulated, oversized, thrust bearings).
- Grade A or B balancing
- Motors with a rain cap or sun shield, water-shedding disc.
- Side terminal box, 180 to 315M high (excluding 250)
- Separate terminal box for auxiliary terminals.
- Low noise emission version.
- High protection against corrosion for tropical climates or applications in marine environments:
  - external mechanical components finished with epoxy paint;
  - protection of the internal parts (winding and rotor) with protective paint;
  - stainless steel screws.

#### Accessories

- Motors suitable for frequency inverter drive.
- Motors with encoder.
- Motors with forced ventilation (from frame size 100).

#### Certificates

- Motors according to American Bureau of Shipping, Bureau Veritas, Det Norske Veritas, Germanischer Lloyd, Korean Register of Shipping, Lloyd Register of Shipping, Nippon Kaiji Kyokai, R.I.Na., ...

# 1.4 Nomenclature

## 1.4 Nomenclature

Pos. 1 = Motor series:

<b>A</b>	Flameproof 63÷315
----------	-------------------

Pos. 2 = Type of application:

<b>B</b>	Enclosure group IIB
<b>C</b>	Enclosure group IIC

Pos. 3 = Type of motor (electric characteristics):

<b>1</b>	Single phase	<b>4</b>	Three-phase 2 speed quadratic torque
<b>2</b>	Three-phase 2 speed, constant torque	<b>5</b>	For lifting
<b>3</b>	Three-phase 1 speed	<b>7</b>	For inverters

Pos. 4 = Terminal box version:

<b>0</b>	Protection method Ex d	<b>5</b>	Protection method Ex e
<b>3</b>	Without box, with plate Ex d	<b>2</b>	Ex d capacitor holder in extra-size box

Pos. 5 = Size (centre height):

<b>63</b>	<b>90</b>	<b>132</b>	<b>200</b>	<b>280</b>
<b>71</b>	<b>100</b>	<b>160</b>	<b>225</b>	<b>315</b>
<b>80</b>	<b>112</b>	<b>180</b>	<b>250</b>	

Pos. 6 = Length of stator pack:

	63	71	80	90	100	112	132	160	180	200	225	250	280	315
Extra short							SA							
Short	A	A	A	S	LA		SB	S	MA		LA	S		S S
Medium						M	MB	M	MB	M			M	
Long	B	B	B	L	LB		ML	L	L	L	LB	M		M M
Extra long			L									ML		L

\* Three-phase, 2-speed version

Pos. 7 = Polarity:

<b>2</b>	2 poles	<b>24</b>	Double polarity: 2 / 4 poles	<b>46</b>	Double polarity: 4 / 6 poles
<b>4</b>	4 poles	<b>28</b>	Double polarity: 2 / 8 poles	<b>48</b>	Double polarity: 4 / 8 poles
<b>6</b>	6 poles	<b>21</b>	Double polarity: 2 / 12 poles	<b>41</b>	Double polarity: 4 / 12 poles
<b>8</b>	8 poles			<b>43</b>	Double polarity: 4 / 16 poles
<b>10</b>	10 poles			<b>68</b>	Double polarity: 6 / 8 poles
<b>12</b>	12 poles			<b>61</b>	Double polarity: 6 / 12 poles

Pos. 8 = Mounting (IM Code I):

<b>B3</b>	<b>V5</b>	<b>V6</b>
<b>B5</b>	<b>V1</b>	<b>V3</b>
<b>B14</b>	<b>V18</b>	<b>V19</b>
<b>B35</b>	<b>V15</b>	<b>V36</b>

Pos. 9 = Supply:

<b>3F xxxD / xxxS / xx</b>	Three-phase 1-speed; voltage for delta connection; voltage for star connection; frequency
<b>3F xxx / xx</b>	Three-phase, 2-speed: voltage; frequency
<b>1F xxx / xx</b>	Single-phase; voltage; frequency

**A B 2 5 132 S 46 B5 3F 400/50 = Example of the commercial codes**

## 2. Design features

### 2.1 Mounting arrangements

#### 2.1 Mounting arrangements

The most commonly used mounting arrangements are shown in the table 2 A. Other mounting arrangements are available on request.

Standard motors ordered in basic mounting arrangements (universal mounting arrangements)

IM B3, IM B5 or IM B14 can also be operated in the following different mounting positions:

- IM B3 in IM B6, IM B7, IM B8, IM V5 or IM V6,
- IM B5 in IM V1 or IM V3,
- IM B14 in IM V18 or IM V19.

According to the safety standard for electrical machines, foreign objects must be prevented from falling into the fan cover.

Motors for vertical arrangement with shaft end down are fitted with a protective hood over the fan cowl.

Table 2 A

#### Size 63 ÷ 315

Foot-mounted motor

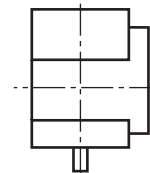
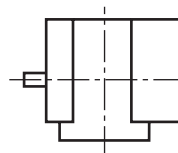

CEI 2-14

B3

V5

IEC EN 60034-7 code I

IM B3

IM V5

IEC EN 60034-7 code II

IM 1001

IM 1011

#### Size 63 ÷ 315

Flange-mounted motor:  
large flange,  
clearance fixing holes

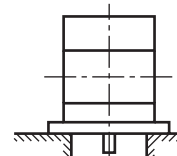
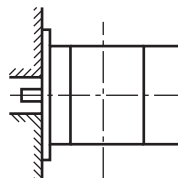

CEI 2-14

B5

V1

IEC EN 60034-7 code I

IM B5

IM V1

IEC EN 60034-7 code II

IM 3001

IM 3011

#### Size 63 ÷ 132

Flange-mounted motor:  
small flange,  
tapped fixing holes

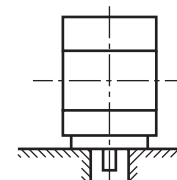
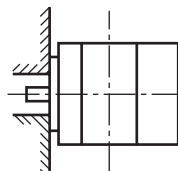

CEI 2-14

B14

V18

IEC EN 60034-7 code I

IM B14

IM V18

IEC EN 60034-7 code II

IM 3601

IM 3611

#### Size 63 ÷ 315

Foot and flange-mounted motor:  
large flange, clearance  
fixing holes

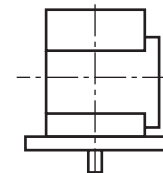
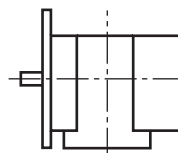

CEI 2-14

B3/B5

V5/V1

IEC EN 60034-7 code I

IM B35

IM V15

IEC EN 60034-7 code II

IM 2001

IM 2011

#### Size 63 ÷ 132

Foot and flange-mounted motor:  
with small flange, tapped fixing  
holes

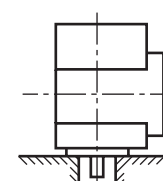
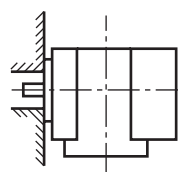

CEI 2-14

B3/B14

V5/V18

IEC EN 60034-7 code I

IM B34

IM 2111

IEC EN 60034-7 code II

IM 2101

IM 2111

## 2.1

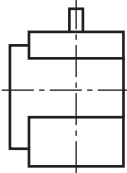

V6  
IM V6  
IM 1031

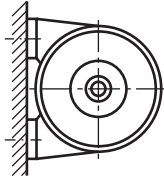

B6  
IM B6  
IM 1051

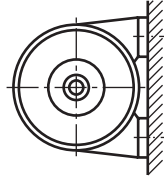

B7  
IM B7  
IM 1061

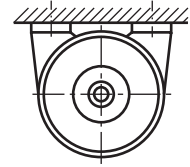

B8  
IM B8  
IM 1071

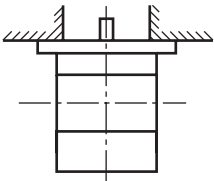

V3  
IM V3  
IM 3031

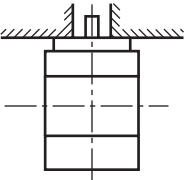

V19  
IM V19  
IM 3631

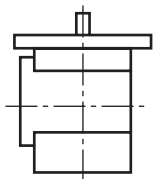

V6/V3  
IM V36  
IM 2031

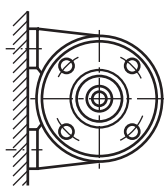

B6/B5  
IM 2051

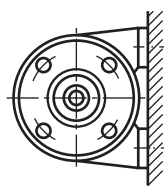

B7/B5  
IM 2061

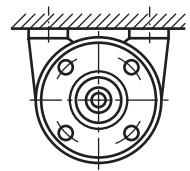

B8/B5  
IM 2071

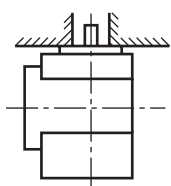

V6/V19  
IM 2131

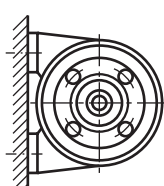

B6/B14  
IM 2151

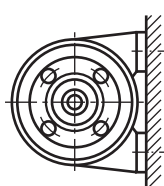

B7/B14  
IM 2161

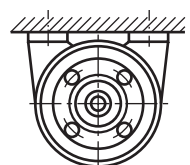

B8/B14  
IM 2171

## 2.2 Installation and application

### 2.2.1 Installation, mechanical enclosure and cooling

#### 2.2.1 Installation, mechanical enclosure and cooling

##### Standard installation

The motors can be installed outdoors and in dusty, moist and chemically aggressive environment (industrial climate) at ambient temperatures from -20 °C to 40 °C.

##### Mechanical protection (IP); Table 2 B

The mechanical protection systems for electric motors are classified with the IP code followed by two numbers and, in some applications, by a letter.

##### IP (International Protection):

this indicates the level of protection against accidental contacts of foreign bodies and against water.

##### 0 - 6 (1<sup>st</sup> digit):

this indicates the level of protection against accidental contacts of foreign bodies.

##### 0 - 8 (2<sup>nd</sup> digit):

this indicates the level of protection against water.

**W, S and M** (additional letters for special protections):

**W**; this means that the machine is to be used in specified weather conditions and with special protections.

The W letter has to be added to the IP code (e. g. IPW55).

**S and M**; these are used for protection against water.

The letter S stands for static protection; protection against water only for a stationary motor. Letter M stands for protection against water when the motor is running (e. g. IP56S).

Without the additional letters the protection applies in both cases (standing still and running motor).

Our standard motors are IP55 (terminal box IP65). On request we can supply motors without ventilation with IP56 or IP57, and self ventilated motors with IP56S.

##### Upper-Deck Installation

Motors meant for installation on board ships and offshore areas are designed to comply with the specifications of the relevant classification authorities (see page 22).

##### Gear mounting, Oil-protected Flange

In some applications, it is necessary that the flange and the drive shaft are completely sealed against oil. This need must be specified during the order phase.

##### Fixed bearings

Some applications need to have a "zero axial play". This need must be specified during the order phase.

##### Cooling

Motors are air-cooled by means of external surface ventilation (IC 411). Standard motors have radial flow fan allowing fully reversible rotation. Reference standards are: IEC 60034-6. From frame size 100 to 315 motors may be supplied with forced ventilation.

Table 2 B - Mechanical protection to IEC 60034-5

Protection against accidental contact and the penetration of foreign bodies	International protection	Protection against water
Complete protection against contact and approaching of voltage-carrying parts as well as against contact with rotating parts inside the housing. Protection against harmful dust deposits. The penetration of dust is not completely prevented but the dust cannot enter in such quantities as to affect operation.	<b>IP55</b> standard design	A jet of water squirting out of a nozzle towards the motor from all directions has no harmful effect.
	<b>IP56</b> special design	In case of temporary flood, e. g. heavy seas, water cannot enter into the motor in harmful quantities.
	<b>IP57</b> special design	Motor can operate under water at given pressure.
Complete protection against contact of voltage-carrying parts as well as against contact with rotating parts inside the housing. Protection against the penetration of dust (dust-proof).	<b>IP65</b> special design	A jet of water squirting out of a nozzle towards the motor from all directions as no harmful effect.

## 2.2

### 2.2.2 Low temperature version and anti-condensation heating

#### 2.2.2 Low temperature version and anti-condensation heating

##### Low Temperature Version

Motors intended for use at extremely low temperatures are specially designed.

Flameproof certificates are valid for temperatures as low as -50°C.

Motors equipped with heating coils keep the minimum temperature of a stopped motor at -20°C (see table 2 C).

As an alternative to heaters, the motors can be powered with low voltage via terminals U1 and V1 (see table 2 C).

Also, it is possible to use a special construction with suitable materials in low temperature areas (-50° C) as an alternative to heating the motor.

##### Anti-condensation heating

Condensate may form inside the motor due to temperature fluctuations.

To prevent this from happening, motors must be heated using strip type heaters on the end windings or low voltage power can be supplied to the winding via terminals U1 and V1.

The heat output is given in table 2 C.

It is vital that during the motor operation the heaters are turned off.

The supply voltage for the heaters is 230V ± 10% (115V ± 10% on request).

GB

**Table 2 C** - Data of the anti-condensation heater

Frame size	For preventing condensation							For protection at temperatures below -20 °C (down to -50 °C)						
	With heater	Via Motor winding						With heater	Via Motor winding					
		Output [W]	Output [VA]	Heating voltage with a rated motor voltage of					Output [W]	Output [VA]	Heating voltage with a rated motor voltage of			
			230V [V]	400V [V]	440V [V]	500V [V]	690V [V]			230V [V]	400V [V]	440V [V]	500V [V]	690V [V]
<b>63</b>	25	35	45	75	90	100	130	50	90	70	120	140	160	210
<b>71</b>	25	55	35	65	75	85	110	50	130	60	100	120	135	175
<b>80</b>	25	70	30	55	65	75	100	50	180	50	90	100	115	155
<b>90</b>	25	100	25	45	50	60	80	50	250	40	70	80	95	125
<b>100</b>	25	140	20	35	40	50	65	50	440	40	65	75	85	115
<b>112</b>	50	190	20	38	45	50	65	100	490	35	60	70	80	105
<b>132</b>	50	300	20	35	40	45	60	100	700	30	55	65	70	90
<b>160</b>	50	420	17	30	35	40	50	100	950	25	45	55	60	80
<b>180</b>	100	500	15	25	30	35	45	200	1200	25	40	50	55	70
<b>200</b>	100	720	13	20	25	30	40	200	1500	20	35	40	45	60
<b>225</b>	100	800	13	20	25	30	40	200	2200	20	35	40	45	60
<b>250</b>	100	950	10	20	25	30	40	200	2700	20	35	40	45	60
<b>280</b>	200	1700	---	20	22	25	30	400	3000	---	28	35	40	50
<b>315</b>	200	1900	---	16	20	25	30	400	3600	---	25	32	38	48
<b>315 L</b>	200	2100	---	14	18	24	30	400	4800	---	22	30	35	45



## 2.3 Materials, painting and nameplate

### 2.3 Materials, painting and nameplate

#### Materials



Table 2 D - Materials of the main components:

Frame size	63 ÷ 250	280 ÷ 315
Frame	Cast iron G200 (ISO 185)	Cast iron G200 (ISO 185)
Endshields		
Terminal box		
Fan cover	Steel	Steel
Rain cap		
Fan	Non sparking thermoplastic material or aluminium	Aluminium
Shaft	Steel C40	Steel C40
Rotor	Squirrel cage in pressure cast aluminium	Squirrel cage in pressure cast aluminium
Winding	Insulation class F or H	Insulation class F or H
Bolts and screws	Galvanised steel 8.8 or A4-80 UNI EN ISO 3506-1	Steel 8.8 zincod
Cable gland (on request)	Brass or stainless steel	Brass or nickel-plated brass

Painting - Table 2 E - Paint system and characteristics

Frame size	63 ÷ 250	280 ÷ 315
Pretreatment	All components are sandblasted, cleaned and degreased	All components are sandblasted, cleaned and degreased
Painting	Polymerised epoxy polyester powder, oven-baked at 200°C	Treatment with anti-corrosion primer Final coat of enamel paint
Thickness	Total 120 µm (different thicknesses available upon request)	Total 120 µm (different thicknesses available upon request)
Colour	RAL 5010 (special colours available upon request)	RAL 5010 (special colours available upon request)
Mechanical strength	Non-abrasive, elastic, insensitive to scratches, resistant to impact	Non-abrasive, elastic, insensitive to scratches, resistant to impact
Corrosion resistance	Highly resistant to water, water vapour, salt water	Highly resistant to water, water vapour, salt water
Chemical resistance	Good resistance in chemically aggressive environments	Good resistance in chemically aggressive environments
Temperature range	-40 °C +130°C	-40 °C +130°C

#### Nameplate

  	
0722 CESI 02ATEX122 n000001 y04	
Electric Motor AB30 160L 4 3~	
II 2G Exd IIB T4 IP55	
⊕	⊖
V	A Hz 1/min cos φ kW
400Δ	30,00 50 1470 0,79 15,00
690λ	17,32
V range 380÷420Δ, 660÷720λ ±5%	
IC411 CLF Ta40 °C S1	
item kg 195	
Manufacturer Cemp srl - I 20030 SENAGO (Milan) - ITALY	
regrease joints after any dismantling - fasteners quality 8.8 EN 898-1	

The stainless steel nameplate is fitted on the motor frame.

Fig. 2 A

## 2.4 Shaft ends, balancing, vibrations, noise levels, coupling and belt drives

### 2.4 Shaft ends, balancing, vibrations, noise levels, coupling and belt drives

#### Shaft ends

The shaft ends are cylindrical and comply with IEC 60072 in their design and in their correspondence to frame sizes and outputs.

The shaft ends of all motors are equipped with a tapped hole to assist in the fitting of pulleys and couplings.

The keys are always supplied along with the motors.

On request, special shaft ends or a second free shaft end can be provided.

Pole-changing motors with a 2-pole speed have the same shaft ends as single-speed 2-pole motors.

#### Balancing, and vibration

The motors are dynamically balanced with half keys in accordance with vibration grade "A" (N) normal balance IEC 60034-14 (and ISO 8821).

The low-vibration version "B" (R) (reduced) can be supplied where high demands are made on quiet running.

Care must be taken to ensure that transmission parts (pulleys, couplings) supplied by others are dynamically balanced with half key.

#### Noise level

Noise measurements are performed to IEC 60034-9.

In the performance data, the sound pressure levels "Lp" are given in dB (A) for the individual frame sizes.

They apply for no load at 50 Hz. The tolerance is + 3 dB (A).

At 60 Hz the values of sound pressure increase approximately by 4 dB (A).

#### Coupling drive

When aligning a motor to be coupled directly to the machine, care must be taken that the rollers and balls of the bearings do not jam.

Elastic couplings are permissible with all motors.

To ensure vibration-free running and to avoid any inadmissible stress on the bearings, the machine to be coupled must still be exactly aligned in the case of elastic coupling.

Maximum accuracy must be applied to the coupling of 2-pole motors.

#### Belt drive

Slide rails are used for motors for easy tensioning and readjustment at the belts.

Permissible forces have to be taken into consideration (See Table 2 I).

Pulleys and couplings must only be fitted and removed by means of specific tools.

GB

Table 2 F - Vibration limits according to IEC 60034-14

Balancing rate	Limit values of the speed of vibration/oscillation for frame sizes:		
	63 ÷ 132 [mm/s]	160 ÷ 280 [mm/s]	315 [mm/s]
<b>A</b>	1.6	2.2	2.8
<b>B</b>	0.7	1.1	1.8

Terms of measure: Free standing

## 2.5 Bearing system

### 2.5.1 Bearing system

### 2.5.1 Bearing system

**Table 2 G** - Standard model -  
Closed non-lubricated bearings

Frame size	Poles	Bearing	
		Drive end	Non-Drive end
63	2 - 4 - 6 - 8	6202 ZZ	
71	2 - 4 - 6 - 8	6203 ZZ	
80	2 - 4 - 6 - 8	6204 ZZ	
90	2 - 4 - 6 - 8	6205 ZZ	
100	2 - 4 - 6 - 8	6206 ZZ	
112	2 - 4 - 6 - 8	6306 ZZ	
132	2 - 4 - 6 - 8	6308 ZZ C3	
160	2 - 4 - 6 - 8	6309 ZZ C3	
180	2 - 4 - 6 - 8	6310 ZZ C3	
200	2 - 4 - 6 - 8	6312 ZZ C3	
225	2 - 4 - 6 - 8	6313 ZZ C3	
250	2	6313 ZZ C3	
	4 - 6 - 8	6314 ZZ C3	6313 ZZ C3
280	2 - 4 - 6 - 8	6316 ZZ C3	
315	2	6316 ZZ C3	
	4 - 6 - 8	6317 ZZ C3	6316 ZZ C3

**Table 2 H** - Upon request -  
Open bearings with lubricators

Frame size	Poles	Bearing			Time interval for lubrication (hours)	Amount of grease*	
		Front ball bearings	Front rollers	Rear ball bearings			
160	2	6309 C3	NU 309 EC	6309 C3	5500	12 g	
	4				8250		
	6 - 8				11000		
180	2	6310 C3	NU 310 EC	6310 C3	2000	12 g	
	4				6000	15 g	
	6 - 8				7000		
200	2	6312 C3	NU 312 EC	6312 C3	2100	12 g	
	4				5000	15 g	
	6 - 8				7000		
225	2	6313 C3	NU 313 EC	6313 C3	2000	15 g	
	4				4500	18 g	
	6				5600		
	8				6400		
250	2	6313 C3	NU 313 EC	6313 C3	2000	18 g	
	4	6314 C3	NU 314 EC		4100	20 g	
	6				5300		
	8				6200		
280 S	2	6316 C3	NU 316	6316 C3	4100	33 g	
	4				5000		
	6				5250		
	8				5800		
280 M	2	6316 C3	NU 316	6316 C3	3700	33 g	
	4				4300		
	6				4600		
	8				4800		
315 S	2	6316 C3	NU 316	6316 C3	3300	33 g	
	4	6317 C3	NU 317		9500		37 g
	6				13700		
	8				15300		
315 M	2	6316 C3	NU 316	6316 C3	2900	33 g	
	4	6317 C3	NU 317		7800		37 g
	6				11300		
	8				13600		
315 LA	2	6316 C3	NU 316	6316 C3	4100	33 g	
	4 - 6	6317 C3	NU 317		11100		37 g
	8				19500		
315 LB	2	6316 C3	NU 316	6316 C3	3500	33 g	
	4 - 6	6317 C3	NU 317		9500		37 g
	8				16550		
315 LC	2	6316 C3	NU 316	6316 C3	2900	33 g	
	4 - 6	6317 C3	NU 317		7800		37 g
	8				13600		

\* Grease type LGHP2 SKF or equivalent.

## 2.5

### 2.5.1 Bearing system

#### 2.5.2 Bearing section

Standard motors are equipped with radial deep groove ball bearings (ZZ pre-greased series) or open bearings complete with grease nipples.

Where requested roller, or other special bearings can be fitted.

#### Lubrication

The ZZ series bearings are lubricated for life and require no further lubrication.

Open bearings are supplied with grease nipples and are to be lubricated according to the indications given in the table 2 G - 2 H.

#### Bearing Seal

In order to prevent dust and water penetration, a seal ring is fitted to the endshield on the driving and non-driving ends.

These seal rings are highly resistant to vibrations, thermally stable, and resistant to mineral oils and diluted acids.

Seals for media not listed above are available on request.

GB

### 2.5.2 Bearing section

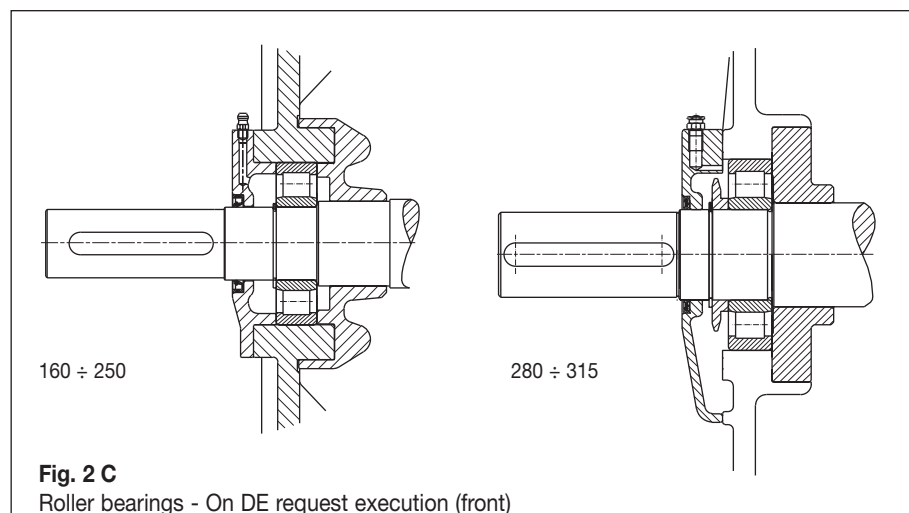
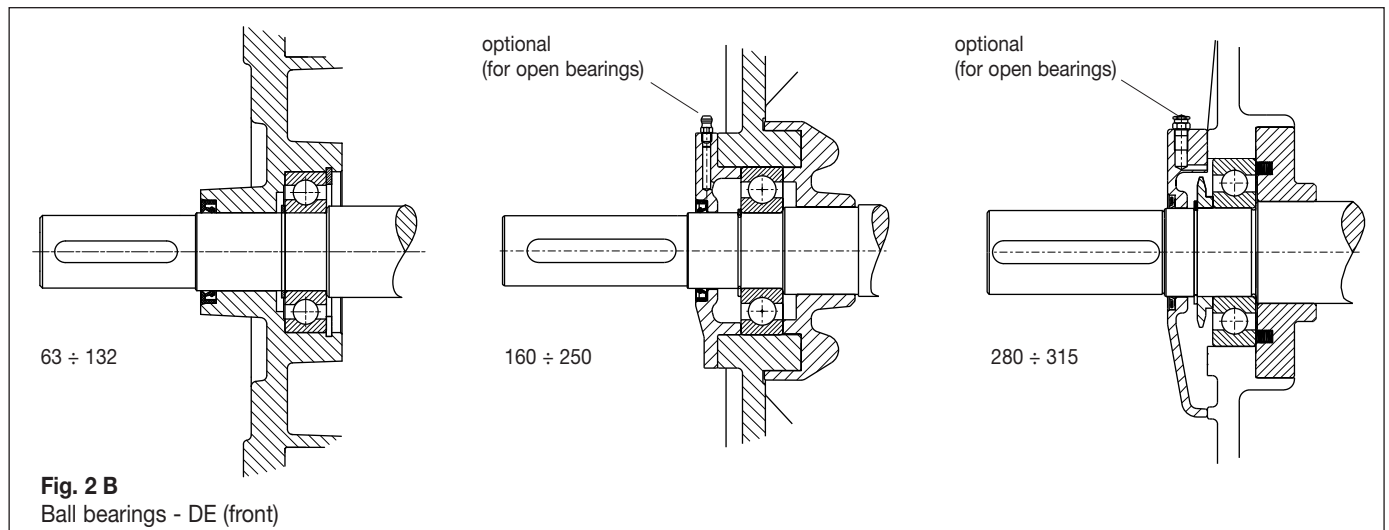

## 2.5

### 2.5.3 Permissible radial loads

#### 2.5.3 Permissible radial loads on the shaft with standard bearings

Table 2 I shows the values of radial load calculated considering:

- frequency 50 Hz
- temperature not exceeding 90°C
- 20,000 hours of life for 2-pole motors;
- 40,000 hours of life for 4, 6, 8-pole motors

For operation at 60 Hz the values have to be reduced by 6% in order to achieve the same useful life. For double speed motors consider always the higher speed.

The distance of the point of action of force  $F_R$  from the shoulder of the shaft must not exceed the length of the shaft end.

$F_R$  = maximum radial load (e. g. belt load + weight of belt pulley)

$F$  = belt load [N] =  $\frac{2 \cdot K \cdot M}{D}$

$M$  = torque [Nm] =  $\frac{9550 \cdot P}{n}$

$P$  = rated motor output [kW]

$n$  = rated motor speed [1/min]

$D$  = belt pulley diameter [m]

$K$  = prestress factor governed by belt type: it is assumed approximately as follows

$K = 3$  for normal flat belts without tensioning pulley

$K = 2$  for normal flat belts with tensioning pulley

$K = 2.2$  for V-belts or special flat belts

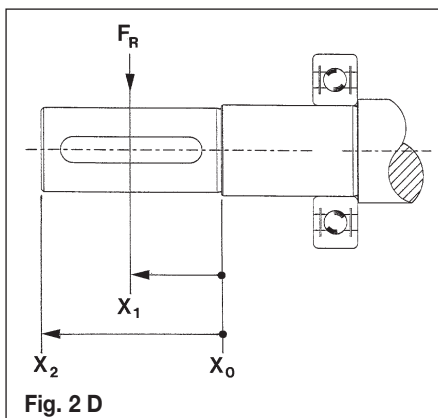

Table 2 I

Frame size	Pole number	Permissible radial load $F_R$ [N]					
		Ball bearings			Roller bearings		
		$X_0$	$X_1$	$X_2$	$X_0$	$X_1$	$X_2$
63	2	390	360	340	---	---	---
	4	390	360	340	---	---	---
	6	440	410	380	---	---	---
	8	490	450	420	---	---	---
71	2	490	450	420	---	---	---
	4	480	450	420	---	---	---
	6	550	510	480	---	---	---
	8	610	560	520	---	---	---
80	2	640	590	540	---	---	---
	4	640	580	540	---	---	---
	6	730	660	610	---	---	---
	8	800	730	670	---	---	---
90	2	730	660	610	---	---	---
	4	720	660	600	---	---	---
	6	820	750	680	---	---	---
	8	910	820	750	---	---	---
100	2	1020	910	830	---	---	---
	4	1010	910	820	---	---	---
	6	1150	1030	940	---	---	---
	8	1270	1140	1030	---	---	---
112	2	1480	1350	1240	---	---	---
	4	1470	1340	1230	---	---	---
	6	1680	1530	1410	---	---	---
	8	1850	1680	1550	---	---	---
132	2	2160	1930	1750	---	---	---
	4	2140	1910	1720	---	---	---
	6	2450	2190	1970	---	---	---
	8	2700	2410	2180	---	---	---
160	2	2790	2470	2210	5720	5200	4680
	4	2770	2450	2190	5885	5350	4815
	6	3150	2790	2490	5995	5450	4905
	8	3480	3080	2750	6050	5500	4950
180	2	3600	3200	2950	6490	5900	5310
	4	3500	3350	2850	7040	6400	5760
	6	3900	3600	3300	7370	6700	6030
	8	4300	3950	3700	7480	6800	6120
200	2	4500	4300	4000	9680	8800	7920
	4	4550	4350	4100	10450	9500	8550
	6	5300	5500	5000	10780	9800	8820
	8	5500	5350	5050	10945	9950	8955
225	2	5500	5000	4650	11880	10800	9720
	4	5350	4900	4500	12760	11600	10440
	6	5950	5650	5200	13200	12000	10800
	8	6400	6100	5700	13420	12200	10980
250	2	5300	5100	4750	13860	12600	11340
	4	5650	5400	5300	15950	14500	13050
	6	5820	5600	5370	16500	15000	13500
	8	6420	5980	5520	16665	15150	13635
280	2	5500	5000	4500	15400	14000	12600
	4	5665	5150	4635	15950	14500	13050
	6	6930	6300	5670	16500	15000	13500
	8	7920	7200	6480	18150	16500	14850
315 S-M	2	5500	5000	4500	14300	13000	11700
	4	6270	5700	5130	28050	25500	22950
	6	7370	6700	6030	29150	26500	23850
	8	8360	7600	6840	29700	27000	24300
315 L	2	6820	6200	5580	13640	12400	11160
	4	7095	6450	5805	24750	22500	20250
	6	8030	7300	6570	27500	25000	22500
	8	9020	8200	7380	30800	28000	25200

## 2.5

### 2.5.4 Permissible axial load on the shaft

#### 2.5.4 Permissible axial load on the shaft with standard bearings

If the shaft end is loaded at  $X_2$  with the permissible radial load  $F_R$  an additional axial load  $F_A$  is allowed (table 2 L).

If the permissible radial load is not fully utilized, higher loads are possible in axial direction (Values on request).

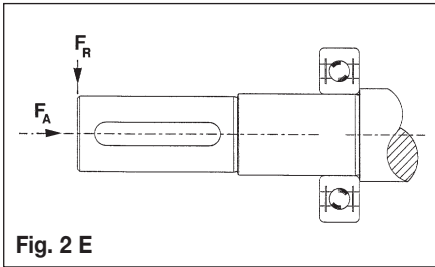

Fig. 2 E

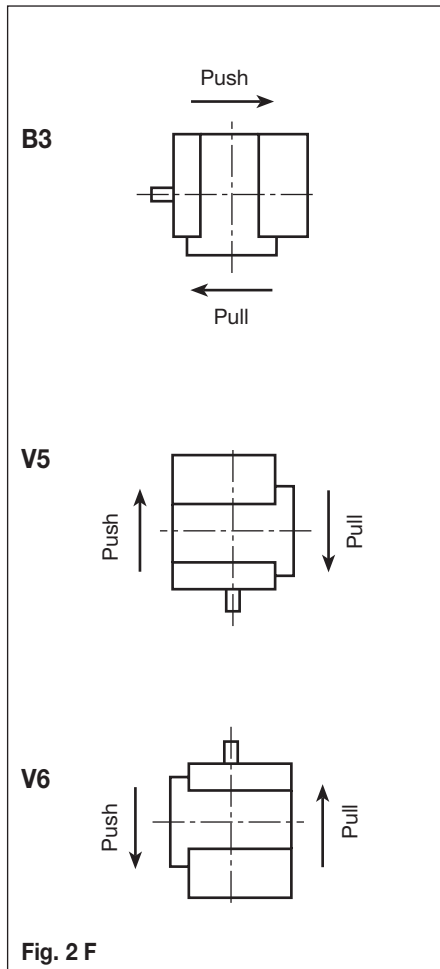

Fig. 2 F

Table 2 L

Frame size	Pole number	Limit axial load with $F_R$ at $X_2$ - $F_A$ [N]			
		Ball bearings		Roller bearings	
		B3 push/pull	V5/V6 push/pull	B3 push/pull	V5/V6 push/pull
63	2	120	110	---	---
	4	120	110	---	---
	6	140	130	---	---
	8	160	150	---	---
71	2	140	130	---	---
	4	140	120	---	---
	6	170	150	---	---
	8	190	170	---	---
80	2	190	170	---	---
	4	190	160	---	---
	6	220	190	---	---
	8	250	220	---	---
90	2	200	170	---	---
	4	200	160	---	---
	6	240	190	---	---
	8	270	220	---	---
100	2	280	230	---	---
	4	280	220	---	---
	6	330	260	---	---
	8	370	300	---	---
112	2	410	330	---	---
	4	410	320	---	---
	6	480	370	---	---
	8	540	430	---	---
132	2	590	430	---	---
	4	590	380	---	---
	6	690	470	---	---
	8	780	560	---	---
160	2	750	490	1000	700
	4	750	450	1200	840
	6	880	520	1300	910
	8	1000	640	1400	980
180	2	880	950	1000	700
	4	880	1150	1250	875
	6	1030	1350	1350	945
	8	1160	1550	1550	1085
200	2	1160	1100	1100	770
	4	1160	1200	1200	840
	6	1360	1400	1400	980
	8	1520	1600	1600	1120
225	2	1300	1250	1250	875
	4	1300	1350	1350	945
	6	1520	1600	1600	1120
	8	1710	1850	1850	1295
250	2	1460	1300	1300	910
	4	1460	1400	1400	980
	6	1710	1600	1600	1120
	8	1920	1920	1900	1330
280	2	5500	3850	3700	2590
	4	5500	3850	3700	2590
	6	6500	4550	4000	2800
	8	7400	5180	4500	3150
315 S-M	2	5500	3850	3700	2590
	4	5800	4060	3500	2450
	6	6800	4760	4000	2800
	8	7650	5355	4500	3150
315 L	2	2200	1540	3850	2695
	4	2200	1540	3800	2660
	6	2500	1750	4600	3220
	8	3000	2100	5500	3850

## 2.6 Terminal box

### 2.6.1 Terminal box design

#### 2.6.1 Terminal box design

The standard design has four basic versions:

- Ex d IIB
- Ex d IIC
- Ex de IIB
- Ex de IIC

GB

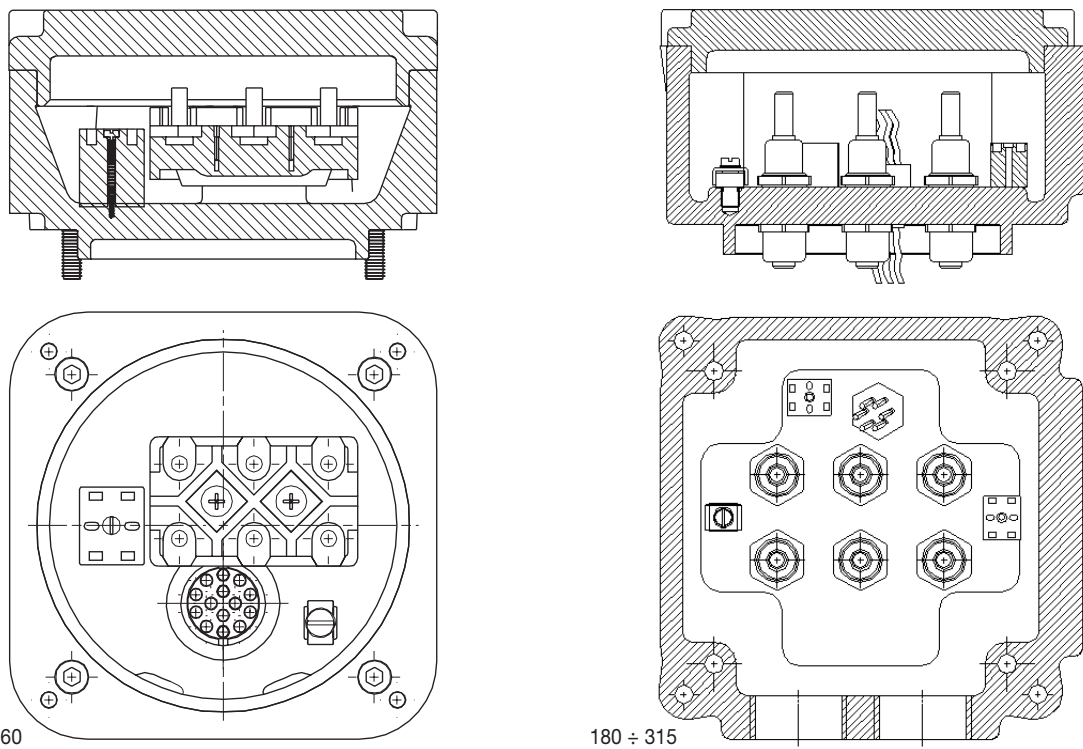

Fig. 2 G - Terminal box, design IIB

On request we can supply:

- additional terminal box for auxiliary terminals (Fig. 2 H)
- motors without terminal box and with leads (Fig. 2 I)
- bigger terminal box with capacitor for single phase motors (Fig. 2 L).

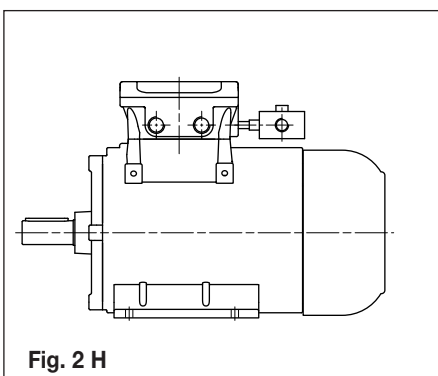

Fig. 2 H

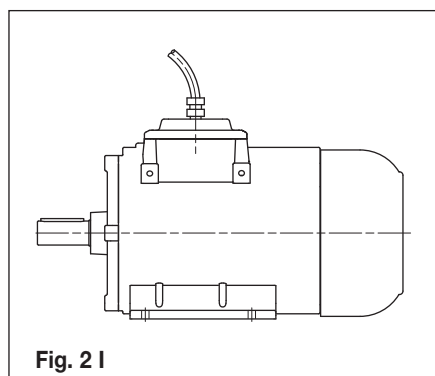

Fig. 2 I

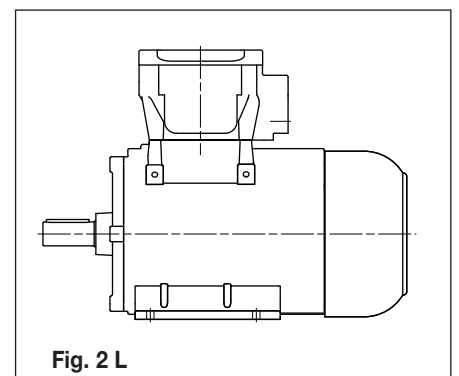

Fig. 2 L

## 2.6

### 2.6.2 Position of terminal box and terminals

#### 2.6.3 Cable-entries

### 2.6.2 Position of terminal box and terminals

The terminal box is usually located on top and can be turned through  $4 \times 90^\circ$  (Fig. 2 M).

For a horizontal mounted motor the cable entry is normally located on the right side (looking at the driving-end).

Cable entry:

- standard position: 1
- special positions upon request: 2, 3, 4.

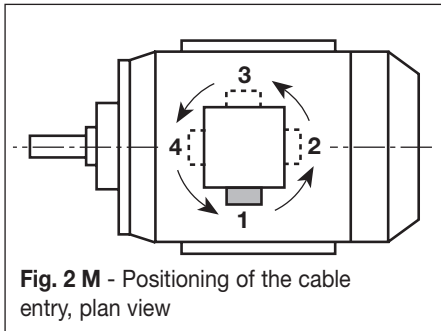

**Fig. 2 M** - Positioning of the cable entry, plan view

#### Terminals and earthing terminal

There are a maximum number of 6 power terminals in the terminal box.

The type of monitoring device depends on the number of possible additional terminals in the main terminal box.

PTC thermistors can be connected to two additional terminals.

Two terminals are also necessary for connecting the anticondensation heater.

For PT 100 (RTD) thermistors, 3 or 4 terminals are necessary depending on the type chosen.

An earthing terminal is located in the terminal box and another earthing terminal is located on motor frame.

### 2.6.3 Cable-entries

As standard, the motors are delivered with one or two threaded cable entries for flameproof packing glands.

Ex de motors can be also provided with Ex e packing glands.

Motors fitted with thermodetectors or heaters are always provided with additional cable entry.

**Table 2 N**

Mains connection cable entries				
Frame size	Mains power supply	Power supply from an inverter	Conical threading upon request*	
			ANSI B 2.1	UNI 6125
63 ÷ 112	1 x M25	1 x M25 + 1 x M20	NPT 3/4"	Gk 3/4"
132 ÷ 160	2 x M32	1 x M32 + 1 x M20	NPT 1"	Gk 1"
180 ÷ 250	2 x M40	1 x M40 + 1 x M20	NPT 1.1/2"	Gk 1.1/2"
280 ÷ 315	2 x M63	1 x M63 + 1 x M20	NPT 2"	Gk 2"
Auxiliaries cable entries				
63 ÷ 315	----	1 x M20	NPT 1/2"	Gk 1/2"

\* Other threads available upon request



# 3. Electrical design

## 3.1 Standard operating conditions

### 3.1 Standard operating conditions

#### Output

The rated outputs and operating characteristics given in the performance data refer according to IEC 60034-1 to:

- continuous duty (S1)
- frequency of 50Hz
- voltage 400V (230V for single phase)
- maximum ambient temperature of 40 °C
- maximum height of installation of 1000 m above sea level.

Motors can also be operated in ambient temperatures from 40 °C up to 80 °C and at altitudes of more than 1000 m up to 4000 m above sea level.

In these cases the rated output given in the tables must be reduced in accordance with table 3 A or a larger motor has to be chosen.

The rated data does not need to be changed if at altitudes in excess of 1000 m above sea level the ambient temperature is reduced according to the following table:

Altitude of installation [m]	Maximum ambient temperature [°C]
0 to 1000	40
1000 to 2000	30
2000 to 3000	19
3000 to 4000	9

#### Voltage, frequency

The motors as standard are built to run at the voltage and frequency with the tolerances indicated in figure 3 A.

The motors can run with the variations envisaged in normal operational areas at a voltage of ± 5% and frequency of ± 2%.

Furthermore, the motors can be used in the operational area with restrictions (variations in voltage of ± 10% and frequency of ± 3%) as long as the indications given by norm 60034-1 are complied with.

**Table 3 A** - Power variation of standard motors in case of coolant temperature different from 40 °C or height of installation over 1000 m above sea-level

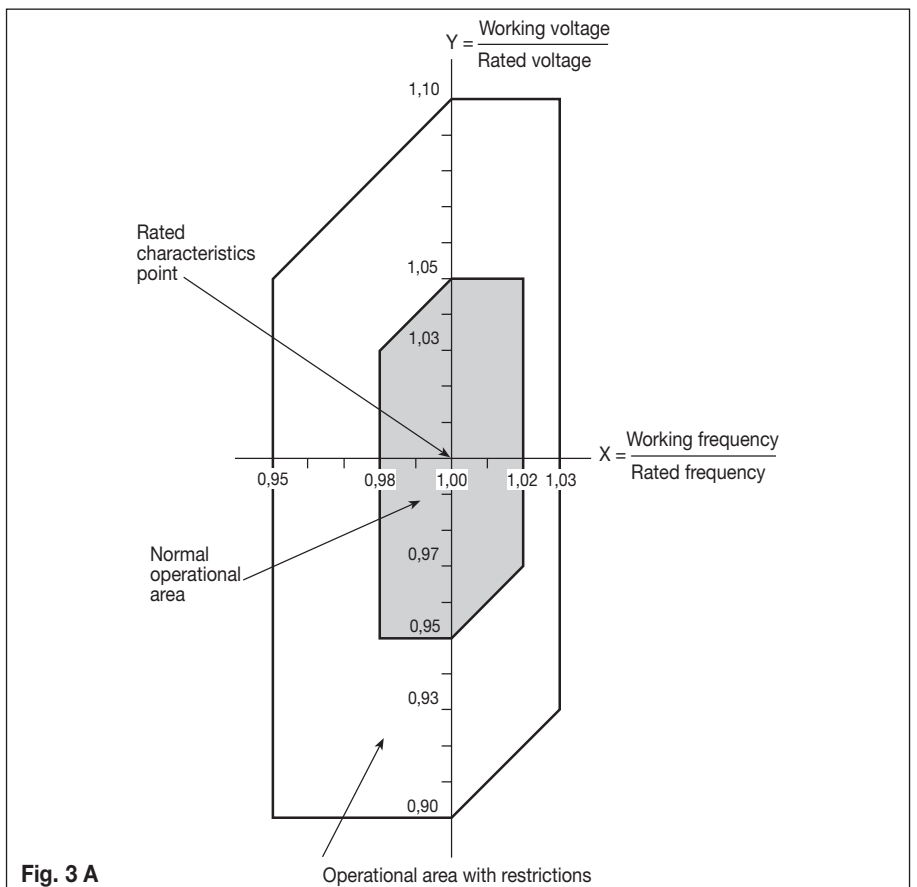
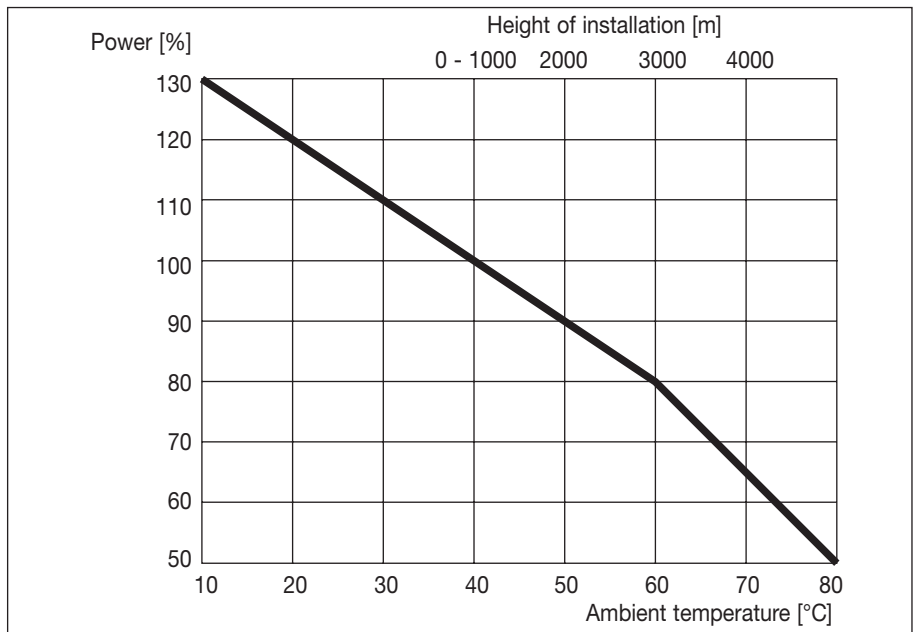

**Fig. 3 A**

GB

### 3.1 Standard operating conditions

#### Torque

The motors are fitted with squirrel-cage rotors suitable for direct-on-line starting.

The resulting starting and maximum torques, expressed as a multiple of the rated torques are given in the performance data.

A deviation in the voltage from the rated value changes the torques as an approximate function of the square of the voltages.

Normally two-speed motors have a nominal torque that is roughly the same for both speeds.

A version is also available with quadratic torque, for centrifugal machines (fans, pumps). In this case, the torque at the lower speed is roughly half that available at the higher speed.

#### Rated current

In the performance data the rated currents are only indicated for a rated voltage of 400V.

For other voltages the rated currents are inversely proportional to the voltages:

$$\frac{U}{U'} = \frac{I'}{I}$$

This results in:

$$I' = \frac{U \cdot I}{U'}$$

#### Speed

The rated speeds shown in the performance data are valid for 50 Hz and the rated speed equals synchronous speed less slip.

The following speeds result from the number of poles and the mains frequencies of 50 and 60 Hz:

Pole number	No-load speed at	
	50 Hz [1/min]	60 Hz [1/min]
2	3000	3600
4	1500	1800
6	1000	1200
8	750	900
10	600	720
12	500	600
16	375	450

#### Direction of rotation

The motors can be operated in both directions of rotation. If the phases are connected in the sequence L1, L2, L3 to the terminals U1, V1, W1, the motor turns clockwise.

The direction of rotation can be reversed by interchanging any two phases.

#### Note regarding electro-magnetic compatibility

Low voltage induction motors, if installed correctly and connected to the power supply, respect all immunity and emission limits as set out in the regulations relating to electro-magnetic compatibility (EMC "Generic Standard" for industrial environments).

In the case of supply by means of electronic impulse devices (inverters, soft starters etc.), all verifications and any modifications, necessary to ensure that emission and immunity limits, as stated within the regulations, are respected, are the responsibility of the installer.

#### Tolerances

According to IEC 60034-1 the electrical data stated in the tables are subject to the following tolerances:

Efficiency:

$$P_n \leq 50 \text{ kW: } - 0.15 (1-\eta)$$

$$P_n > 50 \text{ kW: } - 0.10 (1-\eta)$$

$$\text{Power factor: } - \frac{1 - \cos \varphi}{6}$$

(minimum 0.02 - maximum 0.07)

Slip at rated load operating temperature:  
± 20% of rated slip.

Locked rotor torque (starting torque):  
- 15% + 25%

Maximum torque: - 10%.

Current with locked rotor: + 20% (no lower limit).

## 3.2 Efficiency and power factor at partial load

### 3.2 Efficiency and power factor at partial load

The efficiency and power factor values shown in the performance data refer to rated output at 50Hz.

Values at partial load given in table 3 B, 3 C are for approximate reference only.

GB

Table 3 B

Efficiency in % at			
1/2	3/4	4/4	5/4
of full load			
94	95	<b>96</b>	95
93	94	<b>95</b>	94
92	93	<b>94</b>	93
91	92	<b>93</b>	92
91	92	<b>92</b>	91
89	91	<b>91</b>	90
88	90	<b>90</b>	88
87	89	<b>89</b>	87
86	88	<b>88</b>	86
85	87	<b>87</b>	84
85	86	<b>86</b>	84
84	86	<b>85</b>	83
83	85	<b>84</b>	82
82	84	<b>83</b>	81
80	82	<b>82</b>	80
79	81	<b>81</b>	79
78	80	<b>80</b>	78
77	79	<b>79</b>	77
75	78	<b>78</b>	76
74	77	<b>77</b>	75
73	76	<b>76</b>	74
72	75	<b>75</b>	73
71	74	<b>74</b>	72
70	73	<b>73</b>	71
68	72	<b>72</b>	70
67	71	<b>71</b>	69
66	70	<b>70</b>	68
65	69	<b>69</b>	67
64	67	<b>68</b>	66
62	66	<b>67</b>	65
61	65	<b>66</b>	64
60	64	<b>65</b>	63
59	63	<b>64</b>	62

Table 3 C

Power factor at			
1/2	3/4	4/4	5/4
of full load			
0.85	0.91	<b>0.93</b>	0.93
0.84	0.90	<b>0.92</b>	0.92
0.81	0.88	<b>0.91</b>	0.91
0.80	0.87	<b>0.90</b>	0.91
0.77	0.86	<b>0.89</b>	0.90
0.75	0.84	<b>0.88</b>	0.89
0.73	0.83	<b>0.87</b>	0.88
0.71	0.81	<b>0.86</b>	0.88
0.69	0.80	<b>0.85</b>	0.87
0.68	0.79	<b>0.84</b>	0.87
0.67	0.78	<b>0.83</b>	0.86
0.65	0.77	<b>0.82</b>	0.85
0.64	0.75	<b>0.81</b>	0.85
0.62	0.74	<b>0.80</b>	0.84
0.61	0.72	<b>0.79</b>	0.83
0.60	0.71	<b>0.78</b>	0.82
0.58	0.70	<b>0.77</b>	0.81
0.57	0.69	<b>0.76</b>	0.80
0.55	0.67	<b>0.75</b>	0.79
0.54	0.66	<b>0.74</b>	0.79
0.53	0.65	<b>0.73</b>	0.78
0.52	0.63	<b>0.72</b>	0.77
0.50	0.62	<b>0.71</b>	0.76
0.49	0.61	<b>0.70</b>	0.75
0.48	0.59	<b>0.69</b>	0.74
0.47	0.58	<b>0.68</b>	0.74
0.46	0.57	<b>0.67</b>	0.73
0.45	0.56	<b>0.66</b>	0.72
0.44	0.55	<b>0.65</b>	0.71
0.43	0.54	<b>0.64</b>	0.70
0.42	0.53	<b>0.63</b>	0.69
0.41	0.52	<b>0.62</b>	0.68
0.40	0.51	<b>0.61</b>	0.67

### 3.3 Insulation and temperature rise

### 3.3 Insulation and temperature rise

#### Insulation

The components of the insulation system were selected so as to ensure good protection against chemically aggressive gases, vapours, dust, oil and air humidity. All materials used for insulating the winding and winding ends correspond to insulating classes F or H according to IEC 60085:

- Enamel-insulated copper wires with temperature index 200 (class H);
- Insulating sheet on polyester base (class F);
- Impregnation with fenolic resins modified with polyester resins (class H);

**Table 3 D** - Limit temperature for insulating material according IEC 60085

Insulation class	Limit temperature [°C]
B	130
F	155
H	180

#### Temperature rise

Standard single-speed motors in continuous service (excluding 315M) have temperature rises that are within the limits for class B.

Motors with higher output and pole-changing motors normally have temperature rise within class F limit.

**Table 3 E** - Temperature rise limit for rotating machines according IEC 60034-1

Insulation class	Max temperature rise[K]
B	80
F	105
H	125

According to Normative IEC 60034-1, the values shown in the table above may be up to 10 °C higher, with a feeding current variance of ± 5%.

## 3.4 Duty types

### 3.4 Duty types

In compliance with IEC 60034-1 the following duty-types are distinguished:

**Duty-type S1** - continuous running duty. Constant load operation.

**Duty-type S2** - short-time duty. Operating times of 10, 30, 60, and 90 minutes are recommended.

After each operating period the motor remains de-energized until the winding has cooled down to the ambient temperature.

**Duty-type where start-ups DO NOT INFLUENCE winding over-heating:**

**Duty-type S3** - intermittent periodic duty. Where starting does not influence the temperature. Duty cycle 10 minutes unless otherwise agreed upon. For the cyclic duration factor the values 15, 25, 40, and 60% are recommended.

**Duty-type S6** - continuous operation periodic duty.

Duty cycle 10 minutes unless otherwise agreed upon. For the cyclic duration factor the value 15, 25, 40, and 60% are recommended.

**Duty-types where starting and braking have a corresponding INFLUENCE on the temperature rise of the winding:**

**Duty-type S4** - intermittent periodic duty with starting. Intermittent periodical operation with identical cycles.

**Duty-type S5** - intermittent periodic duty with electric braking. Intermittent periodical operation with identical cycles, which include an electrical braking phase.

For S4 and S5 duty-types the following details must be given after this code:

- Intermittence ratio;
- The number of starts per hour;
- Moment of inertia of the motor;
- Moment of inertia of the load.

**Duty-type S7** - continuous operation periodic duty with electric braking.

**Duty-type S8** - continuous operation periodic duty with related load/speed changes.

**Duty-type S9** - duty with non-periodical load and speed variations.

Typical operation for motors powered by frequency converters.

Most of the real duty-type conditions represent a combination of duty-types as mentioned under 1. and 2.

In order to exactly determine a suitable motor details of all the operating conditions are required.

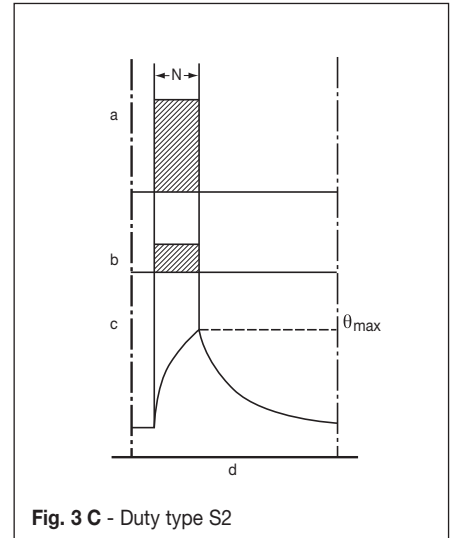
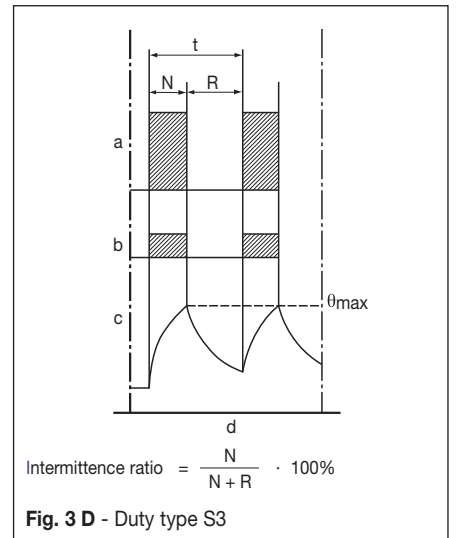

Fig. 3 C - Duty type S2



$$\text{Intermittence ratio} = \frac{N}{N + R} \cdot 100\%$$

Fig. 3 D - Duty type S3

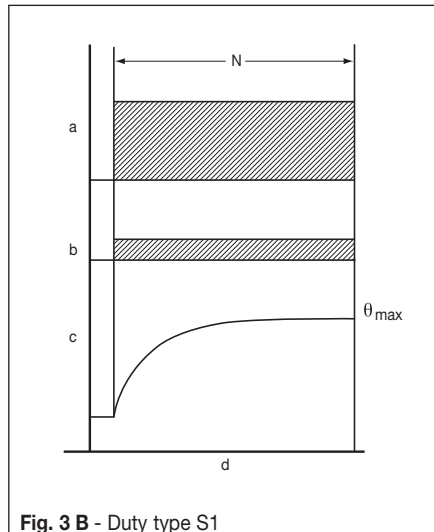
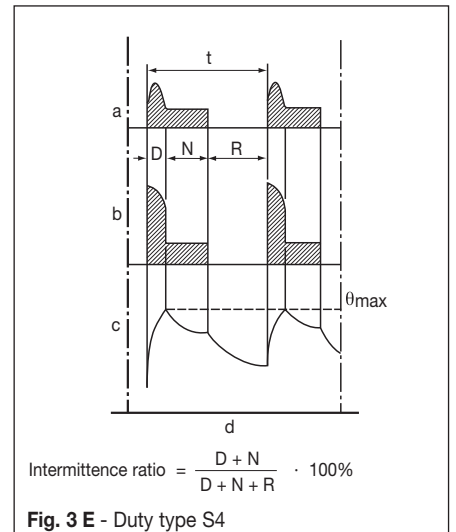

Fig. 3 B - Duty type S1



$$\text{Intermittence ratio} = \frac{D + N}{D + N + R} \cdot 100\%$$

Fig. 3 E - Duty type S4

N.B.:

The output ratings stated in the "Performance data" (Chapter 4.) apply to duty-type S1.

### 3.4 Duty types

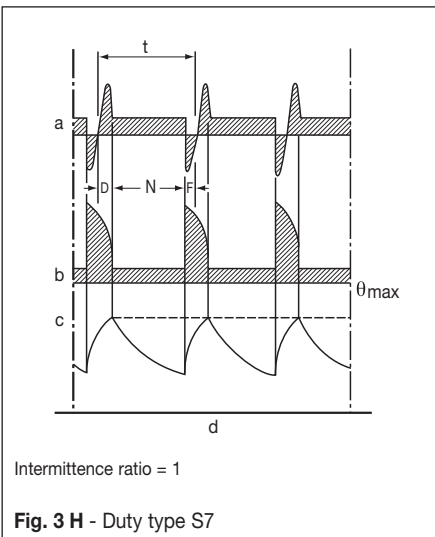
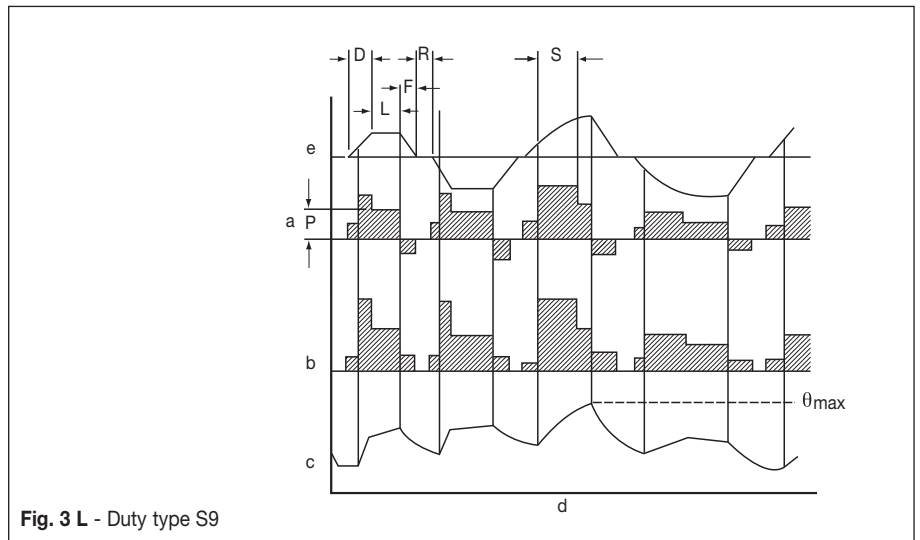
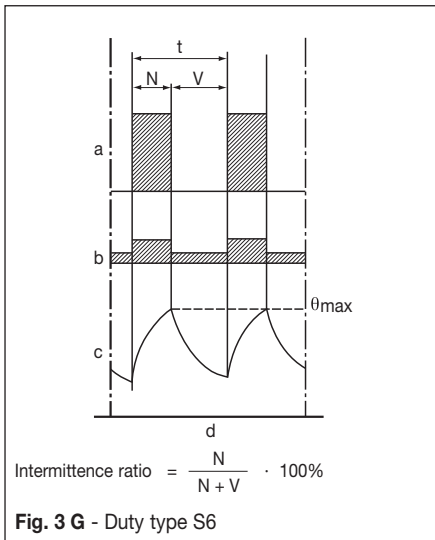
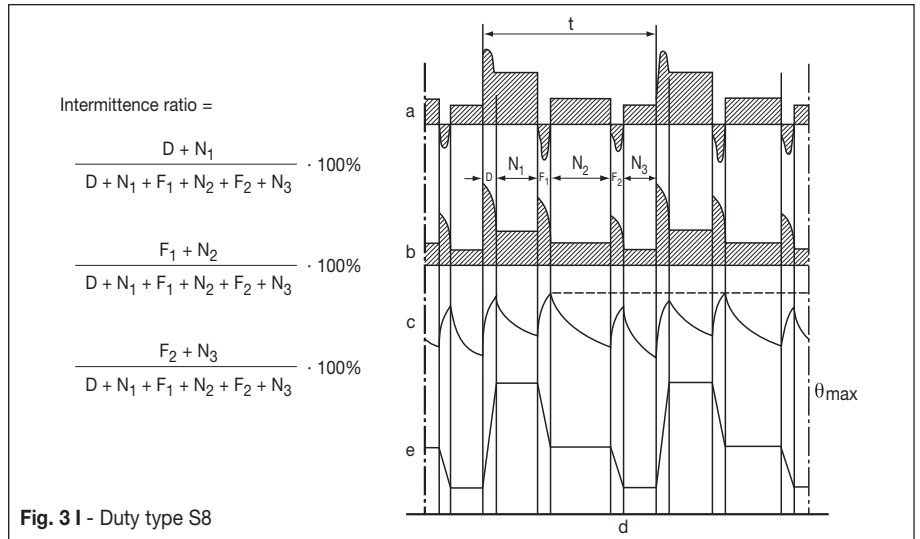
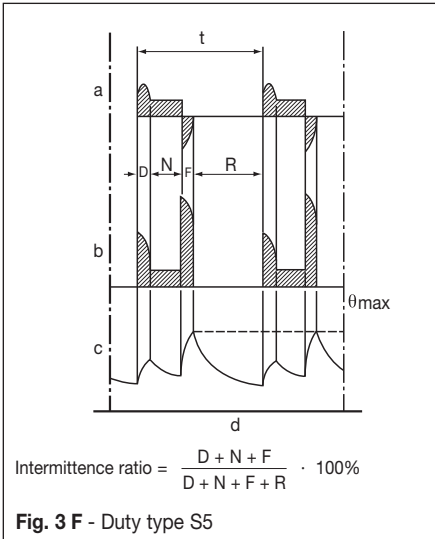

**Table 3 F - Simbology**

a	= Load
b	= Electrical losses
c	= Temperature
d	= Time
e	= Speed
t	= Cycle length
D	= Start-up or acceleration time
F, F <sub>1</sub> , F <sub>2</sub>	= Electrical braking time
N, N <sub>1</sub> , N <sub>2</sub> , N <sub>3</sub>	= Constant load operating time
L	= Variable load operating time
V	= No-load operating time
R	= Rest time
S	= Overload operating time
P	= Full load
θ <sub>max</sub>	= Maximum temperature reached during cycle

## 3.5 Connecting diagrams

### 3.5.1 Three-phase motors

#### 3.5.1 Three-phase motors

Single-speed motors are normally pre-arranged to be connected in star or delta method.

##### Star connection

Connecting together the W2, U2, V2 terminals (star point) and connecting to the mains the U1, V1, W1 terminals a star connection is obtained.

The phase current  $I_{ph}$  and the phase voltage  $U_{ph}$  are the following:

$$I_{ph} = I_n$$

$$U_{ph} = U_n / \sqrt{3}$$

where  $I_n$  the line current and  $U_n$  is the line voltage.

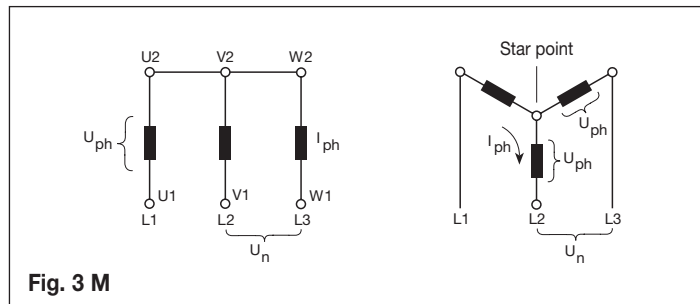

##### Delta connection

Connecting the end of each winding to the beginning of the next winding a delta connection is obtained.

The phase current  $I_{ph}$  and the phase voltage  $U_{ph}$  are the following:

$$I_{ph} = I_n / \sqrt{3}$$

$$U_{ph} = U_n$$

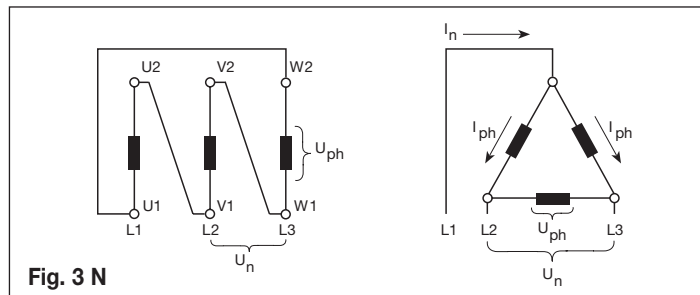

##### Star - Delta starting

The star-delta starting is an easy way to reduce the starting current and starting torque.

Motors can be started with the star-delta starting method whenever the supply voltage correspond to the rated voltage of the motors in delta connections.

##### Two speed motors

Standard two speed motors are designed for only one rated voltage and for direct starting.

When the speed ratio is 1/2 the standard motors have one winding (Dahlander connection).

For other speed ratios the motors have two different windings.

# 3.5

## 3.5.1

### 3.5.1 Three-phase motors

#### Connection for single speed motors:

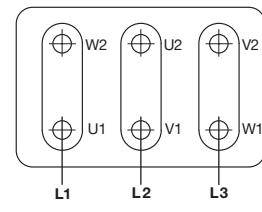
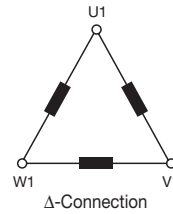
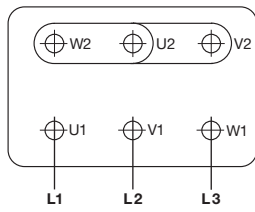
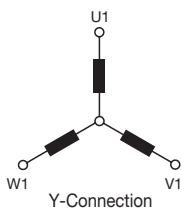

Number of pole: 2, 4, 6, 8 .....

Synchronous speed at 50 Hz: 3000, 1500, 1000, 750 .....

#### Two separate windings for two speed motors:

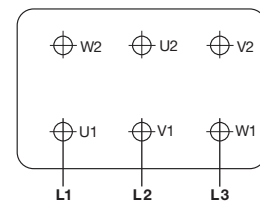
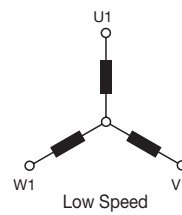
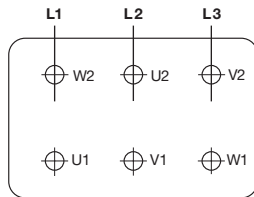
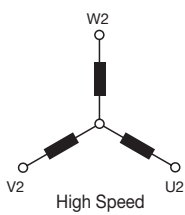

Number of pole: 2/6, 2/8, 4/6, 6/8

Synchronous speed at 50 Hz: 3000/1000, 3000/750, 1500/1000, 1000/750.

#### Dahlander system for two speed motors:

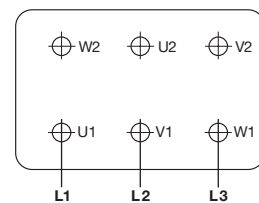
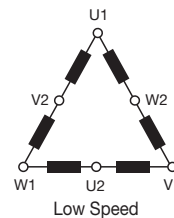
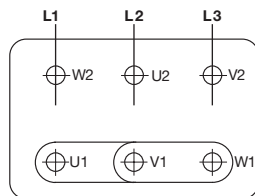
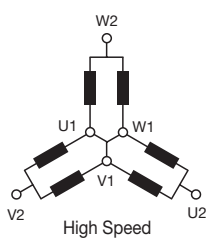

Number of pole: 2/4, 4/8

Synchronous speed at 50 Hz: 3000/1500, 1500/750.

Fig. 3 O - Three phase motors connecting diagrams



## 3.5

### 3.5.2 Single phase motors

#### 3.5.3 Additional terminal marking

### 3.5.2 Single phase motors

Single phase motors are designed for only one rated voltage.

They have two windings (starting and main winding) which have to be connected to the capacitor supplied with the motor.

The sense of rotation can be reversed according to the connecting diagram.

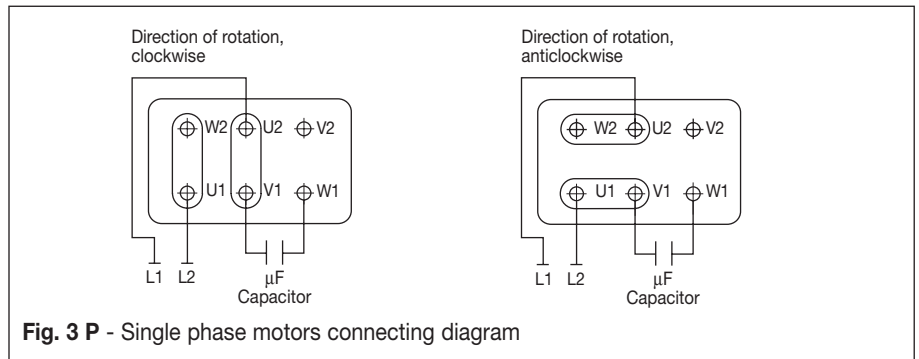

### 3.5.3 Additional terminal marking (IEC 60034-8)

Motors fitted with accessories are supplied with additional terminals, marked as indicated in Table 3 G.

**Table 3 G**

Marking	Nr. terminals	Additional terminal for:
TP1 - TP2 (warning)	2	Thermistor PTC (*)
TP3 - TP4 (switch off)	2	
R1 - R2 - R3 (I sensor)	3	Thermistor PT 100 with 3 wire
R4 - R5 - R6 (II sensor)	3	
R7 - R8 - R9 (III sensor)	3	
R11 - R12 - R13 (DE)	3	Thermistor PT 100 on bearing
R21 - R22 - R23 (NDE)	3	
TB1 - TB2 (warning)	2	Normally closed bi-metallic switch (**)
TB3 - TB4 (switch off)	2	
TB8 - TB9 (switch off)	2	Normally closed brake bi-metallic switch (**)
TM1 - TM2 (warning)	2	Normally open bi-metallic switch (**)
TM3 - TM4 (switch off)	2	
HE1 - HE2	2	Space heaters
U1 - U2	2	Single phase forced ventilation
U - V - W	2	Three phase forced ventilation
colours according manufacturer diagram	9	Encoder
CA1 - CA2	2	Capacitor
PE	1	Earth cable

(\*) U rated = 6V - max 30V - (\*\*) U rated = 250V

## 3.6 Protection devices

### 3.6 Protection devices

In order to protect the winding of a three-phase induction motor against thermal overloads, resulting in example from overloading and operation with only two phases, one of the following devices can be provided:

- **Bimetallic type device:**  
it consists of 2 motor protectors connected in series. The contact is normally closed; the disc opens when the windings temperature reaches limits dangerous for the insulation system. On request normally open device are available.

- **PTC temperature sensor** (thermistors):  
it consists of 3 sensors connected in series embedded in stator windings. Once reached the operating temperature, this device quickly changes the resistance; it must be connected to a suitable releasing device (supplied only on request).
- **PT 100 (RTD) thermometric resistors** (from size 132 and above).  
The resistance value of this device varies according to the windings temperature. They are particularly suitable for a continuous survey of the windings temperature.  
For a good survey at least two set of PT 100 are requested; they must be connected to their proper monitoring equipment (supplied only on request).

PTC and PT 100 also offer reliable protection for operating modes other than continuous operation, e. g. short-time operation, switching operation, longtime start-up as well as for reduced cooling air flow rates and high ambient temperatures.

Motors for operation with frequency converter are always supplied with PTC thermistor temperature detectors.

Above devices have their proper terminal block located inside main box.

Upon request also available with separate terminal box.

## 3.7 Frequency converter driven motors

### 3.7 Frequency converter driven motors

Motors with enclosures in protection type “d”, “de” are designed for variable speed drives.

Chapter 4.5 lists the electrical data in different working conditions of the Ex d, Ex de motors shown in this catalogue.

Specific type-approvals are needed for motors with protection type Ex e, while in many countries motors with protection type Ex nA are strongly restricted.

When using a squirrel cage “Ex d” motor with a frequency converter the following points must be taken into account in addition to the general selection criteria:

- The voltage (or current) fed by the frequency converter is not purely sinusoidal.

As a result it may increase the losses, vibration, and noise of the motor.

Futhermore, a change in the distribution of the losses may affect the motor temperature balance.

In every case, the motor must be correctly sized according to the instructions supplied with the selected frequency converter and with our technical data.

- In a frequency converter drive the actual operating speed of the motor may deviate considerably from its rated speed.

For higher speeds it must be ensured that the highest permissible speed of rotation of the motor, or the critical speed of the entire equipment, is not exceeded.

In addition, bearing lubrication and any ventilation noise suppression arrangements will require special attention.

- The torque values shown in this catalogue for motors with constant torque at frequencies over 60Hz can be stably supplied only if the motor has a delta connection.

For example, to stably achieve these values from a 230/400V 50Hz winding motor with a 400V 50Hz mains voltage supply, the motor must have a delta connection and, consequently, the inverter must be configured so that at 50Hz it supplies a voltage of 230V.

Vice-versa, with a star connection, the values listed can be supplied only for very short periods.

- Operating periods at a speed above 3600 1/min must never exceed 10% of the entire work cycle of the motor to ensure the bearings last accordingly.
- If the rated voltage is 690V or if there is a long feeding cable between the motor and the frequency converter, the insulation of the motor must be reinforced because of the occurring voltage peaks.

A correct earthing of the motor and the driven equipment is also important to avoid bearing currents and voltages.

The features of motors for use in constant torque and those for use in quadratic torque are indicated in section 4.5.

Section 4.5.1 contains graphs showing loading curves for the use of variable torque motors.

The reference torque value (Mn) is the value indicated in the tables in section 4.1.

## 4. Performance data

- 4.1 Three-phase motors, 1 speed
- 4.2 Three-phase motors, 2 speeds, for general purpose (constant torque)
- 4.3 Three-phase motors, 2 speeds, for centrifugal machines (quadratic torque)
- 4.4 Single-phase motors, 1 speed
- 4.5 Motors energized by inverter

## 4. *Données nominales*

- 4.1 *Moteurs triphasés, 1 vitesse*
- 4.2 *Moteurs triphasés, 2 vitesses, pour usage général (couple constant)*
- 4.3 *Moteurs triphasés, 2 vitesses, pour machines centrifuges (couple quadratique)*
- 4.4 *Moteurs monophasés, 1 vitesse*
- 4.5 *Moteurs alimentés par variateur*

## 4. Betriebsdaten

- 4.1 Drehstrom Motoren, 1 Drehzahl
- 4.2 Drehstrom Motoren, 2 Drehzahlen, für allgemeinen Gebrauch (konstantes Gegenmoment)
- 4.3 Drehstrom Motoren, 2 Drehzahlen, für Zentrifugalmaschinen (quadratisches Gegenmoment)
- 4.4 Einphasen Motoren, 1 Drehzahl
- 4.5 Motoren mit Umrichterversorgung

## 4. *Datos nominales*

- 4.1 *Motores trifásicos, 1 velocidad*
- 4.2 *Motores trifásicos, 2 velocidades, para uso general (par constante)*
- 4.3 *Motores trifásicos, 2 velocidades, para máquinas centrifugas (par cuadrático)*
- 4.4 *Motores monofásicos, 1 velocidad*
- 4.5 *Motores alimentados con inverter*

## 4. Dati nominali

- 4.1 Motori trifase, 1 velocità
- 4.2 Motori trifase, 2 velocità, per uso generale (coppia costante)
- 4.3 Motori trifase, 2 velocità, per macchine centrifughe (coppia quadratica)
- 4.4 Motori monofase, 1 velocità
- 4.5 Motori alimentati da inverter

GB F D E I	4.1	Three-phase motors	II 2G II 2GD	1	Speed	Rated data at	400 V 50 Hz	direct on line start	rpm 3000	GB F D E I
		Moteurs triphasés			Vitesse	Données nominales à		démarrage direct		
		Drehstrom Motoren			Drehzahl	Betriebsdaten bei		Direkteinschaltung		
		Motores trifásicos			Velocidad	Datos nominales		arranque directo		
		Motori trifase			Velocità	Dati nominali a		avviamento diretto		

Motor type	Rated output	Speed	Current	Efficiency	Power factor	Torque	Starting current	Starting torque	Maximum torque	Noise level	Moment of inertia	Mass	CESI Certificates	Class T
Moteur type	Puissance	Vitesse	Intensité	Rendement	Facteur de puissance	Couple	Intensité démarrage	Couple démarrage	Couple maximal	Niveau de bruit	Moment d'inertie	Masse	CESI Certificat	Classe T
Motor Typ	Leistung	Drehzahl	Strom	Wirkungsgrad	Leistungs-faktor	Moment	Anlauf-strom	Anlauf-moment	Kipp-moment	Schalldruck-pegel	Trägheits-moment	Masse	CESI Konformitäts-Bescheinigung	Klasse T
Tipo de motor	Potencia proporcionada	Velocidad	Corriente	Rendimiento	Factor de potencia	Par	Corriente de arranque	Par de arranque	Par máximo	Nivel de ruido	Momento de inercia	Peso	Certificados CESI	Clase T
Tipo motore	Potenza resa	Velocità	Corrente	Rendimento	Fattore potenza	Coppia	Corrente avviamento	Coppia avviamento	Coppia massima	Rumorosità	Momento d'inerzia	Massa	Certificato CESI	Classe T

IIB		IIC		P <sub>n</sub> [kW]	n [1/min]	I <sub>n</sub> <sup>D</sup> [A]	η [%]	cos φ	M <sub>n</sub> [Nm]	I <sub>a</sub> /I <sub>n</sub>	M <sub>a</sub> /M <sub>n</sub>	M <sub>m</sub> /M <sub>n</sub>	[dB(A)]		J ▼ [kgm <sup>2</sup> ]	m [kg]	IIB		IIC		◆
Ex d	Ex de	Ex d	Ex de										Lw	Lp			standard	★	standard	★	
AB30 63 A 2	AB35 63 A 2	AC30 63 A 2	AC35 63 A 2	0.18	2857	0.75	63	0.57	0.63	4.4	3.6	3.8	60	52	0.0001	16	01 ATEX 102	02 ATEX 044X	01 ATEX 103	02 ATEX 045X	4
AB30 63 B 2	AB35 63 B 2	AC30 63 B 2	AC35 63 B 2	0.25	2805	0.85	66	0.66	0.85	3.9	3.5	3.7	60	52	0.0001	16	01 ATEX 102	02 ATEX 044X	01 ATEX 103	02 ATEX 045X	4
AB30 71 A 2	AB35 71 A 2	AC30 71 A 2	AC35 71 A 2	0.37	2800	1.10	62	0.77	1.26	3.6	2.4	2.6	66	58	0.0004	19	01 ATEX 102	02 ATEX 044X	01 ATEX 103	02 ATEX 045X	4
AB30 71 B 2	AB35 71 B 2	AC30 71 B 2	AC35 71 B 2	0.55	2830	1.40	71	0.79	1.85	4.3	2.5	2.7	66	58	0.0004	19	01 ATEX 102	02 ATEX 044X	01 ATEX 103	02 ATEX 045X	4
AB30 80 A 2	AB35 80 A 2	AC30 80 A 2	AC35 80 A 2	0.75	2800	1.90	67	0.80	2.54	4.7	2.6	2.8	70	62	0.0006	26	01 ATEX 102	02 ATEX 044X	01 ATEX 103	02 ATEX 045X	4
AB30 80 B 2	AB35 80 B 2	AC30 80 B 2	AC35 80 B 2	1.10	2830	2.60	78	0.78	3.70	5.2	2.8	2.9	70	62	0.0008	26	01 ATEX 102	02 ATEX 044X	01 ATEX 103	02 ATEX 045X	4
AB30 90 S 2	AB35 90 S 2	AC30 90 S 2	AC35 90 S 2	1.50	2870	3.10	87	0.80	5.00	6.2	2.3	2.5	77	69	0.0012	33	01 ATEX 102	02 ATEX 044X	01 ATEX 103	02 ATEX 045X	4
AB30 90 L 2	AB35 90 L 2	AC30 90 L 2	AC35 90 L 2	2.20	2820	4.80	80	0.82	7.42	6.5	2.8	3.0	77	69	0.0015	33	01 ATEX 102	02 ATEX 044X	01 ATEX 103	02 ATEX 045X	4
AB30 100 LA 2	AB35 100 LA 2	AC30 100 LA 2	AC35 100 LA 2	3.00	2860	7.30	73	0.81	9.95	6.8	2.6	2.7	80	72	0.0029	46	01 ATEX 102	02 ATEX 044X	01 ATEX 103	02 ATEX 045X	4
AB30 112 M 2	AB35 112 M 2	AC30 112 M 2	AC35 112 M 2	4.00	2900	8.70	79	0.83	13.20	6.8	2.3	2.5	80	72	0.0074	65	02 ATEX 122	02 ATEX 124X	02 ATEX 123	02 ATEX 125X	4
AB30 132 SA 2	AB35 132 SA 2	AC30 132 SA 2	AC35 132 SA 2	5.50	2890	12.00	79	0.87	18.20	6.5	2.6	2.9	81	73	0.0124	95	02 ATEX 122	02 ATEX 124X	02 ATEX 123	02 ATEX 125X	4
AB30 132 SB 2	AB35 132 SB 2	AC30 132 SB 2	AC35 132 SB 2	7.50	2910	15.00	81	0.89	24.60	7.0	2.8	3.0	83	75	0.0150	95	02 ATEX 122	02 ATEX 124X	02 ATEX 123	02 ATEX 125X	4
AB30 132 MB 2	AB35 132 MB 2	AC30 132 MB 2	AC35 132 MB 2	9.20	2900	18.00	84	0.88	30.30	7.5	2.8	3.0	83	75	0.0178	105	02 ATEX 122	02 ATEX 124X	02 ATEX 123	02 ATEX 125X	4
AB30 132 ML 2	AB35 132 ML 2	AC30 132 ML 2	AC35 132 ML 2	11.00	2930	20.00	92	0.86	36.00	7.0	2.8	3.1	83	75	0.0216	105	02 ATEX 122	02 ATEX 124X	02 ATEX 123	02 ATEX 125X	4
AB30 160 MA 2	AB35 160 MA 2	AC30 160 MA 2	AC35 160 MA 2	11.00	2930	20.60	87	0.89	36.22	6.4	2.5	2.8	84	76	0.0360	180	02 ATEX 122	02 ATEX 124X	02 ATEX 123	02 ATEX 125X	4
AB30 160 MB 2	AB35 160 MB 2	AC30 160 MB 2	AC35 160 MB 2	15.00	2945	26.80	91	0.90	48.79	7.0	2.7	3.0	84	76	0.0463	180	02 ATEX 122	02 ATEX 124X	02 ATEX 123	02 ATEX 125X	4
AB30 160 L 2	AB35 160 L 2	AC30 160 L 2	AC35 160 L 2	18.50	2945	32.80	90	0.91	60.24	7.0	2.5	3.0	84	76	0.0534	195	02 ATEX 122	02 ATEX 124X	02 ATEX 123	02 ATEX 125X	4
AB30 180 M 2	AB35 180 M 2	AC30 180 M 2	AC35 180 M 2	22.00	2955	40.00	90	0.89	71.20	7.6	2.0	2.7	83	74	0.0818	230	06 ATEX 074	Pending	06 ATEX 073	Pending	4
AB30 200 LA 2	AB35 200 LA 2	AC30 200 LA 2	AC35 200 LA 2	30.00	2975	55.00	92	0.86	96.43	8.5	3.5	3.7	87	77	0.1625	285	06 ATEX 074	Pending	06 ATEX 073	Pending	4
AB30 200 LB 2	AB35 200 LB 2	AC30 200 LB 2	AC35 200 LB 2	37.00	2965	67.00	94	0.88	119.10	7.9	2.1	2.5	87	77	0.1947	305	06 ATEX 074	Pending	06 ATEX 073	Pending	4
AB30 225 M 2	AB35 225 M 2	AC30 225 M 2	AC35 225 M 2	45.00	2980	82.00	93	0.86	144.20	9.0	2.6	3.0	89	79	0.2902	385	06 ATEX 074	Pending	06 ATEX 073	Pending	4
AB30 250 M 2	AB35 250 M 2	AC30 250 M 2	AC35 250 M 2	55.00	2980	98.00	93	0.87	176.50	7.3	2.5	2.8	90	79	0.4197	505	06 ATEX 074	Pending	06 ATEX 073	Pending	4
AB30 280 S 2	AB35 280 S 2	AC30 280 S 2	AC35 280 S 2	75.00	2980	132.00	95	0.87	240.30	7.3	2.7	3.3	88	76	0.5200	857	08 ATEX 012	---	00 ATEX 053	01 ATEX 003X	4
AB30 280 M 2	AB35 280 M 2	AC30 280 M 2	AC35 280 M 2	90.00	2985	165.00	90	0.88	288.00	8.6	3.1	3.8	88	76	0.6300	896	08 ATEX 012	---	00 ATEX 053	01 ATEX 003X	4
AB30 315 S 2	AB35 315 S 2	AC30 315 S 2	AC35 315 S 2	110.00	2980	193.00	92	0.90	352.00	8.2	3.0	3.9	90	76	0.7000	932	08 ATEX 012	---	00 ATEX 053	01 ATEX 003X	4
AB30 315 M 2	AB35 315 M 2	AC30 315 M 2	AC35 315 M 2	132.00	2975	229.00	93	0.90	423.70	7.9	2.5	3.3	90	76	0.7500	948	08 ATEX 012	---	00 ATEX 053	01 ATEX 003X	4
AB30 315 LA 2	AB35 315 LA 2	AC30 315 LA 2	AC35 315 LA 2	132.00	2984	222.00	94	0.92	422.47	7.0	2.0	2.3	99	85	1.8800	1350	08 ATEX 021	---	07 ATEX 073	---	4
AB30 315 LB 2	AB35 315 LB 2	AC30 315 LB 2	AC35 315 LB 2	160.00	2984	269.00	94.5	0.91	512.21	7.0	1.7	2.0	99	85	2.2500	1440	08 ATEX 021	---	07 ATEX 073	---	4
AB30 315 LC 2	AB35 315 LC 2	AC30 315 LC 2	AC35 315 LC 2	200.00	2983	332.00	95.2	0.91	640.30	7.4	1.7	2.0	99	85	2.7900	1560	08 ATEX 021	---	07 ATEX 073	---	4

$$I'_n = I_n \cdot \frac{400}{U}$$

(I<sub>n</sub> = current at U' Volt);  
(I<sub>n</sub> = intensité à U' Volt);  
(I<sub>n</sub> = Strom mit U' Volt);  
(I<sub>n</sub> = corriente de U' Voltios);  
(I<sub>n</sub> = corrente a U' Volt);

$$J = \frac{PD^2}{4}$$

★ Versions that need special installation solutions  
*Versions qui demandent des mesures particulières pour l'installation*  
Ausführungen, die bei der Installation besondere Vorsichtsmaßnahmen erfordern  
*Versiones que requieren precauciones especiales de instalación*  
Versioni che richiedono particolari accorgimenti di installazione

◆ T3, T5 and T6 see table 1B  
T3, T5 et T6 voir tableau 1B  
T3, T5 und T6 siehe Tabelle 1B  
T3, T5 y T6 véase tabla 1B  
T3, T5 e T6 vedi tabella 1B

GB F D E I	4. 4.1	Three-phase motors	II 2G II 2GD	1	Speed	Rated data at	400 V 50 Hz	direct on line start	rpm 1500	GB F D E I
		Moteurs triphasés			Vitesse	Données nominales à		démarrage direct		
		Drehstrom Motoren			Drehzahl	Betriebsdaten bei		Direkteinschaltung		
		Motores trifásicos			Velocidad	Datos nominales		arranque directo		
		Motori trifase			Velocità	Dati nominali a		avviamento diretto		

Motor type	Rated output	Speed	Current	Efficiency	Power factor	Torque	Starting current	Starting torque	Maximum torque	Noise level	Moment of inertia	Mass	CESI Certificates	Class T
Moteur type	Puissance	Vitesse	Intensité	Rendement	Facteur de puissance	Couple	Intensité démarrage	Couple démarrage	Couple maximal	Niveau de bruit	Moment d'inertie	Masse	CESI Certificat	Classe T
Motor Typ	Leistung	Drehzahl	Strom	Wirkungsgrad	Leistungs-faktor	Moment	Anlauf-strom	Anlauf-moment	Kipp-moment	Schalldruck-pegel	Trägheits-moment	Masse	CESI Konformitäts-Bescheinigung	Klasse T
Tipo de motor	Potencia proporcionada	Velocidad	Corriente	Rendimiento	Factor de potencia	Par	Corriente de arranque	Par de arranque	Par máximo	Nivel de ruido	Momento de inercia	Peso	Certificados CESI	Clase T
Tipo motore	Potenza resa	Velocità	Corrente	Rendimento	Fattore potenza	Coppia	Corrente avviamento	Coppia avviamento	Coppia massima	Rumorosità	Momento d'inertzia	Massa	Certificato CESI	Classe T

IIB		IIC		P <sub>n</sub> [kW]	n [1/min]	I <sub>n</sub> <sup>D</sup> [A]	η [%]	cos φ	M <sub>n</sub> [Nm]	I <sub>a</sub> /I <sub>n</sub>	M <sub>a</sub> /M <sub>n</sub>	M <sub>M</sub> /M <sub>n</sub>	[dB(A)]		J ▼ [kgm <sup>2</sup> ]	m [kg]	IIB		IIC		◆
Ex d	Ex de	Ex d	Ex de										Lw	Lp			standard	★	standard	★	
AB30 63 A 4	AB35 63 A 4	AC30 63 A 4	AC35 63 A 4	0.12	1380	0.62	58	0.55	0.93	4.5	2.3	2.5	52	44	0.0002	16	01 ATEX 102	02 ATEX 044X	01 ATEX 103	02 ATEX 045X	4
AB30 63 B 4	AB35 63 B 4	AC30 63 B 4	AC35 63 B 4	0.18	1340	0.67	62	0.65	1.28	4.2	2.3	2.5	52	44	0.0002	16	01 ATEX 102	02 ATEX 044X	01 ATEX 103	02 ATEX 045X	4
AB30 71 A 4	AB35 71 A 4	AC30 71 A 4	AC35 71 A 4	0.25	1372	0.80	60	0.78	1.72	3.1	2.2	2.6	56	48	0.0006	19	01 ATEX 102	02 ATEX 044X	01 ATEX 103	02 ATEX 045X	4
AB30 71 B 4	AB35 71 B 4	AC30 71 B 4	AC35 71 B 4	0.37	1390	1.10	69	0.72	2.53	3.5	2.2	2.7	56	48	0.0009	19	01 ATEX 102	02 ATEX 044X	01 ATEX 103	02 ATEX 045X	4
AB30 80 A 4	AB35 80 A 4	AC30 80 A 4	AC35 80 A 4	0.55	1380	1.60	69	0.71	3.86	4.0	2.3	2.5	59	51	0.0009	26	01 ATEX 102	02 ATEX 044X	01 ATEX 103	02 ATEX 045X	4
AB30 80 B 4	AB35 80 B 4	AC30 80 B 4	AC35 80 B 4	0.75	1400	2.00	77	0.70	5.10	4.0	2.3	2.6	59	51	0.0013	26	01 ATEX 102	02 ATEX 044X	01 ATEX 103	02 ATEX 045X	4
AB30 90 S 4	AB35 90 S 4	AC30 90 S 4	AC35 90 S 4	1.10	1400	2.80	79	0.74	7.72	4.1	2.0	2.4	62	54	0.0020	33	01 ATEX 102	02 ATEX 044X	01 ATEX 103	02 ATEX 045X	4
AB30 90 L 4	AB35 90 L 4	AC30 90 L 4	AC35 90 L 4	1.50	1420	3.60	76	0.79	10.10	5.0	2.3	2.5	62	54	0.0026	33	01 ATEX 102	02 ATEX 044X	01 ATEX 103	02 ATEX 045X	4
AB30 100 LA 4	AB35 100 LA 4	AC30 100 LA 4	AC35 100 LA 4	2.20	1427	5.25	79	0.77	14.78	4.5	2.2	2.4	63	55	0.0043	46	01 ATEX 102	02 ATEX 044X	01 ATEX 103	02 ATEX 045X	4
AB30 100 LB 4	AB35 100 LB 4	AC30 100 LB 4	AC35 100 LB 4	3.00	1436	6.83	83	0.77	20.00	5.1	2.8	3.1	63	55	0.0053	46	01 ATEX 102	02 ATEX 044X	01 ATEX 103	02 ATEX 045X	4
AB30 112 M 4	AB35 112 M 4	AC30 112 M 4	AC35 112 M 4	4.00	1440	8.20	87	0.83	27.24	5.5	2.1	2.9	68	60	0.0103	65	02 ATEX 122	02 ATEX 124X	02 ATEX 123	02 ATEX 125X	4
AB30 132 SB 4	AB35 132 SB 4	AC30 132 SB 4	AC35 132 SB 4	5.50	1455	11.60	88	0.78	36.17	6.3	2.4	2.8	72	64	0.0250	95	02 ATEX 122	02 ATEX 124X	02 ATEX 123	02 ATEX 125X	4
AB30 132 MB 4	AB35 132 MB 4	AC30 132 MB 4	AC35 132 MB 4	7.50	1450	16.50	85	0.77	49.40	6.7	2.5	3.4	75	67	0.0324	95	02 ATEX 122	02 ATEX 124X	02 ATEX 123	02 ATEX 125X	4
AB30 132 ML 4	AB35 132 ML 4	AC30 132 ML 4	AC35 132 ML 4	8.80	1455	18.50	87	0.79	57.59	6.8	2.5	3.5	75	67	0.0405	105	02 ATEX 122	02 ATEX 124X	02 ATEX 123	02 ATEX 125X	4
AB30 160 MB 4	AB35 160 MB 4	AC30 160 MB 4	AC35 160 MB 4	11.00	1470	23.00	89	0.78	72.00	6.2	2.5	3.0	77	69	0.0627	180	02 ATEX 122	02 ATEX 124X	02 ATEX 123	02 ATEX 125X	4
AB30 160 L 4	AB35 160 L 4	AC30 160 L 4	AC35 160 L 4	15.00	1470	30.00	92	0.79	97.50	5.9	2.5	3.0	77	69	0.0801	195	02 ATEX 122	02 ATEX 124X	02 ATEX 123	02 ATEX 125X	4
AB30 180 M 4	AB35 180 M 4	AC30 180 M 4	AC35 180 M 4	18.50	1470	39.00	91	0.75	120.20	6.0	3.2	3.0	79	70	0.1236	230	06 ATEX 074	Pending	06 ATEX 073	Pending	4
AB30 180 L 4	AB35 180 L 4	AC30 180 L 4	AC35 180 L 4	22.00	1470	44.00	92	0.78	143.00	7.0	2.3	2.5	79	70	0.1493	245	06 ATEX 074	Pending	06 ATEX 073	Pending	4
AB30 200 LB 4	AB35 200 LB 4	AC30 200 LB 4	AC35 200 LB 4	30.00	1475	54.00	95	0.85	194.60	6.6	2.7	2.9	82	72	0.2456	305	06 ATEX 074	Pending	06 ATEX 073	Pending	4
AB30 225 S 4	AB35 225 S 4	AC30 225 S 4	AC35 225 S 4	37.00	1480	70.00	95	0.81	238.60	7.1	2.7	3.0	84	73	0.3737	360	06 ATEX 074	Pending	06 ATEX 073	Pending	4
AB30 225 M 4	AB35 225 M 4	AC30 225 M 4	AC35 225 M 4	45.00	1480	82.00	95	0.83	290.50	6.2	2.4	2.8	84	73	0.4479	385	06 ATEX 074	Pending	06 ATEX 073	Pending	4
AB30 250 M 4	AB35 250 M 4	AC30 250 M 4	AC35 250 M 4	55.00	1485	96.00	94	0.88	354.70	7.2	2.9	2.9	86	75	0.7673	540	06 ATEX 074	Pending	06 ATEX 073	Pending	4
AB30 280 S 4	AB35 280 S 4	AC30 280 S 4	AC35 280 S 4	75.00	1480	136.00	93	0.86	483.95	6.3	2.2	2.4	82	70	0.9500	890	08 ATEX 012	---	00 ATEX 053	01 ATEX 003X	4
AB30 280 M 4	AB35 280 M 4	AC30 280 M 4	AC35 280 M 4	90.00	1485	163.00	93	0.86	578.00	7.3	3.0	3.1	82	70	1.1200	916	08 ATEX 012	---	00 ATEX 053	01 ATEX 003X	4
AB30 315 S 4	AB35 315 S 4	AC30 315 S 4	AC35 315 S 4	110.00	1485	199.00	94	0.85	705.00	8.3	3.2	3.5	85	71	1.2700	971	08 ATEX 012	---	00 ATEX 053	01 ATEX 003X	4
AB30 315 M 4	AB35 315 M 4	AC30 315 M 4	AC35 315 M 4	132.00	1480	239.00	93	0.83	851.80	7.1	2.3	2.3	85	71	1.3300	984	08 ATEX 012	---	00 ATEX 053	01 ATEX 003X	4
AB30 315 LA 4	AB35 315 LA 4	AC30 315 LA 4	AC35 315 LA 4	132.00	1491	236.00	95	0.85	845.00	7.2	2.0	2.4	90	76	3.7200	1200	08 ATEX 021	---	07 ATEX 073	---	4
AB30 315 LB 4	AB35 315 LB 4	AC30 315 LB 4	AC35 315 LB 4	160.00	1488	282.00	95.5	0.86	1027.00	7.1	2.0	2.3	90	76	4.1100	1465	08 ATEX 021	---	07 ATEX 073	---	4
AB30 315 LC 4	AB35 315 LC 4	AC30 315 LC 4	AC35 315 LC 4	200.00	1488	354.00	95.2	0.86	1285.00	9.0	2.6	2.9	90	76	5.2100	1650	08 ATEX 021	---	07 ATEX 073	---	4

$$I_n^D = I_n \cdot \frac{400}{U}$$

(I<sub>n</sub><sup>D</sup> = current at U' Volt);  
(I<sub>n</sub><sup>D</sup> = intensité à U' Volt);  
(I<sub>n</sub><sup>D</sup> = Strom mit U' Volt);  
(I<sub>n</sub><sup>D</sup> = corriente de U' Voltios);  
(I<sub>n</sub><sup>D</sup> = corrente a U' Volt);

$$J = \frac{PD^2}{4}$$

★ Versions that need special installation solutions  
*Versions qui demandent des mesures particulières pour l'installation*  
Ausführungen, die bei der Installation besondere Vorsichtsmaßnahmen erfordern  
*Versiones que requieren precauciones especiales de instalación*  
Versioni che richiedono particolari accorgimenti di installazione

◆ T3, T5 and T6 see table 1B  
T3, T5 et T6 voir tableau 1B  
T3, T5 und T6 siehe Tabelle 1B  
T3, T5 y T6 véase tabla 1B  
T3, T5 e T6 vedi tabella 1B



GB F D E I	4. 4.1	Three-phase motors	II 2G II 2GD	1	Speed	Rated data at	400 V 50 Hz	direct on line start	rpm 1000	GB F D E I
		Moteurs triphasés			Vitesse	Données nominales à		démarrage direct		
		Drehstrom Motoren			Drehzahl	Betriebsdaten bei		Direkteinschaltung		
		Motores trifásicos			Velocidad	Datos nominales		arranque directo		
		Motori trifase			Velocità	Dati nominali a		avviamento diretto		

Motor type	Rated output	Speed	Current	Efficiency	Power factor	Torque	Starting current	Starting torque	Maximum torque	Noise level	Moment of inertia	Mass	CESI Certificates	Class T
Moteur type	Puissance	Vitesse	Intensité	Rendement	Facteur de puissance	Couple	Intensité de démarrage	Couple de démarrage	Couple maximal	Niveau de bruit	Moment d'inertie	Masse	CESI Certificat	Classe T
Motor Typ	Leistung	Drehzahl	Strom	Wirkungsgrad	Leistungs-faktor	Moment	Anlauf-strom	Anlauf-moment	Kipp-moment	Schalldruck-pegel	Trägheits-moment	Masse	CESI Konformitäts-Bescheinigung	Klasse T
Tipo de motor	Potencia proporcionada	Velocidad	Corriente	Rendimiento	Factor de potencia	Par	Corriente de arranque	Par de arranque	Par máximo	Nivel de ruido	Momento de inercia	Peso	Certificados CESI	Clase T
Tipo motore	Potenza resa	Velocità	Corrente	Rendimento	Fattore potenza	Coppia	Corrente avviamento	Coppia avviamento	Coppia massima	Rumorosità	Momento d'inertzia	Massa	Certificato CESI	Classe T

IIB		IIC		P <sub>n</sub> [kW]	n [1/min]	I <sub>n</sub> [A]	η [%]	cos φ	M <sub>n</sub> [Nm]	I <sub>a</sub> /I <sub>n</sub>	M <sub>a</sub> /M <sub>n</sub>	M <sub>m</sub> /M <sub>n</sub>	[dB(A)]		J ▼ [kgm <sup>2</sup> ]	m [kg]	IIB		IIC		◆
Ex d	Ex de	Ex d	Ex de										L <sub>w</sub>	L <sub>p</sub>			standard	★	standard	★	
AB30 63 B 6	AB35 63 B 6	AC30 63 B 6	AC35 63 B 6	0.09	850	0.65	38	0.52	1.00	2.0	2.3	2.2	48	40	0.0002	16	01 ATEX 102	02 ATEX 044X	01 ATEX 103	02 ATEX 045X	4
AB30 71 A 6	AB35 71 A 6	AC30 71 A 6	AC35 71 A 6	0.18	945	0.92	55	0.51	1.82	3.7	3.7	3.5	50	42	0.0007	19	01 ATEX 102	02 ATEX 044X	01 ATEX 103	02 ATEX 045X	4
AB30 71 B 6	AB35 71 B 6	AC30 71 B 6	AC35 71 B 6	0.26	918	1.00	60	0.63	2.71	3.4	2.6	2.6	50	42	0.0010	19	01 ATEX 102	02 ATEX 044X	01 ATEX 103	02 ATEX 045X	4
AB30 80 A 6	AB35 80 A 6	AC30 80 A 6	AC35 80 A 6	0.37	930	1.60	58	0.58	3.80	3.1	2.9	3.2	53	45	0.0022	26	01 ATEX 102	02 ATEX 044X	01 ATEX 103	02 ATEX 045X	4
AB30 80 B 6	AB35 80 B 6	AC30 80 B 6	AC35 80 B 6	0.55	930	1.80	70	0.65	5.79	2.8	2.0	2.1	53	45	0.0027	26	01 ATEX 102	02 ATEX 044X	01 ATEX 103	02 ATEX 045X	4
AB30 90 S 6	AB35 90 S 6	AC30 90 S 6	AC35 90 S 6	0.75	910	2.20	70	0.71	7.90	3.0	1.8	2.1	54	46	0.0034	33	01 ATEX 102	02 ATEX 044X	01 ATEX 103	02 ATEX 045X	4
AB30 90 L 6	AB35 90 L 6	AC30 90 L 6	AC35 90 L 6	1.10	935	3.20	86	0.59	11.59	3.4	2.0	2.2	54	46	0.0049	33	01 ATEX 102	02 ATEX 044X	01 ATEX 103	02 ATEX 045X	4
AB30 100 LB 6	AB35 100 LB 6	AC30 100 LB 6	AC35 100 LB 6	1.50	950	3.80	76	0.75	15.10	4.2	2.0	2.3	63	55	0.0088	46	01 ATEX 102	02 ATEX 044X	01 ATEX 103	02 ATEX 045X	4
AB30 112 M 6	AB35 112 M 6	AC30 112 M 6	AC35 112 M 6	2.20	960	6.20	80	0.65	21.92	5.2	2.3	2.1	65	57	0.0172	65	02 ATEX 122	02 ATEX 124X	02 ATEX 123	02 ATEX 125X	4
AB30 132 SB 6	AB35 132 SB 6	AC30 132 SB 6	AC35 132 SB 6	3.00	950	8.50	71	0.72	30.20	5.8	1.4	1.9	68	60	0.0323	95	02 ATEX 122	02 ATEX 124X	02 ATEX 123	02 ATEX 125X	4
AB30 132 MB 6	AB35 132 MB 6	AC30 132 MB 6	AC35 132 MB 6	4.00	970	9.50	81	0.75	39.40	6.1	1.7	1.9	68	60	0.0395	95	02 ATEX 122	02 ATEX 124X	02 ATEX 123	02 ATEX 125X	4
AB30 132 ML 6	AB35 132 ML 6	AC30 132 ML 6	AC35 132 ML 6	5.50	960	12.00	86	0.77	54.90	4.8	1.8	2.0	68	60	0.0506	105	02 ATEX 122	02 ATEX 124X	02 ATEX 123	02 ATEX 125X	4
AB30 160 MB 6	AB35 160 MB 6	AC30 160 MB 6	AC35 160 MB 6	7.50	950	16.00	84	0.81	75.40	5.9	1.6	2.0	72	64	0.0919	180	02 ATEX 122	02 ATEX 124X	02 ATEX 123	02 ATEX 125X	4
AB30 160 L 6	AB35 160 L 6	AC30 160 L 6	AC35 160 L 6	11.00	950	23.00	81	0.85	110.90	6.2	1.7	2.0	72	64	0.1218	195	02 ATEX 122	02 ATEX 124X	02 ATEX 123	02 ATEX 125X	4
AB30 180 L 6	AB35 180 L 6	AC30 180 L 6	AC35 180 L 6	15.00	960	29.00	88	0.86	149.20	5.4	1.7	2.2	76	67	0.2263	245	06 ATEX 074	Pending	06 ATEX 073	Pending	4
AB30 200 LA 6	AB35 200 LA 6	AC30 200 LA 6	AC35 200 LA 6	18.50	975	38.00	91	0.77	181.50	5.9	1.6	2.1	79	69	0.2986	295	06 ATEX 074	Pending	06 ATEX 073	Pending	4
AB30 200 LB 6	AB35 200 LB 6	AC30 200 LB 6	AC35 200 LB 6	22.00	980	44.00	92	0.78	215.00	6.1	1.6	2.1	79	69	0.3064	305	06 ATEX 074	Pending	06 ATEX 073	Pending	4
AB30 225 M 6	AB35 225 M 6	AC30 225 M 6	AC35 225 M 6	30.00	985	61.00	92	0.78	291.00	5.8	2.0	2.5	81	70	0.7617	385	06 ATEX 074	Pending	06 ATEX 073	Pending	4
AB30 250 M 6	AB35 250 M 6	AC30 250 M 6	AC35 250 M 6	37.00	990	72.00	94	0.79	358.00	5.2	2.0	2.4	81	70	1.0475	520	06 ATEX 074	Pending	06 ATEX 073	Pending	4
AB30 280 S 6	AB35 280 S 6	AC30 280 S 6	AC35 280 S 6	45.00	982	90.50	89	0.80	436.29	4.9	2.5	2.8	77	65	1.1400	873	08 ATEX 012	---	00 ATEX 053	01 ATEX 003X	4
AB30 280 M 6	AB35 280 M 6	AC30 280 M 6	AC35 280 M 6	55.00	980	109.00	91	0.81	535.00	4.7	2.3	2.4	77	65	1.3600	909	08 ATEX 012	---	00 ATEX 053	01 ATEX 003X	4
AC30 315 S 6	AC35 315 S 6	AC30 315 S 6	AC35 315 S 6	75.00	990	147.20	94	0.79	724.00	6.3	2.6	2.7	79	65	1.6300	965	08 ATEX 012	---	00 ATEX 053	01 ATEX 003X	4
AC30 315 M 6	AC35 315 M 6	AC30 315 M 6	AC35 315 M 6	90.00	990	175.00	94	0.79	871.00	4.4	1.8	1.8	79	65	1.8300	991	08 ATEX 012	---	00 ATEX 053	01 ATEX 003X	4
AB30 315 LA 6	AB35 315 LA 6	AC30 315 LA 6	AC35 315 LA 6	90.00	994	167.60	94	0.83	865.00	5.3	2.2	2.3	84	70	5.7300	1380	08 ATEX 021	---	07 ATEX 073	---	4
AB30 315 LB 6	AB35 315 LB 6	AC30 315 LB 6	AC35 315 LB 6	110.00	994	205.00	94	0.83	1057.00	5.3	2.2	2.3	84	70	6.9400	1460	08 ATEX 021	---	07 ATEX 073	---	4
AB30 315 LC 6	AB35 315 LC 6	AC30 315 LC 6	AC35 315 LC 6	132.00	995	243.00	94	0.83	1264.00	5.3	2.1	2.2	84	70	8.4500	1530	08 ATEX 021	---	07 ATEX 073	---	4

$$I'_n = I_n \cdot \frac{400}{U}$$

(I'<sub>n</sub> = current at U' Volt);  
(I'<sub>n</sub> = intensité à U' Volt);  
(I'<sub>n</sub> = Strom mit U' Volt);  
(I'<sub>n</sub> = corriente de U' Voltios);  
(I'<sub>n</sub> = corrente a U' Volt);

$$J = \frac{PD^2}{4}$$

★ Versions that need special installation solutions  
*Versions qui demandent des mesures particulières pour l'installation*  
Ausführungen, die bei der Installation besondere Vorsichtsmaßnahmen erfordern  
*Versiones que requieren precauciones especiales de instalación*  
Versioni che richiedono particolari accorgimenti di installazione

◆ T3, T5 and T6 see table 1B  
T3, T5 et T6 voir tableau 1B  
T3, T5 und T6 siehe Tabelle 1B  
T3, T5 y T6 véase tabla 1B  
T3, T5 e T6 vedi tabella 1B

GB F D E I	4. 4.1	Three-phase motors	II 2G II 2GD	1	Speed	Rated data at	400 V 50 Hz	direct on line start	rpm 750	GB F D E I	
		Moteurs triphasés			Vitesse	Données nominales à		démarrage direct			tours/min
		Drehstrom Motoren			Drehzahl	Betriebsdaten bei		Direkteinschaltung			U/min
		Motores trifásicos			Velocidad	Datos nominales		arranque directo			rev/min
		Motori trifase			Velocità	Dati nominali a		avviamento diretto			giri/min

Motor type	Rated output	Speed	Current	Efficiency	Power factor	Torque	Starting current	Starting torque	Maximum torque	Noise level	Moment of inertia	Mass	CESI Certificates	Class T
Moteur type	Puissance	Vitesse	Intensité	Rendement	Facteur de puissance	Couple	Intensité démarrage	Couple démarrage	Couple maximal	Niveau de bruit	Moment d'inertie	Masse	CESI Certificat	Classe T
Motor Typ	Leistung	Drehzahl	Strom	Wirkungsgrad	Leistungs-faktor	Moment	Anlauf-strom	Anlauf-moment	Kipp-moment	Schalldruck-pegel	Trägheits-moment	Masse	CESI Konformitäts-Bescheinigung	Klasse T
Tipo de motor	Potencia proporcionada	Velocidad	Corriente	Rendimiento	Factor de potencia	Par	Corriente de arranque	Par de arranque	Par máximo	Nivel de ruido	Momento de inercia	Peso	Certificados CESI	Clase T
Tipo motore	Potenza resa	Velocità	Corrente	Rendimento	Fattore potenza	Coppia	Corrente avviamento	Coppia avviamento	Coppia massima	Rumorosità	Momento d'inerzia	Massa	Certificato CESI	Classe T

IIB		IIC		P <sub>n</sub> [kW]	n [1/min]	I <sub>n</sub> <sup>▷</sup> [A]	η [%]	cos φ	M <sub>n</sub> [Nm]	I <sub>a</sub> /I <sub>n</sub>	M <sub>a</sub> /M <sub>n</sub>	M <sub>m</sub> /M <sub>n</sub>	[dB(A)]		J ▼ [kgm <sup>2</sup> ]	m [kg]	IIB		IIC		◆
Ex d	Ex de	Ex d	Ex de										Lw	Lp			standard	★	standard	★	
AB30 63 B 8	AB35 63 B 8	AC30 63 B 8	AC35 63 B 8	0.05	590	0.44	27	0.60	0.79	1.59	1.6	1.8	47	39	0.0002	16	01 ATEX 102	02 ATEX 044X	01 ATEX 103	02 ATEX 045X	4
AB30 71 B 8	AB35 71 B 8	AC30 71 B 8	AC35 71 B 8	0.15	600	0.57	54	0.75	2.54	2.10	1.3	1.5	48	40	0.0010	19	01 ATEX 102	02 ATEX 044X	01 ATEX 103	02 ATEX 045X	4
AB30 80 A 8	AB35 80 A 8	AC30 80 A 8	AC35 80 A 8	0.18	705	0.97	55	0.52	2.63	3.40	1.9	2.0	49	41	0.0022	26	01 ATEX 102	02 ATEX 044X	01 ATEX 103	02 ATEX 045X	4
AB30 80 B 8	AB35 80 B 8	AC30 80 B 8	AC35 80 B 8	0.25	690	1.00	61	0.60	3.53	3.30	1.4	1.7	49	41	0.0027	26	01 ATEX 102	02 ATEX 044X	01 ATEX 103	02 ATEX 045X	4
AB30 90 S 8	AB35 90 S 8	AC30 90 S 8	AC35 90 S 8	0.37	680	1.30	75	0.55	5.20	2.20	1.5	1.8	53	45	0.0034	33	01 ATEX 102	02 ATEX 044X	01 ATEX 103	02 ATEX 045X	4
AB30 90 L 8	AB35 90 L 8	AC30 90 L 8	AC35 90 L 8	0.55	680	1.90	80	0.52	7.73	2.10	1.5	1.8	53	45	0.0049	33	01 ATEX 102	02 ATEX 044X	01 ATEX 103	02 ATEX 045X	4
AB30 100 LA 8	AB35 100 LA 8	AC30 100 LA 8	AC35 100 LA 8	0.75	720	2.90	67	0.56	9.90	3.40	2.0	2.2	60	52	0.0088	46	01 ATEX 102	02 ATEX 044X	01 ATEX 103	02 ATEX 045X	4
AB30 100 LB 8	AB35 100 LB 8	AC30 100 LB 8	AC35 100 LB 8	1.10	675	3.10	75	0.68	15.50	2.70	1.8	2.2	60	52	0.0088	46	01 ATEX 102	02 ATEX 044X	01 ATEX 103	02 ATEX 045X	4
AB30 112 M 8	AB35 112 M 8	AC30 112 M 8	AC35 112 M 8	1.50	720	4.40	76	0.65	20.00	4.10	1.9	2.2	62	54	0.0172	65	02 ATEX 122	02 ATEX 124X	02 ATEX 123	02 ATEX 125X	4
AB30 132 SB 8	AB35 132 SB 8	AC30 132 SB 8	AC35 132 SB 8	2.20	720	6.50	75	0.66	29.20	4.00	1.8	2.3	66	58	0.0323	95	02 ATEX 122	02 ATEX 124X	02 ATEX 123	02 ATEX 125X	4
AB30 132 ML 8	AB35 132 ML 8	AC30 132 ML 8	AC35 132 ML 8	3.00	720	8.50	82	0.63	40.25	3.90	1.7	2.3	66	58	0.0506	105	02 ATEX 122	02 ATEX 124X	02 ATEX 123	02 ATEX 125X	4
AB30 160 MA 8	AB35 160 MA 8	AC30 160 MA 8	AC35 160 MA 8	4.00	718	9.70	85	0.70	52.20	4.50	2.3	2.6	70	62	0.0919	180	02 ATEX 122	02 ATEX 124X	02 ATEX 123	02 ATEX 125X	4
AB30 160 MB 8	AB35 160 MB 8	AC30 160 MB 8	AC35 160 MB 8	5.50	725	14.00	76	0.77	73.00	3.90	2.2	2.5	70	62	0.0919	180	02 ATEX 122	02 ATEX 124X	02 ATEX 123	02 ATEX 125X	4
AB30 160 L 8	AB35 160 L 8	AC30 160 L 8	AC35 160 L 8	7.50	720	18.00	80	0.77	99.50	4.20	2.4	2.8	70	62	0.1218	195	02 ATEX 122	02 ATEX 124X	02 ATEX 123	02 ATEX 125X	4
AB30 180 L 8	AB35 180 L 8	AC30 180 L 8	AC35 180 L 8	11.00	720	23.00	87	0.79	146.40	5.70	2.2	2.4	73	64	0.2791	245	06 ATEX 074	Pending	06 ATEX 073	Pending	4
AB30 200 LB 8	AB35 200 LB 8	AC30 200 LB 8	AC35 200 LB 8	15.00	735	35.00	89	0.70	196.00	5.30	1.6	2.1	75	65	0.4595	305	06 ATEX 074	Pending	06 ATEX 073	Pending	4
AB30 225 S 8	AB35 225 S 8	AC30 225 S 8	AC35 225 S 8	18.50	735	42.25	88	0.72	240.33	5.80	2.4	2.7	79	68	0.6337	360	06 ATEX 074	Pending	06 ATEX 073	Pending	4
AB30 225 M 8	AB35 225 M 8	AC30 225 M 8	AC35 225 M 8	22.00	730	46.00	88	0.79	288.00	5.00	2.1	2.3	79	68	0.7617	385	06 ATEX 074	Pending	06 ATEX 073	Pending	4
AB30 250 M 8	AB35 250 M 8	AC30 250 M 8	AC35 250 M 8	30.00	740	61.00	94	0.76	386.90	6.20	1.8	2.2	79	68	1.2961	550	06 ATEX 074	Pending	06 ATEX 073	Pending	4
AB30 280 S 8	AB35 280 S 8	AC30 280 S 8	AC35 280 S 8	37.00	730	71.00	90	0.86	492.30	5.50	1.9	2.5	72	60	1.5100	890	08 ATEX 012	---	00 ATEX 053	01 ATEX 003X	4
AB30 280 M 8	AB35 280 M 8	AC30 280 M 8	AC35 280 M 8	45.00	739	83.00	94	0.83	581.53	5.30	1.4	1.9	72	60	1.7900	916	08 ATEX 012	---	00 ATEX 053	01 ATEX 003X	4
AB30 315 S 8	AB35 315 S 8	AC30 315 S 8	AC35 315 S 8	55.00	742	113.50	93	0.76	712.00	8.80	2.7	2.9	75	61	1.9900	965	08 ATEX 012	---	00 ATEX 053	01 ATEX 003X	4
AB30 315 M 8	AB35 315 M 8	AC30 315 M 8	AC35 315 M 8	75.00	735	145.00	93	0.80	972.00	5.80	2.0	2.5	75	61	2.1800	991	08 ATEX 012	---	00 ATEX 053	01 ATEX 003X	4
AB30 315 LA 8	AB35 315 LA 8	AC30 315 LA 8	AC35 315 LA 8	75.00	744	136.60	94	0.84	1414.00	6.40	1.7	2.0	77	63	5.7300	1340	08 ATEX 021	---	07 ATEX 073	---	4
AB30 315 LB 8	AB35 315 LB 8	AC30 315 LB 8	AC35 315 LB 8	90.00	744	164.50	95	0.84	1164.00	6.40	1.7	2.5	77	63	6.9400	1480	08 ATEX 021	---	07 ATEX 073	---	4
AB30 315 LC 8	AB35 315 LC 8	AC30 315 LC 8	AC35 315 LC 8	110.00	743	202.00	94	0.84	1414.00	6.40	1.7	2.7	77	63	8.4500	1600	08 ATEX 021	---	07 ATEX 073	---	4

$$I_n^{\triangleright} = I_n \cdot \frac{400}{U}$$

(I<sub>n</sub><sup>▷</sup> = current at U' Volt);  
(I<sub>n</sub><sup>▷</sup> = intensité à U' Volt);  
(I<sub>n</sub><sup>▷</sup> = Strom mit U' Volt);  
(I<sub>n</sub><sup>▷</sup> = corriente de U' Voltios);  
(I<sub>n</sub><sup>▷</sup> = corrente a U' Volt);

$$J = \frac{PD^2}{4}$$

★ Versions that need special installation solutions  
*Versions qui demandent des mesures particulières pour l'installation*  
Ausführungen, die bei der Installation besondere Vorsichtsmaßnahmen erfordern  
*Versiones que requieren precauciones especiales de instalación*  
Versioni che richiedono particolari accorgimenti di installazione

◆ T3, T5 and T6 see table 1B  
T3, T5 et T6 voir tableau 1B  
T3, T5 und T6 siehe Tabelle 1B  
T3, T5 y T6 véase tabla 1B  
T3, T5 e T6 vedi tabella 1B



GB	Three-phase motors				Speeds		Rated data at		direct on line start		For general purpose (constant torque) - 1 winding Dahlander-connected					rpm	GB
F	Moteurs triphasés				Vitesses		Données nominales à		démarrage direct		Pour usage général (couple constant) - 1 enroulement couplage Dahlander					tours/min	F
D	Drehstrom Motoren				Drehzahlen		Betriebsdaten bei		Direkteinschaltung		Für allgemeinen Gebrauch (konstantes Gegenmoment) - 1 Wicklung / Schaltung Dahlander					U/min	D
E	4. Motores trifásicos				Velocidades		Datos nominales		arranque directo		Para uso general (par constante) - 1 devanado con conexión Dahlander					3000 rev/min	E
I	4.2 Motori trifase				Velocità		Dati nominali a		avviamento diretto		Per uso generale (coppia costante) - 1 avvolgimento collegamento Dahlander					1500 giri/min	I

Motor type	Rated output	Speed	Current	Efficiency	Power factor	Torque	Starting current	Starting torque	Noise level	Moment of inertia	Mass	CESI Certificates	Class T
<i>Moteur type</i>	<i>Puissance</i>	<i>Vitesse</i>	<i>Intensité</i>	<i>Rendement</i>	<i>Facteur de puissance</i>	<i>Couple</i>	<i>Intensité démarrage</i>	<i>Couple démarrage</i>	<i>Niveau de bruit</i>	<i>Moment d'inertie</i>	<i>Masse</i>	<i>CESI Certificat</i>	<i>Classe T</i>
<i>Motor Typ</i>	<i>Leistung</i>	<i>Drehzahl</i>	<i>Strom</i>	<i>Wirkungsgrad</i>	<i>Leistungs-faktor</i>	<i>Moment</i>	<i>Anlauf-strom</i>	<i>Anlauf-moment</i>	<i>Schalldruck-pegel</i>	<i>Trägheits-moment</i>	<i>Masse</i>	<i>CESI Konformitäts-Bescheinigung</i>	<i>Klasse T</i>
<i>Tipo de motor</i>	<i>Potencia proporcionada</i>	<i>Velocidad</i>	<i>Corriente</i>	<i>Rendimiento</i>	<i>Factor de potencia</i>	<i>Par</i>	<i>Corriente de arranque</i>	<i>Par de arranque</i>	<i>Nivel de ruido</i>	<i>Momento de inercia</i>	<i>Peso</i>	<i>Certificados CESI</i>	<i>Clase T</i>
<i>Tipo motore</i>	<i>Potenza resa</i>	<i>Velocità</i>	<i>Corrente</i>	<i>Rendimento</i>	<i>Fattore potenza</i>	<i>Coppia</i>	<i>Corrente avviamento</i>	<i>Coppia avviamento</i>	<i>Rumorosità</i>	<i>Momento d'inertzia</i>	<i>Massa</i>	<i>Certificato CESI</i>	<i>Classe T</i>

IIB		IIC		P <sub>n</sub> [kW]	n [1/min]	I <sub>n</sub> [A]	η [%]	cos φ	M <sub>n</sub> [Nm]	I <sub>a</sub> /I <sub>n</sub>	M <sub>a</sub> /M <sub>n</sub>	[dB(A)]		J ▼ [kgm <sup>2</sup> ]	m [kg]	IIB		IIC		◆
Ex d	Ex de	Ex d	Ex de									L <sub>w</sub>	L <sub>p</sub>			standard	★	standard	★	
AB20 63 B 24	AB25 63 B 24	AC20 63 B 24	AC25 63 B 24	0.20 0.15	2740 1310	0.52 0.59	68 49	0.83 0.74	0.7 1.1	3.5 2.2	2.6 1.5	52 44	0.0002	16	01 ATEX 102	02 ATEX 044X	01 ATEX 103	02 ATEX 045X	4	
AB20 71 A 24	AB25 71 A 24	AC20 71 A 24	AC25 71 A 24	0.30 0.20	2890 1440	1.05 1.10	56 47	0.74 0.56	1.0 1.3	3.2 2.9	1.7 1.5	56 48	0.0006	19	01 ATEX 102	02 ATEX 044X	01 ATEX 103	02 ATEX 045X	4	
AB20 71 B 24	AB25 71 B 24	AC20 71 B 24	AC25 71 B 24	0.45 0.30	2805 1420	1.26 1.20	62 59	0.83 0.63	1.5 2.0	3.8 3.6	1.8 1.6	56 48	0.0009	19	01 ATEX 102	02 ATEX 044X	01 ATEX 103	02 ATEX 045X	4	
AB20 80 A 24	AB25 80 A 24	AC20 80 A 24	AC25 80 A 24	0.60 0.45	2800 1400	1.60 1.20	68 69	0.87 0.84	2.1 3.1	4.8 4.6	1.3 2.3	59 51	0.0009	26	01 ATEX 102	02 ATEX 044X	01 ATEX 103	02 ATEX 045X	4	
AB20 80 B 24	AB25 80 B 24	AC20 80 B 24	AC25 80 B 24	0.80 0.60	2800 1400	2.10 1.70	64 72	0.85 0.71	2.7 4.1	4.4 4.1	1.8 1.7	59 51	0.0013	26	01 ATEX 102	02 ATEX 044X	01 ATEX 103	02 ATEX 045X	4	
AB20 90 S 24	AB25 90 S 24	AC20 90 S 24	AC25 90 S 24	1.25 0.90	2780 1380	2.90 2.40	65 64	0.96 0.85	4.3 6.2	5.4 4.6	2.0 1.8	62 54	0.0020	33	01 ATEX 102	02 ATEX 044X	01 ATEX 103	02 ATEX 045X	4	
AB20 90 L 24	AB25 90 L 24	AC20 90 L 24	AC25 90 L 24	1.60 1.20	2800 1400	3.60 2.90	72 78	0.90 0.77	5.5 8.2	4.3 4.3	2.2 2.1	62 54	0.0026	33	01 ATEX 102	02 ATEX 044X	01 ATEX 103	02 ATEX 045X	4	
AB20 100 LA 24	AB25 100 LA 24	AC20 100 LA 24	AC25 100 LA 24	2.35 1.85	2780 1400	5.40 4.50	70 72	0.90 0.82	8.1 12.6	6.4 5.4	2.4 2.1	63 55	0.0043	46	01 ATEX 102	02 ATEX 044X	01 ATEX 103	02 ATEX 045X	4	
AB20 100 LB 24	AB25 100 LB 24	AC20 100 LB 24	AC25 100 LB 24	3.00 2.40	2880 1420	7.30 5.70	73 79	0.77 0.77	10.0 16.1	6.6 5.1	2.6 2.4	63 55	0.0053	46	01 ATEX 102	02 ATEX 044X	01 ATEX 103	02 ATEX 045X	4	
AB20 112 M 24	AB25 112 M 24	AC20 112 M 24	AC25 112 M 24	4.00 3.30	2860 1450	8.60 6.80	84 65	0.80 0.80	13.4 21.7	7.0 6.2	2.3 2.2	68 60	0.0103	65	02 ATEX 122	02 ATEX 124X	02 ATEX 123	02 ATEX 125X	4	
AB20 132 S 24	AB25 132 S 24	AC20 132 S 24	AC25 132 S 24	5.90 4.80	2880 1430	11.50 10.00	80 82	0.93 0.85	19.6 32.1	7.2 6.4	2.2 2.1	72 64	0.0150	95	02 ATEX 122	02 ATEX 124X	02 ATEX 123	02 ATEX 125X	4	
AB20 132 MB 24	AB25 132 MB 24	AC20 132 MB 24	AC25 132 MB 24	7.50 5.50	2880 1430	14.50 13.50	88 73	0.85 0.80	24.9 36.8	8.9 7.1	2.2 2.1	75 67	0.0178	95	02 ATEX 122	02 ATEX 124X	02 ATEX 123	02 ATEX 125X	4	
AB20 132 L 24	AB25 132 L 24	AC20 132 L 24	AC25 132 L 24	8.00 6.00	2890 1440	19.00 17.00	72 63	0.85 0.80	26.5 39.3	7.5 6.3	2.3 2.2	75 67	0.0216	105	02 ATEX 122	02 ATEX 124X	02 ATEX 123	02 ATEX 125X	4	
AB20 160 M 24	AB25 160 M 24	AC20 160 M 24	AC25 160 M 24	11.00 8.80	2940 1440	22.00 22.00	80 78	0.90 0.74	35.7 58.4	7.3 6.5	2.3 2.1	77 69	0.0627	180	02 ATEX 122	02 ATEX 124X	02 ATEX 123	02 ATEX 125X	4	
AB20 160 L 24	AB25 160 L 24	AC20 160 L 24	AC25 160 L 24	15.00 12.00	2945 1450	29.50 28.50	77 81	0.95 0.75	48.6 79.0	7.5 6.6	2.4 2.3	77 69	0.0801	195	02 ATEX 122	02 ATEX 124X	02 ATEX 123	02 ATEX 125X	4	
AB20 180 M 24	AB25 180 M 24	AC20 180 M 24	AC25 180 M 24	18.50 15.00	2930 1460	36.00 29.50	82 83	0.90 0.88	60.3 98.1	6.4 5.6	2.1 2.0	79 70	0.1270	230	06 ATEX 074	Pending	06 ATEX 073	Pending	4	
AB20 180 L 24	AB25 180 L 24	AC20 180 L 24	AC25 180 L 24	22.00 18.50	2960 1465	42.60 38.00	89 90	0.84 0.78	71.2 121.1	6.6 5.8	2.2 2.1	79 70	0.1488	245	06 ATEX 074	Pending	06 ATEX 073	Pending	4	
AB20 200 LB 24	AB25 200 LB 24	AC20 200 LB 24	AC25 200 LB 24	30.00 24.00	2970 1480	54.60 44.60	90 93	0.88 0.84	97.3 156.5	7.0 6.4	2.3 2.3	82 72	0.2436	315	06 ATEX 074	Pending	06 ATEX 073	Pending	4	
AB20 225 S 24	AB25 225 S 24	AC20 225 S 24	AC25 225 S 24	33.00 30.00	2955 1475	66.00 55.00	80 91	0.90 0.87	106.6 194.2	6.8 6.2	2.2 2.1	84 73	0.3762	355	06 ATEX 074	Pending	06 ATEX 073	Pending	4	
AB20 225 M 24	AB25 225 M 24	AC20 225 M 24	AC25 225 M 24	40.00 37.00	2965 1480	77.00 69.00	82 88	0.92 0.88	128.8 238.7	6.8 6.2	2.2 2.2	84 73	0.4451	380	06 ATEX 074	Pending	06 ATEX 073	Pending	4	
AB20 250 M 24	AB25 250 M 24	AC20 250 M 24	AC25 250 M 24	50.00 42.00	2975 1480	86.50 74.00	89 93	0.94 0.89	160.3 270.8	6.9 6.4	2.1 2.3	86 75	0.4611	450	06 ATEX 074	Pending	06 ATEX 073	Pending	4	
AB20 280 S 24	AB25 280 S 24	AC20 280 S 24	AC25 280 S 24	66.00 52.00	2950 1480	123.30 102.80	91 85	0.85 0.86	200.7 238.8	9.4 8.2	2.8 2.7	82 70	0.5200	890	08 ATEX 012	---	00 ATEX 053	01 ATEX 003X	4	
AB20 280 M 24	AB25 280 M 24	AC20 280 M 24	AC25 280 M 24	79.00 60.00	2950 1480	145.90 122.90	91 84	0.86 0.84	242.8 290.4	9.2 8.0	2.8 2.6	82 70	0.6300	916	08 ATEX 012	---	00 ATEX 053	01 ATEX 003X	4	
AB20 315 S 24	AB25 315 S 24	AC20 315 S 24	AC25 315 S 24	90.00 70.00	2955 1485	166.10 133.80	89 90	0.88 0.84	323.2 334.4	9.4 8.0	2.9 2.9	85 71	0.7000	971	08 ATEX 012	---	00 ATEX 053	01 ATEX 003X	4	
AB20 315 M 24	AB25 315 M 24	AC20 315 M 24	AC25 315 M 24	95.00 75.00	2965 1485	173.30 140.10	89 91	0.89 0.85	347.9 353.7	9.5 8.1	2.9 2.8	85 71	0.7500	984	08 ATEX 012	---	00 ATEX 053	01 ATEX 003X	4	
AB20 315 LA 24	AB25 315 LA 24	AC20 315 LA 24	AC25 315 LA 24	○	○	○	○	○	○	○	○	○	○	○	08 ATEX 021	---	07 ATEX 073	---	4	
AB20 315 LB 24	AB25 315 LB 24	AC20 315 LB 24	AC25 315 LB 24	○	○	○	○	○	○	○	○	○	○	○	08 ATEX 021	---	07 ATEX 073	---	4	
AB20 315 LC 24	AB25 315 LC 24	AC20 315 LC 24	AC25 315 LC 24	○	○	○	○	○	○	○	○	○	○	○	08 ATEX 021	---	07 ATEX 073	---	4	

○ Data not indicated is supplied on request - Les données qui ne sont pas indiquées sont fournies sur demande - Die nicht angegebenen Daten werden auf Anfrage geliefert - Los datos que no se han precisado se pueden comunicar cuando se solicite - I dati non indicati sono forniti su richiesta

▶ - ▼ - ★ - ◆ - see the notes in section 4.1 - voir remarques dans la section 4.1 - siehe Anmerkung in Abschnitt 4.1 - véase notas en la sección 4.1 - vedi note di sezione 4.1

<b>GB</b>	Three-phase motors	<b>II 2G</b> <b>II 2GD</b>	<b>2</b>	Speeds	Rated data at	direct on line start	For general purpose (constant torque) - 1 winding Dahlander-connected	<b>1500</b> <b>750</b>	rpm	<b>GB</b>
<b>F</b>	Moteurs triphasés			Vitesses	Données nominales à	démarrage direct	Pour usage général (couple constant) - 1 enroulement couplage Dahlander		tours/min	<b>F</b>
<b>D</b>	Drehstrom Motoren			Drehzahlen	Betriebsdaten bei	Direkteinschaltung	Für allgemeinen Gebrauch (konstantes Gegenmoment) - 1 Wicklung / Schaltung Dahlander		U/min	<b>D</b>
<b>E</b>	Motores trifásicos			Velocidades	Datos nominales	arranque directo	Para uso general (par constante) - 1 devanado con conexión Dahlander		rev/min	<b>E</b>
<b>I</b>	Motori trifase			Velocità	Dati nominali a	avviamento diretto	Per uso generale (coppia costante) - 1 avvolgimento collegamento Dahlander		giri/min	<b>I</b>

Motor type	Rated output	Speed	Current	Efficiency	Power factor	Torque	Starting current	Starting torque	Noise level	Moment of inertia	Mass	CESI Certificates	Class T
Moteur type	Puissance	Vitesse	Intensité	Rendement	Facteur de puissance	Couple	Intensité démarrage	Couple démarrage	Niveau de bruit	Moment d'inertie	Masse	CESI Certificat	Classe T
Motor Typ	Leistung	Drehzahl	Strom	Wirkungsgrad	Leistungs-faktor	Moment	Anlauf-strom	Anlauf-moment	Schalldruck-pegel	Trägheits-moment	Masse	CESI Konformitäts-Bescheinigung	Klasse T
Tipo de motor	Potencia proporcionada	Velocidad	Corriente	Rendimiento	Factor de potencia	Par	Corriente de arranque	Par de arranque	Nivel de ruido	Momento de inercia	Peso	Certificados CESI	Clase T
Tipo motore	Potenza resa	Velocità	Corrente	Rendimento	Fattore potenza	Coppia	Corrente avviamento	Coppia avviamento	Rumorosità	Momento d'inerzia	Massa	Certificato CESI	Classe T

IIB		IIC		P <sub>n</sub> [kW]	n [1/min]	I <sub>n</sub> [A]	η [%]	cos φ	M <sub>n</sub> [Nm]	I <sub>a</sub> /I <sub>n</sub>	M <sub>a</sub> /M <sub>n</sub>	[dB(A)]		J [kgm <sup>2</sup> ]	m [kg]	IIB		IIC		◆
Ex d	Ex de	Ex d	Ex de									Lw	Lp			standard	★	standard	★	
<b>AB20 71 A 48</b>	AB25 71 A 48	<b>AC20 71 A 48</b>	AC25 71 A 48	0.17	1330	0.57	74	0.58	1.2	3.2	1.5	48	40	0.0007	19	01 ATEX 102	02 ATEX 044X	01 ATEX 103	02 ATEX 045X	4
<b>AB20 71 B 48</b>	AB25 71 B 48	<b>AC20 71 B 48</b>	AC25 71 B 48	0.09	670	0.48	48	0.57	1.3	2.4	1.4	48	40	0.0010	19	01 ATEX 102	02 ATEX 044X	01 ATEX 103	02 ATEX 045X	4
<b>AB20 80 A 48</b>	AB25 80 A 48	<b>AC20 80 A 48</b>	AC25 80 A 48	0.20	1400	0.71	68	0.80	1.4	3.4	1.6	48	40	0.0010	19	01 ATEX 102	02 ATEX 044X	01 ATEX 103	02 ATEX 045X	4
<b>AB20 80 B 48</b>	AB25 80 B 48	<b>AC20 80 B 48</b>	AC25 80 B 48	0.10	700	0.67	35	0.52	1.4	2.6	1.5	49	41	0.0022	26	01 ATEX 102	02 ATEX 044X	01 ATEX 103	02 ATEX 045X	4
<b>AB20 80 A 48</b>	AB25 80 A 48	<b>AC20 80 A 48</b>	AC25 80 A 48	0.30	1400	0.90	67	0.72	2.1	4.3	2.0	49	41	0.0022	26	01 ATEX 102	02 ATEX 044X	01 ATEX 103	02 ATEX 045X	4
<b>AB20 80 B 48</b>	AB25 80 B 48	<b>AC20 80 B 48</b>	AC25 80 B 48	0.15	710	1.05	42	0.48	2.0	2.7	1.7	49	41	0.0027	26	01 ATEX 102	02 ATEX 044X	01 ATEX 103	02 ATEX 045X	4
<b>AB20 80 B 48</b>	AB25 80 B 48	<b>AC20 80 B 48</b>	AC25 80 B 48	0.40	1400	1.10	63	0.83	2.7	3.5	1.5	49	41	0.0027	26	01 ATEX 102	02 ATEX 044X	01 ATEX 103	02 ATEX 045X	4
<b>AB20 90 S 48</b>	AB25 90 S 48	<b>AC20 90 S 48</b>	AC25 90 S 48	0.20	710	1.10	47	0.56	2.7	2.5	1.3	53	45	0.0034	33	01 ATEX 102	02 ATEX 044X	01 ATEX 103	02 ATEX 045X	4
<b>AB20 90 S 48</b>	AB25 90 S 48	<b>AC20 90 S 48</b>	AC25 90 S 48	0.60	1390	1.40	75	0.83	4.1	3.6	1.6	53	45	0.0034	33	01 ATEX 102	02 ATEX 044X	01 ATEX 103	02 ATEX 045X	4
<b>AB20 90 L 48</b>	AB25 90 L 48	<b>AC20 90 L 48</b>	AC25 90 L 48	0.30	700	1.30	62	0.54	4.1	2.7	1.5	53	45	0.0049	33	01 ATEX 102	02 ATEX 044X	01 ATEX 103	02 ATEX 045X	4
<b>AB20 90 L 48</b>	AB25 90 L 48	<b>AC20 90 L 48</b>	AC25 90 L 48	0.90	1370	2.00	74	0.90	6.4	4.0	1.8	53	45	0.0049	33	01 ATEX 102	02 ATEX 044X	01 ATEX 103	02 ATEX 045X	4
<b>AB20 100 LA 48</b>	AB25 100 LA 48	<b>AC20 100 LA 48</b>	AC25 100 LA 48	0.45	710	1.80	65	0.60	6.1	3.1	1.6	60	52	0.0088	46	01 ATEX 102	02 ATEX 044X	01 ATEX 103	02 ATEX 045X	4
<b>AB20 100 LA 48</b>	AB25 100 LA 48	<b>AC20 100 LA 48</b>	AC25 100 LA 48	1.25	1400	3.20	81	0.70	8.5	3.8	2.0	60	52	0.0088	46	01 ATEX 102	02 ATEX 044X	01 ATEX 103	02 ATEX 045X	4
<b>AB20 100 LB 48</b>	AB25 100 LB 48	<b>AC20 100 LB 48</b>	AC25 100 LB 48	0.60	700	3.00	61	0.47	8.2	3.0	1.8	60	52	0.0088	46	01 ATEX 102	02 ATEX 044X	01 ATEX 103	02 ATEX 045X	4
<b>AB20 100 LB 48</b>	AB25 100 LB 48	<b>AC20 100 LB 48</b>	AC25 100 LB 48	1.60	1445	3.60	73	0.88	10.6	4.8	1.9	60	52	0.0088	46	01 ATEX 102	02 ATEX 044X	01 ATEX 103	02 ATEX 045X	4
<b>AB20 112 M 48</b>	AB25 112 M 48	<b>AC20 112 M 48</b>	AC25 112 M 48	0.80	700	4.00	59	0.49	10.9	3.7	1.6	62	54	0.0172	65	02 ATEX 122	02 ATEX 124X	02 ATEX 123	02 ATEX 125X	4
<b>AB20 112 M 48</b>	AB25 112 M 48	<b>AC20 112 M 48</b>	AC25 112 M 48	2.55	1420	5.40	78	0.90	17.2	5.1	2.0	62	54	0.0172	65	02 ATEX 122	02 ATEX 124X	02 ATEX 123	02 ATEX 125X	4
<b>AB20 132 S 48</b>	AB25 132 S 48	<b>AC20 132 S 48</b>	AC25 132 S 48	1.25	710	4.90	66	0.61	16.8	3.9	2.5	66	58	0.0323	95	02 ATEX 122	02 ATEX 124X	02 ATEX 123	02 ATEX 125X	4
<b>AB20 132 S 48</b>	AB25 132 S 48	<b>AC20 132 S 48</b>	AC25 132 S 48	3.30	1430	7.20	77	0.86	22.5	5.0	1.7	66	58	0.0323	95	02 ATEX 122	02 ATEX 124X	02 ATEX 123	02 ATEX 125X	4
<b>AB20 132 MB 48</b>	AB25 132 MB 48	<b>AC20 132 MB 48</b>	AC25 132 MB 48	1.85	720	8.30	58	0.56	24.5	3.6	1.6	66	58	0.0506	95	02 ATEX 122	02 ATEX 124X	02 ATEX 123	02 ATEX 125X	4
<b>AB20 132 MB 48</b>	AB25 132 MB 48	<b>AC20 132 MB 48</b>	AC25 132 MB 48	4.80	1410	10.50	77	0.86	32.5	5.3	1.8	66	58	0.0506	95	02 ATEX 122	02 ATEX 124X	02 ATEX 123	02 ATEX 125X	4
<b>AB20 132 L 48</b>	AB25 132 L 48	<b>AC20 132 L 48</b>	AC25 132 L 48	2.40	700	8.10	68	0.63	32.0	4.4	1.7	66	58	0.0506	105	02 ATEX 122	02 ATEX 124X	02 ATEX 123	02 ATEX 125X	4
<b>AB20 132 L 48</b>	AB25 132 L 48	<b>AC20 132 L 48</b>	AC25 132 L 48	5.50	1450	11.00	87	0.83	36.2	5.6	1.8	66	58	0.0506	105	02 ATEX 122	02 ATEX 124X	02 ATEX 123	02 ATEX 125X	4
<b>AB20 160 M 48</b>	AB25 160 M 48	<b>AC20 160 M 48</b>	AC25 160 M 48	3.00	720	13.50	72	0.45	40.0	4.6	1.8	70	62	0.0919	180	02 ATEX 122	02 ATEX 124X	02 ATEX 123	02 ATEX 125X	4
<b>AB20 160 M 48</b>	AB25 160 M 48	<b>AC20 160 M 48</b>	AC25 160 M 48	7.50	1450	16.00	82	0.82	49.4	5.8	1.9	70	62	0.0919	180	02 ATEX 122	02 ATEX 124X	02 ATEX 123	02 ATEX 125X	4
<b>AB20 160 L 48</b>	AB25 160 L 48	<b>AC20 160 L 48</b>	AC25 160 L 48	4.80	730	15.00	83	0.56	62.8	4.8	1.7	70	62	0.1218	195	02 ATEX 122	02 ATEX 124X	02 ATEX 123	02 ATEX 125X	4
<b>AB20 160 L 48</b>	AB25 160 L 48	<b>AC20 160 L 48</b>	AC25 160 L 48	10.00	1440	21.00	76	0.91	66.3	6.9	1.8	70	62	0.1218	195	02 ATEX 122	02 ATEX 124X	02 ATEX 123	02 ATEX 125X	4
<b>AB20 180 M 48</b>	AB25 180 M 48	<b>AC20 180 M 48</b>	AC25 180 M 48	6.60	710	22.00	73	0.59	88.8	5.7	1.8	73	64	0.2067	230	06 ATEX 074	Pending	06 ATEX 073	Pending	4
<b>AB20 180 M 48</b>	AB25 180 M 48	<b>AC20 180 M 48</b>	AC25 180 M 48	13.00	1474	26.50	81	0.87	84.1	6.6	2.0	73	64	0.2067	230	06 ATEX 074	Pending	06 ATEX 073	Pending	4
<b>AB20 180 L 48</b>	AB25 180 L 48	<b>AC20 180 L 48</b>	AC25 180 L 48	8.10	735	22.50	85	0.61	105.2	5.3	2.0	73	64	0.2067	245	06 ATEX 074	Pending	06 ATEX 073	Pending	4
<b>AB20 180 L 48</b>	AB25 180 L 48	<b>AC20 180 L 48</b>	AC25 180 L 48	16.00	1470	31.00	85	0.88	103.9	6.5	1.9	73	64	0.2067	245	06 ATEX 074	Pending	06 ATEX 073	Pending	4
<b>AB20 200 LB 48</b>	AB25 200 LB 48	<b>AC20 200 LB 48</b>	AC25 200 LB 48	9.90	730	27.00	87	0.61	129.5	5.3	1.9	75	65	0.2436	315	06 ATEX 074	Pending	06 ATEX 073	Pending	4
<b>AB20 200 LB 48</b>	AB25 200 LB 48	<b>AC20 200 LB 48</b>	AC25 200 LB 48	20.00	1480	37.30	91	0.85	129.0	7.4	2.8	75	65	0.2436	315	06 ATEX 074	Pending	06 ATEX 073	Pending	4
<b>AB20 225 S 48</b>	AB25 225 S 48	<b>AC20 225 S 48</b>	AC25 225 S 48	13.00	730	39.00	86	0.56	170.2	4.6	2.9	79	68	0.3762	355	06 ATEX 074	Pending	06 ATEX 073	Pending	4
<b>AB20 225 S 48</b>	AB25 225 S 48	<b>AC20 225 S 48</b>	AC25 225 S 48	25.00	1460	47.50	82	0.93	163.5	6.5	2.1	79	68	0.3762	355	06 ATEX 074	Pending	06 ATEX 073	Pending	4
<b>AB20 225 M 48</b>	AB25 225 M 48	<b>AC20 225 M 48</b>	AC25 225 M 48	17.00	720	44.50	79	0.70	225.5	5.2	1.9	79	68	0.4451	380	06 ATEX 074	Pending	06 ATEX 073	Pending	4
<b>AB20 225 M 48</b>	AB25 225 M 48	<b>AC20 225 M 48</b>	AC25 225 M 48	30.00	1485	57.30	90	0.84	193.6	6.6	2.2	79	68	0.4451	380	06 ATEX 074	Pending	06 ATEX 073	Pending	4
<b>AB20 250 M 48</b>	AB25 250 M 48	<b>AC20 250 M 48</b>	AC25 250 M 48	20.00	735	61.00	88	0.54	261.0	5.5	2.1	79	68	0.4611	450	06 ATEX 074	Pending	06 ATEX 073	Pending	4
<b>AB20 250 M 48</b>	AB25 250 M 48	<b>AC20 250 M 48</b>	AC25 250 M 48	40.00	1480	73.00	91	0.88	258.4	6.4	2.2	79	68	0.4611	450	06 ATEX 074	Pending	06 ATEX 073	Pending	4
<b>AB20 280 S 48</b>	AB25 280 S 48	<b>AC20 280 S 48</b>	AC25 280 S 48	26.00	735	67.50	91	0.62	336.8	5.5	2.0	72	60	0.9500	890	08 ATEX 012	---	00 ATEX 053	01 ATEX 003X	4
<b>AB20 280 S 48</b>	AB25 280 S 48	<b>AC20 280 S 48</b>	AC25 280 S 48	59.00	1485	110.00	91	0.86	380.1	5.4	1.9	72	60	0.9500	890	08 ATEX 012	---	00 ATEX 053	01 ATEX 003X	4
<b>AB20 280 M 48</b>	AB25 280 M 48	<b>AC20 280 M 48</b>	AC25 280 M 48	34.00	740	101.00	90	0.55	448.5	3.8	1.5	72	60	1.1200	916	08 ATEX 012	---	00 ATEX 053	01 ATEX 003X	4
<b>AB20 280 M 48</b>	AB25 2																			

<b>GB</b>	Three-phase motors	<b>II 2G</b>	<b>II 2GD</b>	<b>2</b>	Speeds	Rated data at	direct on line start	For general purpose (constant torque) - 2 separate windings		<b>1500</b>	<b>1000</b>	rpm	<b>GB</b>
<b>F</b>	Moteurs triphasés				Vitesses	Données nominales à	démarrage direct	Pour usage général (couple constant) - 2 enroulements séparés				tours/min	<b>F</b>
<b>D</b>	Drehstrom Motoren				Drehzahlen	Betriebsdaten bei	Direkteinschaltung	Für allgemeinen Gebrauch (konstantes Gegenmoment) - 2 getrennte Wicklungen				U/min	<b>D</b>
<b>E</b>	Motores trifásicos				Velocidades	Datos nominales	arranque directo	Para uso general (par constante) - 2 devanados separados				rev/min	<b>E</b>
<b>I</b>	Motori trifase				Velocità	Dati nominali a	avviamento diretto	Per uso generale (coppia costante) - 2 avvolgimenti separati				giri/min	<b>I</b>

Motor type	Rated output	Speed	Current	Efficiency	Power factor	Torque	Starting current	Starting torque	Noise level	Moment of inertia	Mass	CESI Certificates	Class T
Moteur type	Puissance	Vitesse	Intensité	Rendement	Facteur de puissance	Couple	Intensité démarrage	Couple démarrage	Niveau de bruit	Moment d'inertie	Masse	CESI Certificat	Classe T
Motor Typ	Leistung	Drehzahl	Strom	Wirkungsgrad	Leistungs-faktor	Moment	Anlauf-strom	Anlauf-moment	Schalldruck-pegel	Trägheits-moment	Masse	CESI Konformitäts-Bescheinigung	Klasse T
Tipo de motor	Potencia proporcionada	Velocidad	Corriente	Rendimiento	Factor de potencia	Par	Corriente de arranque	Par de arranque	Nivel de ruido	Momento de inercia	Peso	Certificados CESI	Clase T
Tipo motore	Potenza resa	Velocità	Corrente	Rendimento	Fattore potenza	Coppia	Corrente avviamento	Coppia avviamento	Rumorosità	Momento d'inerzia	Massa	Certificato CESI	Classe T

IIB		IIC		P <sub>n</sub> [kW]	n [1/min]	I <sub>n</sub> [A]	η [%]	cos φ	M <sub>n</sub> [Nm]	I <sub>a</sub> /I <sub>n</sub>	M <sub>a</sub> /M <sub>n</sub>	[dB(A)]		J ▼ [kgm <sup>2</sup> ]	m [kg]	IIB		IIC		◆
Ex d	Ex de	Ex d	Ex de									Lw	Lp			standard	★	standard	★	
AB20 71 B 46	AB25 71 B 46	AC20 71 B 46	AC25 71 B 46	0.20 0.10	1420 900	0.76 0.57	60 50	0.63 0.51	1.3 1.1	3.4 2.4	1.4 1.4	50	42	0.0010	19	01 ATEX 102	02 ATEX 044X	01 ATEX 103	02 ATEX 045X	4
AB20 80 A 46	AB25 80 A 46	AC20 80 A 46	AC25 80 A 46	0.40 0.20	1360 900	1.00 0.86	80 56	0.72 0.60	2.8 2.1	3.5 2.5	1.5 1.4	53	45	0.0027	26	01 ATEX 102	02 ATEX 044X	01 ATEX 103	02 ATEX 045X	4
AB20 80 B 46	AB25 80 B 46	AC20 80 B 46	AC25 80 B 46	0.50 0.30	1380 910	1.40 0.95	70 68	0.73 0.67	3.4 3.2	3.7 3.1	1.5 1.5	53	45	0.0027	26	01 ATEX 102	02 ATEX 044X	01 ATEX 103	02 ATEX 045X	4
AB20 90 S 46	AB25 90 S 46	AC20 90 S 46	AC25 90 S 46	0.65 0.45	1475 950	2.55 1.35	78 74	0.50 0.65	4.4 4.5	4.0 3.2	1.6 1.4	54	46	0.0034	33	01 ATEX 102	02 ATEX 044X	01 ATEX 103	02 ATEX 045X	4
AB20 90 L 46	AB25 90 L 46	AC20 90 L 46	AC25 90 L 46	0.95 0.60	1455 920	2.70 1.60	80 71	0.65 0.78	6.4 6.3	5.6 3.7	1.6 1.5	54	46	0.0049	33	01 ATEX 102	02 ATEX 044X	01 ATEX 103	02 ATEX 045X	4
AB20 100 LA 46	AB25 100 LA 46	AC20 100 LA 46	AC25 100 LA 46	1.40 0.90	1400 930	3.80 2.90	70 64	0.76 0.70	9.5 9.2	5.8 4.2	1.8 1.6	63	55	0.0088	46	01 ATEX 102	02 ATEX 044X	01 ATEX 103	02 ATEX 045X	4
AB20 100 LB 46	AB25 100 LB 46	AC20 100 LB 46	AC25 100 LB 46	1.85 1.10	1415 900	4.20 3.05	77 71	0.84 0.73	12.7 11.5	4.5 3.0	1.8 1.6	63	55	0.0088	46	01 ATEX 102	02 ATEX 044X	01 ATEX 103	02 ATEX 045X	4
AB20 112 M 46	AB25 112 M 46	AC20 112 M 46	AC25 112 M 46	2.40 1.60	1420 920	5.20 4.20	79 71	0.84 0.78	16.1 16.6	6.5 4.4	1.8 1.6	65	57	0.0172	65	02 ATEX 122	02 ATEX 124X	02 ATEX 123	02 ATEX 125X	4
AB20 132 S 46	AB25 132 S 46	AC20 132 S 46	AC25 132 S 46	3.00 2.00	1475 960	8.30 5.50	83 75	0.65 0.71	20.0 19.7	6.0 4.0	2.0 1.5	68	60	0.0323	95	02 ATEX 122	02 ATEX 124X	02 ATEX 123	02 ATEX 125X	4
AB20 132 MA 46	AB25 132 MA 46	AC20 132 MA 46	AC25 132 MA 46	4.00 2.60	1460 960	9.40 8.40	79 72	0.78 0.62	26.2 25.9	6.2 4.6	2.0 1.8	68	60	0.0395	95	02 ATEX 122	02 ATEX 124X	02 ATEX 123	02 ATEX 125X	4
AB20 132 MB 46	AB25 132 MB 46	AC20 132 MB 46	AC25 132 MB 46	4.40 3.00	1450 950	10.50 8.90	76 79	0.80 0.62	29.0 30.2	6.4 4.5	2.0 1.8	68	60	0.0506	105	02 ATEX 122	02 ATEX 124X	02 ATEX 123	02 ATEX 125X	4
AB20 132 L 46	AB25 132 L 46	AC20 132 L 46	AC25 132 L 46	5.15 3.30	1470 965	12.00 9.50	83 79	0.75 0.64	33.5 32.7	6.9 4.8	1.9 1.7	68	60	0.0506	105	02 ATEX 122	02 ATEX 124X	02 ATEX 123	02 ATEX 125X	4
AB20 160 M 46	AB25 160 M 46	AC20 160 M 46	AC25 160 M 46	6.60 4.40	1460 960	14.50 10.50	79 87	0.84 0.70	43.2 43.8	6.8 4.5	2.0 1.9	72	64	0.0919	180	02 ATEX 122	02 ATEX 124X	02 ATEX 123	02 ATEX 125X	4
AB20 160 L 46	AB25 160 L 46	AC20 160 L 46	AC25 160 L 46	8.80 5.90	1460 970	18.50 13.50	78 88	0.88 0.72	57.6 58.1	6.9 5.0	2.0 1.9	72	64	0.1218	195	02 ATEX 122	02 ATEX 124X	02 ATEX 123	02 ATEX 125X	4
AB20 180 M 46	AB25 180 M 46	AC20 180 M 46	AC25 180 M 46	11.00 7.50	1470 980	21.50 18.50	88 84	0.84 0.70	71.5 73.1	6.6 5.2	2.0 1.9	76	67	0.2067	230	06 ATEX 074	Pending	06 ATEX 073	Pending	4
AB20 180 L 46	AB25 180 L 46	AC20 180 L 46	AC25 180 L 46	13.00 8.80	1475 980	25.00 20.50	88 86	0.85 0.72	84.2 85.7	6.5 5.0	2.0 1.8	76	67	0.2067	245	06 ATEX 074	Pending	06 ATEX 073	Pending	4
AB20 200 LA 46	AB25 200 LA 46	AC20 200 LA 46	AC25 200 LA 46	16.00 11.00	1480 985	33.50 24.50	82 80	0.84 0.81	103.2 106.6	6.7 5.4	2.1 1.9	79	69	0.2986	295	06 ATEX 074	Pending	06 ATEX 073	Pending	4
AB20 200 LB 46	AB25 200 LB 46	AC20 200 LB 46	AC25 200 LB 46	18.50 13.00	1485 985	40.10 28.70	88 90	0.76 0.73	119.0 126.0	9.8 8.9	2.2 3.2	79	69	0.3503	315	06 ATEX 074	Pending	06 ATEX 073	Pending	4
AB20 225 S 46	AB25 225 S 46	AC20 225 S 46	AC25 225 S 46	22.00 15.00	1485 995	42.50 33.50	89 88	0.84 0.74	141.8 144.4	6.6 5.6	2.2 2.0	81	70	0.6965	355	06 ATEX 074	Pending	06 ATEX 073	Pending	4
AB20 225 M 46	AB25 225 M 46	AC20 225 M 46	AC25 225 M 46	26.00 16.50	1480 990	48.40 33.90	91 90	0.85 0.74	167.7 159.2	6.7 5.4	2.1 1.8	81	70	0.6965	380	06 ATEX 074	Pending	06 ATEX 073	Pending	4
AB20 250 M 46	AB25 250 M 46	AC20 250 M 46	AC25 250 M 46	30.00 20.00	1480 990	55.90 41.30	90 90	0.87 0.78	195.2 193.5	5.0 4.9	1.2 1.4	81	70	0.7216	450	06 ATEX 074	Pending	06 ATEX 073	Pending	4
AB20 280 S 46	AB25 280 S 46	AC20 280 S 46	AC25 280 S 46	56.00 34.00	1480 985	109.80 78.30	91 86	0.81 0.73	361.4 329.6	8.1 6.4	2.9 2.8	77	65	0.9500	890	08 ATEX 012	---	00 ATEX 053	01 ATEX 003X	4
AB20 280 M 46	AB25 280 M 46	AC20 280 M 46	AC25 280 M 46	65.00 40.00	1480 985	124.50 89.60	92 86	0.82 0.75	419.4 387.8	8.2 6.2	2.8 2.9	77	65	1.1200	916	08 ATEX 012	---	00 ATEX 053	01 ATEX 003X	4
AB20 315 S 46	AB25 315 S 46	AC20 315 S 46	AC25 315 S 46	75.00 46.00	1485 990	147.00 103.30	91 87	0.81 0.74	482.3 443.7	8.3 6.4	2.9 3.0	79	65	1.2700	971	08 ATEX 012	---	00 ATEX 053	01 ATEX 003X	4
AB20 315 M 46	AB25 315 M 46	AC20 315 M 46	AC25 315 M 46	80.00 50.00	1488 990	145.00 104.40	96 93	0.84 0.74	518.0 482.6	8.2 6.4	2.8 3.0	79	65	1.3300	984	08 ATEX 012	---	00 ATEX 053	01 ATEX 003X	4
AB20 315 LA 46	AB25 315 LA 46	AC20 315 LA 46	AC25 315 LA 46	○	○	○	○	○	○	○	○	○	○	○	○	08 ATEX 021	---	07 ATEX 073	---	4
AB20 315 LB 46	AB25 315 LB 46	AC20 315 LB 46	AC25 315 LB 46	○	○	○	○	○	○	○	○	○	○	○	○	08 ATEX 021	---	07 ATEX 073	---	4
AB20 315 LC 46	AB25 315 LC 46	AC20 315 LC 46	AC25 315 LC 46	○	○	○	○	○	○	○	○	○	○	○	○	08 ATEX 021	---	07 ATEX 073	---	4

○ Data not indicated is supplied on request - Les données qui ne sont pas indiquées sont fournies sur demande - Die nicht angegebenen Daten werden auf Anfrage geliefert - Los datos que no se han precisado se pueden comunicar cuando se solicite - I dati non indicati sono forniti su richiesta

◆ - ▼ - ★ - ◆ - see the notes in section 4.1 - voir remarques dans la section 4.1 - siehe Anmerkung in Abschnitt 4.1 - véase notas en la sección 4.1 - vedi note di sezione 4.1



GB	Three-phase motors	Speeds	Rated data at	direct on line start	For general purpose (constant torque) - 2 separate windings	rpm	GB
F	Moteurs triphasés	Vitesses	Données nominales à	démarrage direct	Pour usage général (couple constant) - 2 enroulements séparés	tours/min	F
D	Drehstrom Motoren	Drehzahlen	Betriebsdaten bei	Direkteinschaltung	Für allgemeinen Gebrauch (konstantes Gegenmoment) - 2 getrennte Wicklungen	U/min	D
E	Motores trifásicos	Velocidades	Datos nominales	arranque directo	Para uso general (par constante) - 2 devanados separados	rev/min	E
I	4.2 Motori trifase	Velocità	Dati nominali a	avviamento diretto	Per uso generale (coppia costante) - 2 avvolgimenti separati	giri/min	I

**II 2G**  
**II 2GD**

**2**

**400 V**  
**50 Hz**

**1000**  
**750**

Motor type	Rated output	Speed	Current	Efficiency	Power factor	Torque	Starting current	Starting torque	Noise level	Moment of inertia	Mass	CESI Certificates	Class T
Moteur type	Puissance	Vitesse	Intensité	Rendement	Facteur de puissance	Couple	Intensité démarrage	Couple démarrage	Niveau de bruit	Moment d'inertie	Masse	CESI Certificat	Classe T
Motor Typ	Leistung	Drehzahl	Strom	Wirkungsgrad	Leistungs-faktor	Moment	Anlauf-strom	Anlauf-moment	Schalldruck-pegel	Trägheits-moment	Masse	CESI Konformitäts-Bescheinigung	Klasse T
Tipo de motor	Potencia proporcionada	Velocidad	Corriente	Rendimiento	Factor de potencia	Par	Corriente de arranque	Par de arranque	Nivel de ruido	Momento de inercia	Peso	Certificados CESI	Clase T
Tipo motore	Potenza resa	Velocità	Corrente	Rendimento	Fattore potenza	Coppia	Corrente avviamento	Coppia avviamento	Rumorosità	Momento d'inertzia	Massa	Certificato CESI	Classe T

IIB		IIC		P <sub>n</sub> [kW]	n [1/min]	I <sub>n</sub> [A]	η [%]	cos φ	M <sub>n</sub> [Nm]	I <sub>a</sub> /I <sub>n</sub>	M <sub>a</sub> /M <sub>n</sub>	[dB(A)]		J ▼ [kgm <sup>2</sup> ]	m [kg]	IIB		IIC		◆
Ex d	Ex de	Ex d	Ex de									L <sub>w</sub>	L <sub>p</sub>			standard	★	standard	★	
AB20 71 B 68	AB25 71 B 68	AC20 71 B 68	AC25 71 B 68	0.12	960	0.73	45	0.55	1.2	3.0	2.4	48	40	0.0010	19	01 ATEX 102	02 ATEX 044X	01 ATEX 103	02 ATEX 045X	4
				0.08	670	0.48	32	0.77	1.2	1.4	1.0									
AB20 80 A 68	AB25 80 A 68	AC20 80 A 68	AC25 80 A 68	0.15	930	0.67	46	0.70	1.5	2.7	1.5	49	41	0.0027	26	01 ATEX 102	02 ATEX 044X	01 ATEX 103	02 ATEX 045X	4
				0.13	690	0.62	51	0.59	1.8	2.0	1.4									
AB20 80 B 68	AB25 80 B 68	AC20 80 B 68	AC25 80 B 68	0.25	920	1.00	51	0.71	2.6	2.8	1.6	49	41	0.0027	26	01 ATEX 102	02 ATEX 044X	01 ATEX 103	02 ATEX 045X	4
				0.15	680	0.81	46	0.58	2.1	2.1	1.3									
AB20 90 S 68	AB25 90 S 68	AC20 90 S 68	AC25 90 S 68	0.35	910	1.30	53	0.74	3.7	3.2	1.4	53	45	0.0034	33	01 ATEX 102	02 ATEX 044X	01 ATEX 103	02 ATEX 045X	4
				0.25	640	1.00	59	0.61	3.7	2.2	1.4									
AB20 90 L 68	AB25 90 L 68	AC20 90 L 68	AC25 90 L 68	0.60	930	2.00	58	0.75	6.2	3.9	1.5	53	45	0.0049	33	01 ATEX 102	02 ATEX 044X	01 ATEX 103	02 ATEX 045X	4
				0.30	690	1.30	57	0.59	4.2	3.0	1.6									
AB20 100 LA 68	AB25 100 LA 68	AC20 100 LA 68	AC25 100 LA 68	0.80	920	2.30	66	0.76	8.3	3.9	1.5	60	52	0.0088	46	01 ATEX 102	02 ATEX 044X	01 ATEX 103	02 ATEX 045X	4
				0.55	700	1.90	67	0.62	7.5	3.5	1.5									
AB20 100 LB 68	AB25 100 LB 68	AC20 100 LB 68	AC25 100 LB 68	1.00	920	3.30	54	0.82	10.4	3.0	1.1	60	52	0.0088	46	01 ATEX 102	02 ATEX 044X	01 ATEX 103	02 ATEX 045X	4
				0.65	680	2.55	50	0.74	9.1	2.5	1.6									
AB20 112 M 68	AB25 112 M 68	AC20 112 M 68	AC25 112 M 68	1.50	960	4.10	74	0.71	14.9	4.2	1.7	62	54	0.0172	65	02 ATEX 122	02 ATEX 124X	02 ATEX 123	02 ATEX 125X	4
				1.00	710	3.20	65	0.69	13.4	3.8	1.6									
AB20 132 S 68	AB25 132 S 68	AC20 132 S 68	AC25 132 S 68	1.85	960	5.20	73	0.70	18.4	4.1	1.6	66	58	0.0323	95	02 ATEX 122	02 ATEX 124X	02 ATEX 123	02 ATEX 125X	4
				1.30	715	4.20	68	0.66	17.4	4.0	1.7									
AB20 132 MA 68	AB25 132 MA 68	AC20 132 MA 68	AC25 132 MA 68	2.55	965	6.80	75	0.72	25.2	4.2	1.8	66	58	0.0395	95	02 ATEX 122	02 ATEX 124X	02 ATEX 123	02 ATEX 125X	4
				1.85	720	5.80	68	0.68	24.5	4.1	1.8									
AB20 132 MB 68	AB25 132 MB 68	AC20 132 MB 68	AC25 132 MB 68	3.00	970	7.40	79	0.74	29.5	5.4	1.9	66	58	0.0506	105	02 ATEX 122	02 ATEX 124X	02 ATEX 123	02 ATEX 125X	4
				2.00	730	6.00	73	0.66	26.2	4.0	1.8									
AB20 160 M 68	AB25 160 M 68	AC20 160 M 68	AC25 160 M 68	4.00	970	9.50	82	0.74	39.4	4.2	1.9	70	62	0.0919	180	02 ATEX 122	02 ATEX 124X	02 ATEX 123	02 ATEX 125X	4
				2.80	720	7.60	77	0.69	37.1	4.1	1.9									
AB20 160 L 68	AB25 160 L 68	AC20 160 L 68	AC25 160 L 68	5.50	985	14.60	86	0.64	53.5	4.3	1.8	70	62	0.1218	195	02 ATEX 122	02 ATEX 124X	02 ATEX 123	02 ATEX 125X	4
				4.00	732	11.60	81	0.63	52.9	4.2	1.9									
AB20 180 M 68	AB25 180 M 68	AC20 180 M 68	AC25 180 M 68	6.50	970	15.00	83	0.75	64.0	4.1	1.7	73	64	0.2067	230	06 ATEX 074	Pending	06 ATEX 073	Pending	4
				5.00	720	12.50	77	0.75	66.3	4.3	1.8									
AB20 180 L 68	AB25 180 L 68	AC20 180 L 68	AC25 180 L 68	8.00	965	17.50	85	0.78	79.2	4.4	1.8	73	64	0.2067	245	06 ATEX 074	Pending	06 ATEX 073	Pending	4
				6.00	715	15.00	78	0.74	80.1	4.2	1.9									
AB20 200 LA 68	AB25 200 LA 68	AC20 200 LA 68	AC25 200 LA 68	9.90	970	21.00	85	0.80	97.5	4.6	1.7	75	65	0.2986	295	06 ATEX 074	Pending	06 ATEX 073	Pending	4
				7.50	710	18.00	80	0.75	100.9	4.3	1.7									
AB20 200 LB 68	AB25 200 LB 68	AC20 200 LB 68	AC25 200 LB 68	12.00	990	33.40	88	0.59	115.8	4.7	1.9	75	65	0.3503	315	06 ATEX 074	Pending	06 ATEX 073	Pending	4
				8.80	736	22.20	87	0.66	114.3	4.4	1.7									
AB20 225 S 68	AB25 225 S 68	AC20 225 S 68	AC25 225 S 68	15.00	970	32.50	82	0.81	147.7	4.8	1.8	79	68	0.6965	355	06 ATEX 074	Pending	06 ATEX 073	Pending	4
				11.00	720	24.50	83	0.78	145.9	4.7	1.8									
AB20 225 M 68	AB25 225 M 68	AC20 225 M 68	AC25 225 M 68	17.00	975	37.00	81	0.82	166.5	4.9	1.8	79	68	0.6965	380	06 ATEX 074	Pending	06 ATEX 073	Pending	4
				13.00	725	30.50	80	0.77	171.2	4.6	1.9									
AB20 250 M 68	AB25 250 M 68	AC20 250 M 68	AC25 250 M 68	22.00	980	48.50	82	0.80	214.4	4.7	1.9	79	68	0.7216	450	06 ATEX 074	Pending	06 ATEX 073	Pending	4
				16.00	730	37.00	82	0.76	209.3	4.5	1.8									
AB20 280 S 68	AB25 280 S 68	AC20 280 S 68	AC25 280 S 68	37.00	990	80.30	90	0.74	356.9	7.3	3.1	72	60	1.1400	873	08 ATEX 012	---	00 ATEX 053	01 ATEX 003X	4
				25.00	740	57.00	88	0.72	322.6	5.3	2.7									
AB20 280 M 68	AB25 280 M 68	AC20 280 M 68	AC25 280 M 68	44.00	995	97.00	91	0.72	422.3	7.5	3.0	72	60	1.3600	909	08 ATEX 012	---	00 ATEX 053	01 ATEX 003X	4
				30.00	740	70.40	88	0.70	387.2	5.2	2.7									
AB20 315 S 68	AB25 315 S 68	AC20 315 S 68	AC25 315 S 68	52.00	990	112.80	90	0.74	501.6	7.9	3.4	75	61	1.6300	965	08 ATEX 012	---	00 ATEX 053	01 ATEX 003X	4
				36.00	745	81.20	89	0.72	461.5	5.4	2.9									
AB20 315 M 68	AB25 315 M 68	AC20 315 M 68	AC25 315 M 68	60.00	995	132.30	91	0.72	575.9	7.8	3.3	75	61	1.8300	997	08 ATEX 012	---	00 ATEX 053	01 ATEX 003X	4
				40.00	743	91.80	90	0.70	514.1	5.3	2.9									
AB20 315 LA 68	AB25 315 LA 68	AC20 315 LA 68	AC25 315 LA 68	○	○	○	○	○	○	○	○	○	○	○	○	08 ATEX 021	---	07 ATEX 073	---	4
AB20 315 LB 68	AB25 315 LB 68	AC20 315 LB 68	AC25 315 LB 68	○	○	○	○	○	○	○	○	○	○	○	○	08 ATEX 021	---	07 ATEX 073	---	4
AB20 315 LC 68	AB25 315 LC 68	AC20 315 LC 68	AC25 315 LC 68	○	○	○	○	○	○	○	○	○	○	○	○	08 ATEX 021	---	07 ATEX 073	---	4

○ Data not indicated is supplied on request - Les données qui ne sont pas indiquées sont fournies sur demande - Die nicht angegebenen Daten werden auf Anfrage geliefert - Los datos que no se han precisado se pueden comunicar cuando se solicite - I dati non indicati sono forniti su richiesta

◆ - ▼ - ★ - ◆ - see the notes in section 4.1 - voir remarques dans la section 4.1 - siehe Anmerkung in Abschnitt 4.1 - véase notas en la sección 4.1 - vedi note di sezione 4.1

<b>GB</b>	Three-phase motors	<b>II 2G</b> <b>II 2GD</b>	<b>2</b>	Speeds	Rated data at	direct on line start	For centrifugal machines (quadratic torque) - 1 winding Dahlander-connected	<b>3000</b> <b>1500</b>	rpm	<b>GB</b>
<b>F</b>	Moteurs triphasés			Vitesses	Données nominales à	démarrage direct	Pour machines centrifuges (couple quadratique) - 1 enroulement couplage Dahlander		tours/min	<b>F</b>
<b>D</b>	Drehstrom Motoren			Drehzahlen	Betriebsdaten bei	Direkteinschaltung	Für Zentrifugalmaschinen (quadratisches Gegenmoment) - 1 Wicklung / Schaltung Dahlander		U/min	<b>D</b>
<b>E</b>	Motores trifásicos			Velocidades	Datos nominales	arranque directo	Para máquinas centrifugas (par cuadrático) - 1 devanado con conexión Dahlander		rev/min	<b>E</b>
<b>I</b>	Motori trifase			Velocità	Dati nominali a	avviamento diretto	Per macchine centrifughe (coppia quadratica) - 1 avvolgimento collegamento Dahlander		giri/min	<b>I</b>

Motor type	Rated output	Speed	Current	Efficiency	Power factor	Torque	Starting current	Starting torque	Noise level	Moment of inertia	Mass	CESI Certificates	Class T
Moteur type	Puissance	Vitesse	Intensité	Rendement	Facteur de puissance	Couple	Intensité démarrage	Couple démarrage	Niveau de bruit	Moment d'inertie	Masse	CESI Certificat	Classe T
Motor Typ	Leistung	Drehzahl	Strom	Wirkungsgrad	Leistungs-faktor	Moment	Anlauf-strom	Anlauf-moment	Schalldruck-pegel	Trägheits-moment	Masse	CESI Konformitäts-Bescheinigung	Klasse T
Tipo de motor	Potencia proporcionada	Velocidad	Corriente	Rendimiento	Factor de potencia	Par	Corriente de arranque	Par de arranque	Nivel de ruido	Momento de inercia	Peso	Certificados CESI	Clase T
Tipo motore	Potenza resa	Velocità	Corrente	Rendimento	Fattore potenza	Coppia	Corrente avviamento	Coppia avviamento	Rumorosità	Momento d'inerzia	Massa	Certificato CESI	Classe T

IIB		IIC		P <sub>n</sub> [kW]	n [1/min]	I <sub>n</sub> [A]	η [%]	cos φ	M <sub>n</sub> [Nm]	I <sub>a</sub> /I <sub>n</sub>	M <sub>a</sub> /M <sub>n</sub>	[dB(A)]		J ▼ [kgm <sup>2</sup> ]	m [kg]	IIB		IIC		◆
Ex d	Ex de	Ex d	Ex de									Lw	Lp			standard	★	standard	★	
<b>AB40 63 B 24</b>	AB45 63 B 24	<b>AC40 63 B 24</b>	AC45 63 B 24	0.24 0.07	2740 1360	0.86 0.20	60 73	0.68 0.71	0.8 0.5	3.4 2.6	2.0 1.8	52	44	0.0001	16	01 ATEX 102	02 ATEX 044X	01 ATEX 103	02 ATEX 045X	4
<b>AB40 71 A 24</b>	AB45 71 A 24	<b>AC40 71 A 24</b>	AC45 71 A 24	0.37 0.09	2882 1450	1.07 0.36	69 67	0.73 0.55	1.2 0.6	3.6 2.9	2.0 2.0	56	48	0.0004	19	01 ATEX 102	02 ATEX 044X	01 ATEX 103	02 ATEX 045X	4
<b>AB40 71 B 24</b>	AB45 71 B 24	<b>AC40 71 B 24</b>	AC45 71 B 24	0.50 0.14	2810 1380	1.50 0.42	67 72	0.72 0.70	1.7 1.0	3.8 3.0	1.8 2.0	56	48	0.0004	19	01 ATEX 102	02 ATEX 044X	01 ATEX 103	02 ATEX 045X	4
<b>AB40 80 A 24</b>	AB45 80 A 24	<b>AC40 80 A 24</b>	AC45 80 A 24	0.75 0.18	2820 1400	1.90 0.48	70 70	0.80 0.76	2.5 1.2	4.0 3.6	1.7 2.1	59	51	0.0006	26	01 ATEX 102	02 ATEX 044X	01 ATEX 103	02 ATEX 045X	4
<b>AB40 80 B 24</b>	AB45 80 B 24	<b>AC40 80 B 24</b>	AC45 80 B 24	1.10 0.25	2800 1380	2.60 0.71	75 66	0.82 0.76	3.8 1.7	4.2 3.7	1.8 2.0	59	51	0.0008	26	01 ATEX 102	02 ATEX 044X	01 ATEX 103	02 ATEX 045X	4
<b>AB40 90 S 24</b>	AB45 90 S 24	<b>AC40 90 S 24</b>	AC45 90 S 24	1.50 0.37	2780 1400	3.20 1.00	81 68	0.84 0.78	5.2 2.5	4.5 3.9	1.9 2.1	62	54	0.0012	33	01 ATEX 102	02 ATEX 044X	01 ATEX 103	02 ATEX 045X	4
<b>AB40 90 L 24</b>	AB45 90 L 24	<b>AC40 90 L 24</b>	AC45 90 L 24	2.00 0.51	2760 1380	4.30 1.30	77 68	0.88 0.82	7.0 3.5	4.3 4.0	1.8 2.2	62	54	0.0015	33	01 ATEX 102	02 ATEX 044X	01 ATEX 103	02 ATEX 045X	4
<b>AB40 100 LA 24</b>	AB45 100 LA 24	<b>AC40 100 LA 24</b>	AC45 100 LA 24	2.60 0.62	2810 1410	5.60 1.60	75 69	0.89 0.81	8.8 4.2	7.7 7.0	2.2 2.0	63	55	0.0029	46	01 ATEX 102	02 ATEX 044X	01 ATEX 103	02 ATEX 045X	4
<b>AB40 100 LB 24</b>	AB45 100 LB 24	<b>AC40 100 LB 24</b>	AC45 100 LB 24	3.30 0.75	2870 1480	7.70 2.20	78 57	0.80 0.85	11.0 4.8	5.6 5.1	2.2 2.0	63	55	0.0029	46	01 ATEX 102	02 ATEX 044X	01 ATEX 103	02 ATEX 045X	4
<b>AB40 112 M 24</b>	AB45 112 M 24	<b>AC40 112 M 24</b>	AC45 112 M 24	4.41 1.10	2930 1450	8.90 2.30	81 82	0.88 0.83	14.4 7.2	7.9 6.9	2.5 2.7	68	60	0.0074	65	02 ATEX 122	02 ATEX 124X	02 ATEX 123	02 ATEX 125X	4
<b>AB40 132 S 24</b>	AB45 132 S 24	<b>AC40 132 S 24</b>	AC45 132 S 24	6.50 2.00	2910 1450	12.50 4.80	83 75	0.90 0.80	21.3 13.2	6.2 6.0	2.1 1.9	72	64	0.0150	95	02 ATEX 122	02 ATEX 124X	02 ATEX 123	02 ATEX 125X	4
<b>AB40 132 M 24</b>	AB45 132 M 24	<b>AC40 132 M 24</b>	AC45 132 M 24	8.50 2.50	2945 1460	16.70 5.50	89 88	0.82 0.74	27.6 16.4	6.8 6.5	2.2 2.2	75	67	0.0178	95	02 ATEX 122	02 ATEX 124X	02 ATEX 123	02 ATEX 125X	4
<b>AB40 132 ML 24</b>	AB45 132 ML 24	<b>AC40 132 ML 24</b>	AC45 132 ML 24	9.20 2.80	2910 1440	17.50 5.70	90 87	0.84 0.82	30.2 18.6	6.9 6.6	2.3 2.2	75	67	0.0216	105	02 ATEX 122	02 ATEX 124X	02 ATEX 123	02 ATEX 125X	4
<b>AB40 160 M 24</b>	AB45 160 M 24	<b>AC40 160 M 24</b>	AC45 160 M 24	12.00 3.00	2935 1445	26.00 8.00	75 67	0.89 0.81	39.3 19.9	6.2 4.4	3.4 2.1	77	69	0.0360	180	02 ATEX 122	02 ATEX 124X	02 ATEX 123	02 ATEX 125X	4
<b>AB40 160 L 24</b>	AB45 160 L 24	<b>AC40 160 L 24</b>	AC45 160 L 24	16.00 4.40	2945 1455	29.60 8.90	87 87	0.90 0.82	51.6 29.0	7.4 7.0	2.0 1.9	77	69	0.0534	195	02 ATEX 122	02 ATEX 124X	02 ATEX 123	02 ATEX 125X	4
<b>AB40 180 M 24</b>	AB45 180 M 24	<b>AC40 180 M 24</b>	AC45 180 M 24	18.00 5.00	2965 1465	37.00 11.40	79 75	0.89 0.85	58.0 32.6	8.3 7.1	2.6 2.3	79	70	0.0750	230	06 ATEX 074	Pending	06 ATEX 073	Pending	4
<b>AB40 180 L 24</b>	AB45 180 L 24	<b>AC40 180 L 24</b>	AC45 180 L 24	24.00 6.00	2960 1480	44.50 11.80	90 89	0.87 0.83	77.4 39.0	9.6 9.6	3.3 3.1	79	70	0.0750	245	06 ATEX 074	Pending	06 ATEX 073	Pending	4
<b>AB40 200 LB 24</b>	AB45 200 LB 24	<b>AC40 200 LB 24</b>	AC45 200 LB 24	30.00 8.00	2970 1480	51.20 15.60	92 88	0.92 0.86	96.5 52.2	7.3 7.2	2.0 1.9	82	72	0.1449	315	06 ATEX 074	Pending	06 ATEX 073	Pending	4
<b>AB40 225 S 24</b>	AB45 225 S 24	<b>AC40 225 S 24</b>	AC45 225 S 24	37.00 9.20	2960 1460	68.00 21.00	86 74	0.91 0.86	119.4 60.2	7.3 7.0	2.1 2.0	84	73	0.1714	355	06 ATEX 074	Pending	06 ATEX 073	Pending	4
<b>AB40 225 M 24</b>	AB45 225 M 24	<b>AC40 225 M 24</b>	AC45 225 M 24	44.00 11.50	2970 1480	78.00 21.80	91 91	0.90 0.84	141.5 74.3	9.0 8.4	2.6 2.4	84	73	0.2656	380	06 ATEX 074	Pending	06 ATEX 073	Pending	4
<b>AB40 250 M 24</b>	AB45 250 M 24	<b>AC40 250 M 24</b>	AC45 250 M 24	51.00 13.50	2970 1475	93.00 26.50	89 87	0.89 0.85	164.0 87.4	6.5 6.2	2.2 1.8	86	75	0.2809	450	06 ATEX 074	Pending	06 ATEX 073	Pending	4
<b>AB40 280 S 24</b>	AB45 280 S 24	<b>AC40 280 S 24</b>	AC45 280 S 24	70.00 25.00	2960 1480	130.80 49.40	91 85	0.85 0.86	225.8 161.3	9.4 8.2	2.8 2.7	82	70	0.5200	890	08 ATEX 012	---	00 ATEX 053	01 ATEX 003X	4
<b>AB40 280 M 24</b>	AB45 280 M 24	<b>AC40 280 M 24</b>	AC45 280 M 24	86.00 31.00	2960 1480	158.80 63.50	91 84	0.86 0.84	277.5 200.0	9.2 8.0	2.8 2.6	82	70	0.6300	916	08 ATEX 012	---	00 ATEX 053	01 ATEX 003X	4
<b>AB40 315 S 24</b>	AB45 315 S 24	<b>AC40 315 S 24</b>	AC45 315 S 24	100.00 36.00	2965 1485	181.50 75.50	91 83	0.87 0.83	322.1 231.5	9.4 8.0	2.9 2.9	85	71	0.7000	971	08 ATEX 012	---	00 ATEX 053	01 ATEX 003X	4
<b>AB40 315 M 24</b>	AB45 315 M 24	<b>AC40 315 M 24</b>	AC45 315 M 24	110.00 40.00	2970 1485	196.30 83.90	92 84	0.88 0.82	353.7 257.2	9.5 8.1	2.9 2.8	85	71	0.7500	948	08 ATEX 012	---	00 ATEX 053	01 ATEX 003X	4
<b>AB40 315 LA 24</b>	AB45 315 LA 24	<b>AC40 315 LA 24</b>	AC45 315 LA 24	○	○	○	○	○	○	○	○	○	○	○	○	08 ATEX 021	---	07 ATEX 073	---	4
<b>AB40 315 LB 24</b>	AB45 315 LB 24	<b>AC40 315 LB 24</b>	AC45 315 LB 24	○	○	○	○	○	○	○	○	○	○	○	○	08 ATEX 021	---	07 ATEX 073	---	4
<b>AB40 315 LC 24</b>	AB45 315 LC 24	<b>AC40 315 LC 24</b>	AC45 315 LC 24	○	○	○	○	○	○	○	○	○	○	○	○	08 ATEX 021	---	07 ATEX 073	---	4

○ Data not indicated is supplied on request - Les données qui ne sont pas indiquées sont fournies sur demande - Die nicht angegebenen Daten werden auf Anfrage geliefert - Los datos que no se han precisado se pueden comunicar cuando se solicite - I dati non indicati sono forniti su richiesta

▶ - ▼ - ★ - ◆ - see the notes in section 4.1 - voir remarques dans la section 4.1 - siehe Anmerkung in Abschnitt 4.1 - véase notas en la sección 4.1 - vedi note di sezione 4.1

<b>GB</b>	Three-phase motors	<b>II 2G</b> <b>II 2GD</b>	<b>2</b>	Speeds	Rated data at	direct on line start	For centrifugal machines (quadratic torque) - 1 winding Dahlander-connected	<b>1500</b> <b>750</b>	rpm	<b>GB</b>
<b>F</b>	Moteurs triphasés			Vitesses	Données nominales à	démarrage direct	Pour machines centrifuges (couple quadratique) - 1 enroulement couplage Dahlander		tours/min	<b>F</b>
<b>D</b>	Drehstrom Motoren			Drehzahlen	Betriebsdaten bei	Direkteinschaltung	Für Zentrifugalmaschinen (quadratisches Gegenmoment) - 1 Wicklung / Schaltung Dahlander		U/min	<b>D</b>
<b>E</b>	Motores trifásicos			Velocidades	Datos nominales	arranque directo	Para máquinas centrifugas (par cuadrático) - 1 devanado con conexión Dahlander		rev/min	<b>E</b>
<b>I</b>	Motori trifase			Velocità	Dati nominali a	avviamento diretto	Per macchine centrifughe (coppia quadratica) - 1 avvolgimento collegamento Dahlander		giri/min	<b>I</b>

Motor type	Rated output	Speed	Current	Efficiency	Power factor	Torque	Starting current	Starting torque	Noise level	Moment of inertia	Mass	CESI Certificates	Class T
Moteur type	Puissance	Vitesse	Intensité	Rendement	Facteur de puissance	Couple	Intensité démarrage	Couple démarrage	Niveau de bruit	Moment d'inertie	Masse	CESI Certificat	Classe T
Motor Typ	Leistung	Drehzahl	Strom	Wirkungsgrad	Leistungs-faktor	Moment	Anlauf-strom	Anlauf-moment	Schalldruck-pegel	Trägheits-moment	Masse	CESI Konformitäts-Bescheinigung	Klasse T
Tipo de motor	Potencia proporcionada	Velocidad	Corriente	Rendimiento	Factor de potencia	Par	Corriente de arranque	Par de arranque	Nivel de ruido	Momento de inercia	Peso	Certificados CESI	Clase T
Tipo motore	Potenza resa	Velocità	Corrente	Rendimento	Fattore potenza	Coppia	Corrente avviamento	Coppia avviamento	Rumorosità	Momento d'inerzia	Massa	Certificato CESI	Classe T

IIB		IIC		P <sub>n</sub> [kW]	n [1/min]	I <sub>n</sub> [A]	η [%]	cos φ	M <sub>n</sub> [Nm]	I <sub>a</sub> /I <sub>n</sub>	M <sub>a</sub> /M <sub>n</sub>	[dB(A)]		J ▼ [kgm <sup>2</sup> ]	m [kg]	IIB		IIC		◆
Ex d	Ex de	Ex d	Ex de									Lw	Lp			standard	★	standard	★	
<b>AB40 71 A 48</b>	AB45 71 A 48	<b>AC40 71 A 48</b>	AC45 71 A 48	0.20 0.05	1420 700	0.82 0.39	50 32	0.71 0.59	1.4 0.7	3.5 1.7	1.8 1.4	48	40	0.0009	19	01 ATEX 102	02 ATEX 044X	01 ATEX 103	02 ATEX 045X	4
<b>AB40 71 B 48</b>	AB45 71 B 48	<b>AC40 71 B 48</b>	AC45 71 B 48	0.30 0.07	1390 680	0.95 0.44	58 34	0.78 0.70	2.1 1.0	3.6 1.8	1.8 1.6	48	40	0.0009	19	01 ATEX 102	02 ATEX 044X	01 ATEX 103	02 ATEX 045X	4
<b>AB40 80 A 48</b>	AB45 80 A 48	<b>AC40 80 A 48</b>	AC45 80 A 48	0.45 0.10	1450 710	1.40 0.66	68 40	0.69 0.55	3.0 1.4	5.1 2.6	2.6 2.8	49	41	0.0013	26	01 ATEX 102	02 ATEX 044X	01 ATEX 103	02 ATEX 045X	4
<b>AB40 80 B 48</b>	AB45 80 B 48	<b>AC40 80 B 48</b>	AC45 80 B 48	0.65 0.14	1420 695	1.67 0.69	70 47	0.80 0.63	4.4 1.9	4.3 2.5	1.8 2.0	49	41	0.0013	26	01 ATEX 102	02 ATEX 044X	01 ATEX 103	02 ATEX 045X	4
<b>AB40 90 S 48</b>	AB45 90 S 48	<b>AC40 90 S 48</b>	AC45 90 S 48	0.90 0.22	1420 690	2.40 0.95	76 50	0.72 0.65	6.1 3.0	4.2 2.4	1.9 1.8	53	45	0.0020	33	01 ATEX 102	02 ATEX 044X	01 ATEX 103	02 ATEX 045X	4
<b>AB40 90 L 48</b>	AB45 90 L 48	<b>AC40 90 L 48</b>	AC45 90 L 48	1.20 0.30	1440 700	3.25 1.50	77 56	0.70 0.52	8.0 4.1	4.4 2.7	2.0 1.8	53	45	0.0026	33	01 ATEX 102	02 ATEX 044X	01 ATEX 103	02 ATEX 045X	4
<b>AB40 100 LA 48</b>	AB45 100 LA 48	<b>AC40 100 LA 48</b>	AC45 100 LA 48	1.90 0.44	1410 700	4.70 1.90	74 58	0.79 0.58	13.0 6.2	4.2 2.4	1.8 1.6	60	52	0.0053	46	01 ATEX 102	02 ATEX 044X	01 ATEX 103	02 ATEX 045X	4
<b>AB40 100 LB 48</b>	AB45 100 LB 48	<b>AC40 100 LB 48</b>	AC45 100 LB 48	2.20 0.55	1405 695	5.30 2.00	73 63	0.82 0.64	15.0 7.6	4.9 3.0	2.0 1.7	60	52	0.0053	46	01 ATEX 102	02 ATEX 044X	01 ATEX 103	02 ATEX 045X	4
<b>AB40 112 M 48</b>	AB45 112 M 48	<b>AC40 112 M 48</b>	AC45 112 M 48	3.00 0.75	1420 710	6.80 2.50	75 64	0.85 0.68	20.3 10.1	5.0 3.1	2.1 1.8	62	54	0.0103	65	02 ATEX 122	02 ATEX 124X	02 ATEX 123	02 ATEX 125X	4
<b>AB40 132 S 48</b>	AB45 132 S 48	<b>AC40 132 S 48</b>	AC45 132 S 48	4.41 1.10	1445 710	9.30 3.90	86 74	0.80 0.56	29.3 15.0	5.9 3.5	2.3 1.8	66	58	0.0250	95	02 ATEX 122	02 ATEX 124X	02 ATEX 123	02 ATEX 125X	4
<b>AB40 132 MB 48</b>	AB45 132 MB48	<b>AC40 132 MB 48</b>	AC45 132 MB48	5.90 1.50	1460 710	12.90 5.30	82 69	0.81 0.61	38.6 20.4	6.4 4.0	2.1 1.7	66	58	0.0324	95	02 ATEX 122	02 ATEX 124X	02 ATEX 123	02 ATEX 125X	4
<b>AB40 132 L 48</b>	AB45 132 L 48	<b>AC40 132 L 48</b>	AC45 132 L 48	7.50 1.85	1440 710	16.00 6.20	83 72	0.82 0.60	49.8 25.0	6.9 4.4	2.0 1.8	66	58	0.0405	105	02 ATEX 122	02 ATEX 124X	02 ATEX 123	02 ATEX 125X	4
<b>AB40 160 M 48</b>	AB45 160 M 48	<b>AC40 160 M 48</b>	AC45 160 M 48	8.80 2.50	1470 730	18.00 7.75	89 82	0.80 0.58	57.7 33.1	7.0 4.0	2.1 1.8	70	62	0.0627	180	02 ATEX 122	02 ATEX 124X	02 ATEX 123	02 ATEX 125X	4
<b>AB40 160 L 48</b>	AB45 160 L 48	<b>AC40 160 L 48</b>	AC45 160 L 48	12.00 3.20	1470 715	25.10 10.50	89 79	0.77 0.56	77.7 42.5	7.0 4.1	2.1 2.0	70	62	0.0801	195	02 ATEX 122	02 ATEX 124X	02 ATEX 123	02 ATEX 125X	4
<b>AB40 180 M 48</b>	AB45 180 M 48	<b>AC40 180 M 48</b>	AC45 180 M 48	16.00 4.00	1465 730	30.50 12.50	89 66	0.85 0.70	103.5 53.5	7.0 4.6	2.6 2.0	73	64	0.1270	230	06 ATEX 074	Pending	06 ATEX 073	Pending	4
<b>AB40 180 L 48</b>	AB45 180 L 48	<b>AC40 180 L 48</b>	AC45 180 L 48	22.00 5.50	1470 732	45.00 17.20	89 82	0.80 0.56	143.0 71.8	6.7 4.2	3.7 3.1	73	64	0.1488	245	06 ATEX 074	Pending	06 ATEX 073	Pending	4
<b>AB40 200 LB 48</b>	AB45 200 LB 48	<b>AC40 200 LB 48</b>	AC45 200 LB 48	26.00 6.00	1480 735	49.40 15.60	92 91	0.83 0.61	168.2 78.2	6.8 4.4	2.3 2.2	75	65	0.2436	315	06 ATEX 074	Pending	06 ATEX 073	Pending	4
<b>AB40 225 S 48</b>	AB45 225 S 48	<b>AC40 225 S 48</b>	AC45 225 S 48	32.00 8.10	1470 725	60.00 19.00	92 91	0.86 0.68	207.9 105.2	6.7 4.6	2.4 2.3	79	68	0.3762	355	06 ATEX 074	Pending	06 ATEX 073	Pending	4
<b>AB40 225 M 48</b>	AB45 225 M 48	<b>AC40 225 M 48</b>	AC45 225 M 48	37.00 9.20	1475 730	67.00 22.00	92 90	0.87 0.67	238.0 120.0	7.0 4.8	2.8 2.4	79	68	0.4451	380	06 ATEX 074	Pending	06 ATEX 073	Pending	4
<b>AB40 250 M 48</b>	AB45 250 M 48	<b>AC40 250 M 48</b>	AC45 250 M 48	45.00 11.00	1475 730	87.00 27.90	94 91	0.80 0.63	291.3 143.3	5.8 5.0	2.4 2.2	79	68	0.4611	450	06 ATEX 074	Pending	06 ATEX 073	Pending	4
<b>AB40 280 S 48</b>	AB45 280 S 48	<b>AC40 280 S 48</b>	AC45 280 S 48	69.00 20.00	1480 720	128.90 49.80	91 88	0.85 0.66	445.2 265.3	5.4 3.8	1.9 1.5	72	60	0.9500	890	08 ATEX 012	---	00 ATEX 053	01 ATEX 003X	4
<b>AB40 280 M 48</b>	AB45 280 M 48	<b>AC40 280 M 48</b>	AC45 280 M 48	83.00 25.00	1480 720	155.10 63.90	91 87	0.85 0.65	535.6 331.6	5.5 3.7	1.8 1.4	72	60	1.1200	916	08 ATEX 012	---	00 ATEX 053	01 ATEX 003X	4
<b>AB40 315 S 48</b>	AB45 315 S 48	<b>AC40 315 S 48</b>	AC45 315 S 48	94.00 28.00	1485 725	173.70 70.50	92 87	0.85 0.66	604.5 368.8	5.4 3.8	1.9 1.5	75	61	1.2700	971	08 ATEX 012	---	00 ATEX 053	01 ATEX 003X	4
<b>AB40 315 M 48</b>	AB45 315 M 48	<b>AC40 315 M 48</b>	AC45 315 M 48	100.00 30.00	1485 725	182.60 75.80	92 88	0.86 0.65	643.1 395.2	4.9 3.8	1.8 1.4	75	61	1.3300	984	08 ATEX 012	---	00 ATEX 053	01 ATEX 003X	4
<b>AB40 315 LA 48</b>	AB45 315 LA 48	<b>AC40 315 LA 48</b>	AC45 315 LA 48	○	○	○	○	○	○	○	○	○	○	○	○	08 ATEX 021	---	07 ATEX 073	---	4
<b>AB40 315 LB 48</b>	AB45 315 LB 48	<b>AC40 315 LB 48</b>	AC45 315 LB 48	○	○	○	○	○	○	○	○	○	○	○	○	08 ATEX 021	---	07 ATEX 073	---	4
<b>AB40 315 LC 48</b>	AB45 315 LC 48	<b>AC40 315 LC 48</b>	AC45 315 LC 48	○	○	○	○	○	○	○	○	○	○	○	○	08 ATEX 021	---	07 ATEX 073	---	4

○ Data not indicated is supplied on request - Les données qui ne sont pas indiquées sont fournies sur demande - Die nicht angegebenen Daten werden auf Anfrage geliefert - Los datos que no se han precisado se pueden comunicar cuando se solicite - I dati non indicati sono forniti su richiesta

◆ - ▼ - ★ - ◆ - see the notes in section 4.1 - voir remarques dans la section 4.1 - siehe Anmerkung in Abschnitt 4.1 - véase notas en la sección 4.1 - vedi note di sezione 4.1



<b>GB</b>	Three-phase motors	<b>II 2G</b>	<b>2</b>	Speeds	Rated data at	<b>400 V</b>	<b>50 Hz</b>	direct on line start	For centrifugal machines (quadratic torque) - 2 separate windings	rpm	<b>GB</b>
<b>F</b>	Moteurs triphasés	<b>II 2GD</b>	<b>2</b>	Vitesses	Données nominales à	<b>400 V</b>	<b>50 Hz</b>	démarrage direct	Pour machines centrifuges (couple quadratique) - 2 enroulements séparés	tours/min	<b>F</b>
<b>D</b>	Drehstrom Motoren	<b>II 2GD</b>	<b>2</b>	Drehzahlen	Betriebsdaten bei	<b>400 V</b>	<b>50 Hz</b>	Direkteinschaltung	Für Zentrifugalmaschinen (quadratisches Gegenmoment) - 2 getrennte Wicklungen	U/min	<b>D</b>
<b>E</b>	Motores trifásicos	<b>II 2GD</b>	<b>2</b>	Velocidades	Datos nominales	<b>400 V</b>	<b>50 Hz</b>	arranque directo	Para máquinas centrifugas (par cuadrático) - 2 devanados separados	rev/min	<b>E</b>
<b>I</b>	Motori trifase	<b>II 2GD</b>	<b>2</b>	Velocità	Dati nominali a	<b>400 V</b>	<b>50 Hz</b>	avviamento diretto	Per macchine centrifughe (coppia quadratica) - 2 avvolgimenti separati	giri/min	<b>I</b>

Motor type	Rated output	Speed	Current	Efficiency	Power factor	Torque	Starting current	Starting torque	Noise level	Moment of inertia	Mass	CESI Certificates	Class T
Moteur type	Puissance	Vitesse	Intensité	Rendement	Facteur de puissance	Couple	Intensité démarrage	Couple démarrage	Niveau de bruit	Moment d'inertie	Masse	CESI Certificat	Classe T
Motor Typ	Leistung	Drehzahl	Strom	Wirkungsgrad	Leistungs-faktor	Moment	Anlauf-strom	Anlauf-moment	Schalldruck-pegel	Trägheits-moment	Masse	CESI Konformitäts-Bescheinigung	Klasse T
Tipo de motor	Potencia proporcionada	Velocidad	Corriente	Rendimiento	Factor de potencia	Par	Corriente de arranque	Par de arranque	Nivel de ruido	Momento de inercia	Peso	Certificados CESI	Clase T
Tipo motore	Potenza resa	Velocità	Corrente	Rendimento	Fattore potenza	Coppia	Corrente avviamento	Coppia avviamento	Rumorosità	Momento d'inerzia	Massa	Certificato CESI	Classe T

IIB		IIC		P <sub>n</sub> [kW]	n [1/min]	I <sub>n</sub> ▷ [A]	η [%]	cos φ	M <sub>n</sub> [Nm]	I <sub>a</sub> /I <sub>n</sub>	M <sub>a</sub> /M <sub>n</sub>	[dB(A)]		J ▼ [kgm <sup>2</sup> ]	m [kg]	IIB		IIC		◆
Ex d	Ex de	Ex d	Ex de									Lw	Lp			standard	★	standard	★	
AB40 71 B 46	AB45 71 B 46	AC40 71 B 46	AC45 71 B 46	0.30 0.10	1390 905	0.95 0.45	56 46	0.82 0.76	2.1 1.1	4.0 2.8	2.1 1.9	50 42	42	0.0009	19	01 ATEX 102	02 ATEX 044X	01 ATEX 103	02 ATEX 045X	4
AB40 80 A 46	AB45 80 A 46	AC40 80 A 46	AC45 80 A 46	0.44 0.13	1430 930	1.27 0.44	71 59	0.70 0.70	2.9 1.3	4.2 3.8	1.6 1.2	53 45	45	0.0013	26	01 ATEX 102	02 ATEX 044X	01 ATEX 103	02 ATEX 045X	4
AB40 80 B 46	AB45 80 B 46	AC40 80 B 46	AC45 80 B 46	0.59 0.18	1430 950	1.60 0.67	74 56	0.72 0.69	4.0 1.8	4.0 3.6	1.7 1.9	53 45	45	0.0013	26	01 ATEX 102	02 ATEX 044X	01 ATEX 103	02 ATEX 045X	4
AB40 90 S 46	AB45 90 S 46	AC40 90 S 46	AC45 90 S 46	0.90 0.30	1410 960	2.45 1.65	64 54	0.83 0.49	6.2 3.0	4.2 3.0	2.0 1.5	54 46	46	0.0020	33	01 ATEX 102	02 ATEX 044X	01 ATEX 103	02 ATEX 045X	4
AB40 90 L 46	AB45 90 L 46	AC40 90 L 46	AC45 90 L 46	1.15 0.40	1395 920	3.20 1.65	70 51	0.77 0.69	8.3 4.2	4.3 3.1	2.0 1.6	54 46	46	0.0026	33	01 ATEX 102	02 ATEX 044X	01 ATEX 103	02 ATEX 045X	4
AB40 100 LA 46	AB45 100 LA 46	AC40 100 LA 46	AC45 100 LA 46	1.80 0.60	1430 955	4.10 1.90	79 70	0.80 0.65	12.0 6.0	5.2 4.0	2.0 1.7	63 55	55	0.0053	46	01 ATEX 102	02 ATEX 044X	01 ATEX 103	02 ATEX 045X	4
AB40 100 LB 46	AB45 100 LB 46	AC40 100 LB 46	AC45 100 LB 46	2.20 0.70	1425 950	4.70 2.10	80 73	0.85 0.66	14.7 7.0	5.0 3.8	1.9 1.6	63 55	55	0.0053	46	01 ATEX 102	02 ATEX 044X	01 ATEX 103	02 ATEX 045X	4
AB40 112 M 46	AB45 112 M 46	AC40 112 M 46	AC45 112 M 46	3.00 0.90	1455 960	6.90 2.30	76 75	0.83 0.75	19.7 9.0	6.0 4.2	1.9 1.8	65 57	57	0.0103	65	02 ATEX 122	02 ATEX 124X	02 ATEX 123	02 ATEX 125X	4
AB40 132 S 46	AB45 132 S 46	AC40 132 S 46	AC45 132 S 46	4.00 1.20	1460 980	9.50 4.60	79 68	0.77 0.55	26.2 11.7	6.5 5.1	2.0 1.7	68 60	60	0.0250	95	02 ATEX 122	02 ATEX 124X	02 ATEX 123	02 ATEX 125X	4
AB40 132 MA 46	AB45 132 MA 46	AC40 132 MA 46	AC45 132 MA 46	4.80 1.40	1455 965	11.50 5.10	75 68	0.80 0.58	31.5 13.9	6.9 5.4	1.9 1.8	68 60	60	0.0324	95	02 ATEX 122	02 ATEX 124X	02 ATEX 123	02 ATEX 125X	4
AB40 132 MB 46	AB45 132 MB 46	AC40 132 MB 46	AC45 132 MB 46	5.50 1.70	1460 960	13.00 6.50	76 63	0.80 0.60	36.0 16.9	5.7 4.9	1.9 2.0	68 60	60	0.0324	105	02 ATEX 122	02 ATEX 124X	02 ATEX 123	02 ATEX 125X	4
AB40 132 L 46	AB45 132 L 46	AC40 132 L 46	AC45 132 L 46	6.60 2.00	1470 980	15.50 8.00	88 76	0.70 0.49	42.9 20.0	6.9 5.4	1.8 1.8	68 60	60	0.0405	105	02 ATEX 122	02 ATEX 124X	02 ATEX 123	02 ATEX 125X	4
AB40 160 M 46	AB45 160 M 46	AC40 160 M 46	AC45 160 M 46	7.50 2.50	1470 985	15.35 6.67	86 83	0.82 0.66	48.9 24.4	7.4 6.0	2.1 2.2	72 64	64	0.0627	180	02 ATEX 122	02 ATEX 124X	02 ATEX 123	02 ATEX 125X	4
AB40 160 L 46	AB45 160 L 46	AC40 160 L 46	AC45 160 L 46	11.00 3.30	1460 980	23.00 9.50	82 71	0.84 0.71	71.9 32.2	7.1 6.2	2.2 2.3	72 64	64	0.0801	195	02 ATEX 122	02 ATEX 124X	02 ATEX 123	02 ATEX 125X	4
AB40 180 M 46	AB45 180 M 46	AC40 180 M 46	AC45 180 M 46	15.00 5.20	1450 960	31.50 21.00	81 85	0.85 0.57	98.8 51.7	6.9 6.0	1.8 1.6	76 67	67	0.1270	230	06 ATEX 074	Pending	06 ATEX 073	Pending	4
AB40 180 L 46	AB45 180 L 46	AC40 180 L 46	AC45 180 L 46	18.50 6.25	1450 965	36.00 22.00	84 66	0.88 0.62	121.8 61.8	7.0 6.2	1.8 1.6	76 67	67	0.1488	245	06 ATEX 074	Pending	06 ATEX 073	Pending	4
AB40 200 LA 46	AB45 200 LA 46	AC40 200 LA 46	AC45 200 LA 46	21.00 7.50	1460 970	41.00 16.50	85 82	0.87 0.80	137.4 73.8	6.9 6.5	2.0 1.9	79 69	69	0.2436	295	06 ATEX 074	Pending	06 ATEX 073	Pending	4
AB40 200 LB 46	AB45 200 LB 46	AC40 200 LB 46	AC45 200 LB 46	26.00 8.80	1465 970	48.50 24.50	89 83	0.87 0.63	169.5 86.6	6.4 6.2	2.1 2.1	79 69	69	0.2436	315	06 ATEX 074	Pending	06 ATEX 073	Pending	4
AB40 225 S 46	AB45 225 S 46	AC40 225 S 46	AC45 225 S 46	31.00 11.00	1470 975	58.00 23.00	88 82	0.88 0.84	201.4 107.7	6.5 6.0	2.2 2.1	81 70	70	0.3762	355	06 ATEX 074	Pending	06 ATEX 073	Pending	4
AB40 225 M 46	AB45 225 M 46	AC40 225 M 46	AC45 225 M 46	36.00 12.00	1475 990	70.00 30.00	88 86	0.84 0.68	233.0 117.0	6.1 6.0	2.1 2.0	81 70	70	0.4451	380	06 ATEX 074	Pending	06 ATEX 073	Pending	4
AB40 250 M 46	AB45 250 M 46	AC40 250 M 46	AC45 250 M 46	38.00 14.00	1485 985	72.66 28.89	89 85	0.85 0.83	244.5 136.0	5.6 5.4	1.9 1.9	81 70	70	0.4611	450	06 ATEX 074	Pending	06 ATEX 073	Pending	4
AB40 280 S 46	AB45 280 S 46	AC40 280 S 46	AC45 280 S 46	65.00 25.00	1480 980	123.00 63.60	92 86	0.83 0.66	419.4 243.6	8.1 6.4	2.9 2.8	77 65	65	0.9500	890	08 ATEX 012	---	00 ATEX 053	01 ATEX 003X	4
AB40 280 M 46	AB45 280 M 46	AC40 280 M 46	AC45 280 M 46	80.00 30.00	1485 995	145.20 76.30	96 91	0.84 0.63	518.0 291.6	8.2 6.2	2.8 2.9	77 65	65	1.1200	916	08 ATEX 012	---	00 ATEX 053	01 ATEX 003X	4
AB40 315 S 46	AB45 315 S 46	AC40 315 S 46	AC45 315 S 46	90.00 35.00	1485 985	170.30 89.40	92 87	0.83 0.65	578.8 339.3	8.3 6.4	2.9 3.0	79 65	65	1.2700	971	08 ATEX 012	---	00 ATEX 053	01 ATEX 003X	4
AB40 315 M 46	AB45 315 M 46	AC40 315 M 46	AC45 315 M 46	95.00 37.00	1485 990	179.80 92.10	92 88	0.83 0.66	610.9 356.9	8.2 6.4	2.8 3.0	79 65	65	1.3300	984	08 ATEX 012	---	00 ATEX 053	01 ATEX 003X	4
AB40 315 LA 46	AB45 315 LA 46	AC40 315 LA 46	AC45 315 LA 46	○	○	○	○	○	○	○	○	○	○	○	○	08 ATEX 021	---	07 ATEX 073	---	4
AB40 315 LB 46	AB45 315 LB 46	AC40 315 LB 46	AC45 315 LB 46	○	○	○	○	○	○	○	○	○	○	○	○	08 ATEX 021	---	07 ATEX 073	---	4
AB40 315 LC 46	AB45 315 LC 46	AC40 315 LC 46	AC45 315 LC 46	○	○	○	○	○	○	○	○	○	○	○	○	08 ATEX 021	---	07 ATEX 073	---	4

○ Data not indicated is supplied on request - Les données qui ne sont pas indiquées sont fournies sur demande - Die nicht angegebenen Daten werden auf Anfrage geliefert - Los datos que no se han precisado se pueden comunicar cuando se solicite - I dati non indicati sono forniti su richiesta

▷ - ▼ - ★ - ◆ - see the notes in section 4.1 - voir remarques dans la section 4.1 - siehe Anmerkung in Abschnitt 4.1 - véase notas en la sección 4.1 - vedi note di sezione 4.1

GB	Three-phase motors				Speeds		Rated data at			direct on line start	For centrifugal machines (quadratic torque) - 2 separate windings						rpm	GB		
F	Moteurs triphasés				Vitesses	Données nominales à			démarrage direct	Pour machines centrifuges (couple quadratique) - 2 enroulements séparés						tours/min	F			
D	Drehstrom Motoren				Drehzahlen	Betriebsdaten bei			Direkteinschaltung	Für Zentrifugalmaschinen (quadratisches Gegenmoment) - 2 getrennte Wicklungen						U/min	D			
E	Motores trifásicos				Velocidades	Datos nominales			arranque directo	Para máquinas centrifugas (par cuadrático) - 2 devanados separados						rev/min	E			
I	Motori trifase				Velocità	Dati nominali a			avviamento diretto	Per macchine centrifughe (coppia quadratica) - 2 avvolgimenti separati						giri/min	I			
4.	II 2G				400 V					1000										
4.3	II 2GD				50 Hz					750										
Motor type	Rated output		Speed	Current	Efficiency	Power factor	Torque	Starting current	Starting torque	Noise level	Moment of inertia	Mass	CESI Certificates				Class T			
Moteur type	Puissance		Vitesse	Intensité	Rendement	Facteur de puissance	Couple	Intensité démarrage	Couple démarrage	Niveau de bruit	Moment d'inertie	Masse	CESI Certificat				Classe T			
Motor Typ	Leistung		Drehzahl	Strom	Wirkungsgrad	Leistungsfaktor	Moment	Anlaufstrom	Anlaufmoment	Schalldruckpegel	Trägheitsmoment	Masse	CESI Konformitäts-Bescheinigung				Klasse T			
Tipo de motor	Potencia proporcionada		Velocidad	Corriente	Rendimiento	Factor de potencia	Par	Corriente de arranque	Par de arranque	Nivel de ruido	Momento de inercia	Peso	Certificados CESI				Clase T			
Tipo motore	Potenza resa		Velocità	Corrente	Rendimento	Fattore potenza	Coppia	Corrente avviamento	Coppia avviamento	Rumorosità	Momento d'inerzia	Massa	Certificato CESI				Classe T			
IIB		IIC		P <sub>n</sub> [kW]	n [1/min]	I <sub>n</sub> [A]	η [%]	cos φ	M <sub>n</sub> [Nm]	I <sub>a</sub> /I <sub>n</sub>	M <sub>a</sub> /M <sub>n</sub>	[dB(A)]		J ▼ [kgm²]	m [kg]	IIB		IIC		◆
Ex d	Ex de	Ex d	Ex de									L <sub>w</sub>	L <sub>p</sub>			standard	★	standard	★	
AB4080 A 68	AB45 80 A 68	AC40 80 A 68	AC45 80 A 68	0.33	930	1.15	59	0.68	3.4	3.2	1.8	49	41	0.0027	26	01 ATEX 102	02 ATEX 044X	01 ATEX 103	02 ATEX 045X	4
AB4080 B 68	AB45 80 B 68	AC40 80 B 68	AC45 80 B 68	0.09	700	0.64	33	0.51	1.2	2.0	1.4	49	41	0.0027	26	01 ATEX 102	02 ATEX 044X	01 ATEX 103	02 ATEX 045X	4
AB4090 S 68	AB45 90 S 68	AC40 90 S 68	AC45 90 S 68	0.40	930	1.20	61	0.76	4.1	3.0	1.7	49	41	0.0027	26	01 ATEX 102	02 ATEX 044X	01 ATEX 103	02 ATEX 045X	4
AB4090 L 68	AB45 90 L 68	AC40 90 L 68	AC45 90 L 68	0.12	680	0.65	44	0.63	1.7	2.1	1.3	49	41	0.0027	26	01 ATEX 102	02 ATEX 044X	01 ATEX 103	02 ATEX 045X	4
AB4090 S 68	AB45 90 S 68	AC40 90 S 68	AC45 90 S 68	0.48	895	1.54	52	0.89	5.3	3.1	1.8	53	45	0.0034	33	01 ATEX 102	02 ATEX 044X	01 ATEX 103	02 ATEX 045X	4
AB4090 L 68	AB45 90 L 68	AC40 90 L 68	AC45 90 L 68	0.19	705	0.82	52	0.65	2.6	2.2	1.4	53	45	0.0034	33	01 ATEX 102	02 ATEX 044X	01 ATEX 103	02 ATEX 045X	4
AB40100 LA 68	AB45 100 LA 68	AC40 100 LA 68	AC45 100 LA 68	0.66	895	2.00	60	0.80	7.0	3.3	1.9	53	45	0.0049	33	01 ATEX 102	02 ATEX 044X	01 ATEX 103	02 ATEX 045X	4
AB40100 LB 68	AB45 100 LB 68	AC40 100 LB 68	AC45 100 LB 68	0.25	700	1.20	51	0.59	3.4	2.4	1.6	53	45	0.0049	33	01 ATEX 102	02 ATEX 044X	01 ATEX 103	02 ATEX 045X	4
AB40100 LA 68	AB45 100 LA 68	AC40 100 LA 68	AC45 100 LA 68	0.88	960	2.90	66	0.66	8.8	4.1	1.8	60	52	0.0088	46	01 ATEX 102	02 ATEX 044X	01 ATEX 103	02 ATEX 045X	4
AB40100 LB 68	AB45 100 LB 68	AC40 100 LB 68	AC45 100 LB 68	0.37	715	1.80	47	0.63	4.9	3.6	1.7	60	52	0.0088	46	01 ATEX 102	02 ATEX 044X	01 ATEX 103	02 ATEX 045X	4
AB40112 M 68	AB45 112 M 68	AC40 112 M 68	AC45 112 M 68	1.10	950	3.40	69	0.68	11.1	4.0	1.6	60	52	0.0088	46	01 ATEX 102	02 ATEX 044X	01 ATEX 103	02 ATEX 045X	4
AB40112 M 68	AB45 112 M 68	AC40 112 M 68	AC45 112 M 68	0.44	710	2.10	49	0.62	5.9	3.5	1.4	60	52	0.0088	46	01 ATEX 102	02 ATEX 044X	01 ATEX 103	02 ATEX 045X	4
AB40132 S 68	AB45 132 S 68	AC40 132 S 68	AC45 132 S 68	1.50	970	4.60	74	0.64	14.8	4.5	2.0	62	54	0.0172	65	02 ATEX 122	02 ATEX 124X	02 ATEX 123	02 ATEX 125X	4
AB40132 MA 68	AB45 132 MA 68	AC40 132 MA 68	AC45 132 MA 68	0.75	725	3.30	60	0.54	9.9	3.6	1.6	62	54	0.0172	65	02 ATEX 122	02 ATEX 124X	02 ATEX 123	02 ATEX 125X	4
AB40132 MB 68	AB45 132 MB 68	AC40 132 MB 68	AC45 132 MB 68	2.20	950	5.70	75	0.74	22.1	4.5	2.2	66	58	0.0323	95	02 ATEX 122	02 ATEX 124X	02 ATEX 123	02 ATEX 125X	4
AB40132 MA 68	AB45 132 MA 68	AC40 132 MA 68	AC45 132 MA 68	0.88	710	3.30	60	0.64	11.8	3.8	1.7	66	58	0.0395	95	02 ATEX 122	02 ATEX 124X	02 ATEX 123	02 ATEX 125X	4
AB40132 MB 68	AB45 132 MB 68	AC40 132 MB 68	AC45 132 MB 68	3.00	960	7.00	76	0.81	29.8	4.9	2.0	66	58	0.0395	95	02 ATEX 122	02 ATEX 124X	02 ATEX 123	02 ATEX 125X	4
AB40160 M 68	AB45 160 M 68	AC40 160 M 68	AC45 160 M 68	1.20	730	4.80	59	0.61	15.7	3.9	2.0	66	58	0.0506	105	02 ATEX 122	02 ATEX 124X	02 ATEX 123	02 ATEX 125X	4
AB40160 L 68	AB45 160 L 68	AC40 160 L 68	AC45 160 L 68	3.70	965	8.90	79	0.76	36.6	5.1	2.2	66	58	0.0506	105	02 ATEX 122	02 ATEX 124X	02 ATEX 123	02 ATEX 125X	4
AB40200 LA 68	AB45 200 LA 68	AC40 200 LA 68	AC45 200 LA 68	1.50	715	5.00	64	0.68	20.0	3.9	2.1	66	58	0.0506	105	02 ATEX 122	02 ATEX 124X	02 ATEX 123	02 ATEX 125X	4
AB40200 LB 68	AB45 200 LB 68	AC40 200 LB 68	AC45 200 LB 68	5.50	980	12.50	87	0.73	53.6	5.6	2.2	70	62	0.0919	180	02 ATEX 122	02 ATEX 124X	02 ATEX 123	02 ATEX 125X	4
AB40225 S 68	AB45 225 S 68	AC40 225 S 68	AC45 225 S 68	2.50	730	6.80	83	0.64	32.7	4.3	2.3	70	62	0.1218	195	02 ATEX 122	02 ATEX 124X	02 ATEX 123	02 ATEX 125X	4
AB40225 M 68	AB45 225 M 68	AC40 225 M 68	AC45 225 M 68	7.50	970	17.40	83	0.75	73.9	5.8	2.1	70	62	0.1218	195	02 ATEX 122	02 ATEX 124X	02 ATEX 123	02 ATEX 125X	4
AB40250 M 68	AB45 250 M 68	AC40 250 M 68	AC45 250 M 68	4.00	728	11.60	78	0.64	52.8	4.0	2.0	70	62	0.1218	195	02 ATEX 122	02 ATEX 124X	02 ATEX 123	02 ATEX 125X	4
AB40280 S 68	AB45 280 S 68	AC40 280 S 68	AC45 280 S 68	9.00	965	20.00	83	0.78	89.1	5.8	2.3	73	64	0.2067	230	06 ATEX 074	Pending	06 ATEX 073	Pending	4
AB40280 M 68	AB45 280 M 68	AC40 280 M 68	AC45 280 M 68	4.50	725	11.00	80	0.74	59.3	4.3	2.2	73	64	0.2067	245	06 ATEX 074	Pending	06 ATEX 073	Pending	4
AB40315 S 68	AB45 315 S 68	AC40 315 S 68	AC45 315 S 68	10.00	960	23.50	79	0.78	99.5	5.6	2.1	73	64	0.2067	245	06 ATEX 074	Pending	06 ATEX 073	Pending	4
AB40315 M 68	AB45 315 M 68	AC40 315 M 68	AC45 315 M 68	5.20	720	13.00	80	0.72	69.0	4.1	2.0	73	64	0.2067	245	06 ATEX 074	Pending	06 ATEX 073	Pending	4
AB40315 LA 68	AB45 315 LA 68	AC40 315 LA 68	AC45 315 LA 68	13.00	970	29.50	81	0.79	128.0	5.3	2.0	75	65	0.2986	295	06 ATEX 074	Pending	06 ATEX 073	Pending	4
AB40315 LB 68	AB45 315 LB 68	AC40 315 LB 68	AC45 315 LB 68	6.50	720	15.50	82	0.74	86.2	4.7	2.1	75	65	0.2986	295	06 ATEX 074	Pending	06 ATEX 073	Pending	4
AB40315 LC 68	AB45 315 LC 68	AC40 315 LC 68	AC45 315 LC 68	16.00	970	36.00	80	0.80	157.5	5.2	1.9	75	65	0.3503	315	06 ATEX 074	Pending	06 ATEX 073	Pending	4
AB40315 LA 68	AB45 315 LA 68	AC40 315 LA 68	AC45 315 LA 68	8.10	725	21.00	72	0.77	106.7	4.6	2.0	75	65	0.3503	315	06 ATEX 074	Pending	06 ATEX 073	Pending	4
AB40315 LB 68	AB45 315 LB 68	AC40 315 LB 68	AC45 315 LB 68	20.00	980	41.00	88	0.80	194.9	5.0	2.3	79	68	0.6965	355	06 ATEX 074	Pending	06 ATEX 073	Pending	4
AB40315 LC 68	AB45 315 LC 68	AC40 315 LC 68	AC45 315 LC 68	10.00	730	24.50	76	0.78	130.8	4.9	2.2	79	68	0.6965	355	06 ATEX 074	Pending	06 ATEX 073	Pending	4
AB40315 LA 68	AB45 315 LA 68	AC40 315 LA 68	AC45 315 LA 68	23.00	988	46.40	91	0.79	223.9	4.7	2.0	79	68	0.6965	380	06 ATEX 074	Pending	06 ATEX 073	Pending	4
AB40315 LB 68	AB45 315 LB 68	AC40 315 LB 68	AC45 315 LB 68	11.00	737	25.20	89	0.72	144.8	4.6	2.1	79	68	0.6965	380	06 ATEX 074	Pending	06 ATEX 073	Pending	4
AB40315 LB 68	AB45 315 LB 68	AC40 315 LB 68	AC45 315 LB 68	26.00	980	53.00	89	0.80	253.3	4.8	1.8	79	68	0.7216	450	06 ATEX 074	Pending	06 ATEX 073	Pending	4
AB40315 LB 68	AB45 315 LB 68	AC40 315 LB 68	AC45 315 LB 68	13.00	730	31.50	75	0.80	170.1	4.5	1.7	79	68	0.7216	450	06 ATEX 074	Pending	06 ATEX 073	Pending	4
AB40315 LB 68	AB45 315 LB 68	AC40 315 LB 68	AC45 315 LB 68	40.00	985	81.40	91	0.78	387.8	7.3	3.1	72	60	1.1400	890	08 ATEX 012	---	00 ATEX 053	01 ATEX 003X	4
AB40315 LB 68	AB45 315 LB 68	AC40 315 LB 68	AC45 315 LB 68	16.00	740	38.20	84	0.72	206.5	5.3	2.7	72	60	1.3600	916	08 ATEX 012	---	00 ATEX 053	01 ATEX 003X	4
AB40315 LB 68	AB45 315 LB 68	AC40 315 LB 68	AC45 315 LB 68	48.00	990	99.50	90	0.78	464.5	7.5	3.0	72	60	1.3600	916	08 ATEX 012	---	00 ATEX 053	01 ATEX 003X	4
AB40315 LB 68	AB45 315 LB 68	AC40 315 LB 68	AC45 315 LB 68	20.00	740	53.40	86	0.63	258.0	5.2	2.7	72	60	1.3600	916	08 ATEX 012	---	00 ATEX 053	01 ATEX 003X	4
AB40315 LB 68	AB45 315 LB 68	AC40 315 LB 68	AC45 315 LB 68	58.00	990	119.60	91	0.77	559.5	7.9	3.4	75	61	1.6300	971	08 ATEX 012	---	00 ATEX 053	01 ATEX 003X	4
AB40315 LB 68	AB45 315 LB 68	AC40 315 LB 68	AC45 315 LB 68	24.00	742	56.90	87	0.70	308.9	5.4	2.9	75	61	1.6300</						



GB F D E I	4. 4.4	Single-phase motors	II 2G II 2GD	1	Speed	Rated data at	230 V 50 Hz	direct on line start	3000 rpm 1500 U/min 1000 rev/min 1000 giri/min	GB F D E I
		Moteurs monophasé			Vitesse	Données nominales à		démarrage direct		
		Einphasen Motoren			Drehzahl	Betriebsdaten bei		Direkteinschaltung		
		Motores monofásicos			Velocidad	Datos nominales		arranque directo		
		Motori monofase			Velocità	Dati nominali a		avviamento diretto		

Motor type	Rated output	Speed	Current	Efficiency	Power factor	Torque	Starting current	Starting torque	Capacitor	Sound pressure	Moment of inertia	Mass	CESI Certificates	Class T
Moteur type	Puissance	Vitesse	Intensité	Rendement	Facteur de puissance	Couple	Intensité démarrage	Couple démarrage	Condensateur	Pression sonore	Moment d'inertie	Masse	CESI Certificat	Classe T
Motor Typ	Leistung	Drehzahl	Strom	Wirkungsgrad	Leistungs-faktor	Moment	Anlauf-strom	Anlauf-moment	Konden-sator	Geräusch-werte	Trägheits-moment	Masse	CESI Konformitäts-Bescheinigung	Klasse T
Tipo de motor	Potencia proporcionada	Velocidad	Corriente	Rendimiento	Factor de potencia	Par	Corriente de arranque	Par de arranque	Condensador	Presión acústica	Momento de inercia	Peso	Certificados CESI	Clase T
Tipo motore	Potenza resa	Velocità	Corrente	Rendimento	Fattore potenza	Coppia	Corrente avviamento	Coppia avviamento	Condensatore	Pressione sonora	Momento d'inerzia	Massa	Certificato CESI	Classe T

IIB		IIC		P <sub>n</sub> [kW]	n [1/min]	I <sub>n</sub> [A]	η [%]	cos φ	M <sub>n</sub> [Nm]	I <sub>a</sub> /I <sub>n</sub>	M <sub>a</sub> /M <sub>n</sub>	C [μF]	[dB(A)]		J [kgm <sup>2</sup> ]	m [kg]	IIB		IIC		◆
Ex d	Ex de	Ex d	Ex de										L <sub>w</sub>	L <sub>p</sub>			standard	★	standard	★	
AB10 63 A 2	AB15 63 A 2	AC10 63 A 2	AC15 63 A 2	0.10	2750	1.30	35	0.95	0.3	3.3	0.6	6.3	60	52	0.0001	16	01 ATEX 102	02 ATEX 044X	01 ATEX 103	02 ATEX 045X	4
AB10 63 B 2	AB15 63 B 2	AC10 63 B 2	AC15 63 B 2	0.15	2750	1.30	53	0.95	0.5	3.8	0.6	8.0	60	52	0.0001	16	01 ATEX 102	02 ATEX 044X	01 ATEX 103	02 ATEX 045X	4
AB10 71 A 2	AB15 71 A 2	AC10 71 A 2	AC15 71 A 2	0.20	2800	2.60	48	0.92	0.7	3.6	0.7	10.0	66	58	0.0004	19	01 ATEX 102	02 ATEX 044X	01 ATEX 103	02 ATEX 045X	4
AB10 71 B 2	AB15 71 B 2	AC10 71 B 2	AC15 71 B 2	0.40	2730	2.90	63	0.95	1.4	2.7	0.7	12.5	66	58	0.0004	19	01 ATEX 102	02 ATEX 044X	01 ATEX 103	02 ATEX 045X	4
AB10 80 A 2	AB15 80 A 2	AC10 80 A 2	AC15 80 A 2	0.55	2720	5.40	53	0.82	1.9	2.5	0.6	16.0	70	62	0.0006	26	01 ATEX 102	02 ATEX 044X	01 ATEX 103	02 ATEX 045X	4
AB10 80 B 2	AB15 80 B 2	AC10 80 B 2	AC15 80 B 2	0.75	2790	5.30	63	0.97	2.6	4.5	0.8	20.0	70	62	0.0008	26	01 ATEX 102	02 ATEX 044X	01 ATEX 103	02 ATEX 045X	4
AB10 90 S 2	AB15 90 S 2	AC10 90 S 2	AC15 90 S 2	1.10	2750	7.80	63	0.97	3.8	4.4	0.7	45.0	77	69	0.0012	33	01 ATEX 102	02 ATEX 044X	01 ATEX 103	02 ATEX 045X	4
AB10 90 L 2	AB15 90 L 2	AC10 90 L 2	AC15 90 L 2	1.50	2800	8.90	74	0.98	5.1	4.9	0.7	60.0	77	69	0.0015	33	01 ATEX 102	02 ATEX 044X	01 ATEX 103	02 ATEX 045X	4
AB10 100 LA 2	AB15 100 LA 2	AC10 100 LA 2	AC15 100 LA 2	2.20	2800	15.50	65	0.95	7.5	5.0	0.6	60.0	80	72	0.0029	46	01 ATEX 102	02 ATEX 044X	01 ATEX 103	02 ATEX 045X	4
AB10 100 LB 2	AB15 100 LB 2	AC10 100 LB 2	AC15 100 LB 2	3.00	2800	18.00	74	0.98	10.2	5.0	0.6	80.0	80	72	0.0036	46	01 ATEX 102	02 ATEX 044X	01 ATEX 103	02 ATEX 045X	4
AB10 63 A 4	AB15 63 A 4	AC10 63 A 4	AC15 63 A 4	0.09	1360	1.10	39	0.90	0.6	3.2	0.6	6.3	52	44	0.0002	16	01 ATEX 102	02 ATEX 044X	01 ATEX 103	02 ATEX 045X	4
AB10 63 B 4	AB15 63 B 4	AC10 63 B 4	AC15 63 B 4	0.13	1350	1.30	55	0.90	1.1	3.0	0.6	8.0	52	44	0.0002	16	01 ATEX 102	02 ATEX 044X	01 ATEX 103	02 ATEX 045X	4
AB10 71 A 4	AB15 71 A 4	AC10 71 A 4	AC15 71 A 4	0.15	1380	1.70	42	0.90	1.0	3.2	0.7	10.0	56	48	0.0006	19	01 ATEX 102	02 ATEX 044X	01 ATEX 103	02 ATEX 045X	4
AB10 71 B 4	AB15 71 B 4	AC10 71 B 4	AC15 71 B 4	0.25	1380	2.30	48	0.97	1.7	3.4	0.7	12.5	56	48	0.0009	19	01 ATEX 102	02 ATEX 044X	01 ATEX 103	02 ATEX 045X	4
AB10 80 A 4	AB15 80 A 4	AC10 80 A 4	AC15 80 A 4	0.35	1410	3.30	49	0.96	2.4	3.8	0.7	20.0	59	51	0.0009	26	01 ATEX 102	02 ATEX 044X	01 ATEX 103	02 ATEX 045X	4
AB10 80 B 4	AB15 80 B 4	AC10 80 B 4	AC15 80 B 4	0.45	1420	4.30	53	0.85	3.0	3.8	0.8	25.0	59	51	0.0013	26	01 ATEX 102	02 ATEX 044X	01 ATEX 103	02 ATEX 045X	4
AB10 80 L 4	AB15 80 L 4	AC10 80 L 4	AC15 80 L 4	0.55	1420	4.90	56	0.87	3.7	3.9	0.7	30.0	59	51	0.0014	26	01 ATEX 102	02 ATEX 044X	01 ATEX 103	02 ATEX 045X	4
AB10 90 S 4	AB15 90 S 4	AC10 90 S 4	AC15 90 S 4	0.75	1420	5.90	56	0.97	5.2	2.1	1.0	30.0	62	54	0.0020	33	01 ATEX 102	02 ATEX 044X	01 ATEX 103	02 ATEX 045X	4
AB10 90 L 4	AB15 90 L 4	AC10 90 L 4	AC15 90 L 4	1.10	1430	7.20	73	0.91	7.3	4.0	0.6	35.0	62	54	0.0026	33	01 ATEX 102	02 ATEX 044X	01 ATEX 103	02 ATEX 045X	4
AB10 100 LA 4	AB15 100 LA 4	AC10 100 LA 4	AC15 100 LA 4	1.30	1370	8.10	72	0.98	9.0	3.2	0.5	35.0	63	55	0.0043	46	01 ATEX 102	02 ATEX 044X	01 ATEX 103	02 ATEX 045X	4
AB10 100 LB 4	AB15 100 LB 4	AC10 100 LB 4	AC15 100 LB 4	1.60	1400	10.00	71	0.98	11.1	2.6	0.5	40.0	63	55	0.0053	46	01 ATEX 102	02 ATEX 044X	01 ATEX 103	02 ATEX 045X	4
AB10 71 A 6	AB15 71 A 6	AC10 71 A 6	AC15 71 A 6	0.10	900	1.50	36	0.80	1.1	2.6	0.5	8.0	50	42	0.0007	19	01 ATEX 102	02 ATEX 044X	01 ATEX 103	02 ATEX 045X	4
AB10 71 B 6	AB15 71 B 6	AC10 71 B 6	AC15 71 B 6	0.15	850	1.40	50	0.93	1.7	2.8	0.5	10.0	50	42	0.0010	19	01 ATEX 102	02 ATEX 044X	01 ATEX 103	02 ATEX 045X	4
AB10 80 A 6	AB15 80 A 6	AC10 80 A 6	AC15 80 A 6	0.20	910	2.70	40	0.81	2.1	2.9	0.6	16.0	53	45	0.0022	26	01 ATEX 102	02 ATEX 044X	01 ATEX 103	02 ATEX 045X	4
AB10 80 B 6	AB15 80 B 6	AC10 80 B 6	AC15 80 B 6	0.30	930	3.00	53	0.82	3.1	3.0	0.6	25.0	53	45	0.0027	26	01 ATEX 102	02 ATEX 044X	01 ATEX 103	02 ATEX 045X	4
AB10 90 S 6	AB15 90 S 6	AC10 90 S 6	AC15 90 S 6	0.55	920	4.30	63	0.88	5.7	3.0	0.6	30.0	54	46	0.0034	33	01 ATEX 102	02 ATEX 044X	01 ATEX 103	02 ATEX 045X	4
AB10 90 L 6	AB15 90 L 6	AC10 90 L 6	AC15 90 L 6	0.75	910	6.10	60	0.88	7.9	3.1	0.7	35.0	54	46	0.0049	33	01 ATEX 102	02 ATEX 044X	01 ATEX 103	02 ATEX 045X	4
AB10 100 LB 6	AB15 100 LB 6	AC10 100 LB 6	AC15 100 LB 6	1.10	920	8.00	65	0.92	11.4	3.2	0.7	75.0	63	55	0.0088	46	01 ATEX 102	02 ATEX 044X	01 ATEX 103	02 ATEX 045X	4

<b>GB</b>		Motors energized by inverter	<b>II 2G</b>	Self-ventilated IC 411	Self-ventilated IC 411 or forced ventilation IC 416 <sup>◆</sup>	Forced ventilation IC 416	Self-ventilated IC 411	Pole	<b>GB</b>
<b>F</b>		Moteurs alimentés par variateur		Autoventilés IC 411	Autoventilés IC 411 ou ventilation assistée IC 416 <sup>◆</sup>	Ventilation assistée IC 416	Autoventilés IC 411	Pôles	<b>F</b>
<b>D</b>		Motoren mit Umrichter-versorgung		Eigenbelüftet IC 411	Eigenbelüftet IC 411 oder fremdbelüftet IC 416 <sup>◆</sup>	Fremdbelüftung IC 416	Eigenbelüftet IC 411	Pole	<b>D</b>
<b>E</b>	<b>4.</b>	Motores alimentados con inverter	<b>II 2GD</b>	Autoventilados IC 411	Autoventilados IC 411 o ventilación asistida IC 416 <sup>◆</sup>	Ventilación asistida IC 416	Autoventilados IC 411	Polos	<b>E</b>
<b>I</b>	<b>4.5</b>	Motori alimentati da inverter		Autoventilati IC 411	Autoventilati IC 411 o ventilazione assistita IC 416 <sup>◆</sup>	Ventilazione assistita IC 416	Autoventilati IC 411	<b>2</b> Poli	<b>I</b>

		400 V, 50 Hz		[Hz] 5 ÷ 50 range 1 ÷ 10 [1/min] 300 ÷ 3000			[Hz] 10 ÷ 50 range 1 ÷ 5 [1/min] 600 ÷ 3000			[Hz] 25 ÷ 50 range 1 ÷ 2 [1/min] 1500 ÷ 3000			[Hz] 50 ÷ 87 range 10 ÷ 17 [1/min] 3000 ÷ 5200			[Hz] 50 ÷ 87 range 10 ÷ 17 [1/min] 3000 ÷ 5200			[Hz] 5 ÷ 50 range 1 ÷ 10 [1/min] 300 ÷ 3000			[Hz] 5 ÷ 50 range 1 ÷ 10 [1/min] 300 ÷ 3000								
Motor type		Mains connection		Constant torque			Constant torque			Constant torque			Constant torque - Weakened flux			Constant torque - Constant flux Δ connection			Constant torque - Forced Ventilation			Quadratic torque ●			Class T					
Moteur type		Alimentation de secteur		Couple constant			Couple constant			Couple constant			Couple constant - Flux affaibli			Couple constant - Flux constant raccordement Δ			Couple constant - Ventilation Assistée			Couple quadratique ●			Classe T					
Motor Typ		Netzeinspeisung		Konstantes Gegenmoment			Konstantes Gegenmoment			Konstantes Gegenmoment			Konstantes Gegenmoment - Feldschwächbetrieb			Konstantes Gegenmoment - konstanter Strom Δ-Verbindung			Konstantes Gegenmoment - Fremdbelüftung			Quadratisches Gegenmoment ●			Klasse T					
Tipo de motor		Alimentación desde la red		Par constante			Par constante			Par constante			Par constante - Flujo debilitado			Par constante - Flujo constante conexión Δ			Par constante - Ventilación asistida			Par cuadrático ●			Clase T					
Tipo motore		Alimentazione da rete		Coppia costante			Coppia costante			Coppia costante			Coppia costante-Flusso indebolito			Coppia costante - Flusso costante collegamento Δ			Coppia costante - Ventilazione Assistita			Coppia quadratica ●			Classe T					
IIB		IIC		P <sub>n</sub> [kW]	I <sub>n</sub> [A]	P [kW]	M [Nm]	I [A]	P [kW]	M [Nm]	I [A]	P [kW]	M [Nm]	I [A]	P [kW]	M [Nm]	I [A]	P [kW]	M [Nm]	I [A]	P [kW]	M [Nm]	I [A]	P [kW]	M [Nm]	I [A]	P [kW]	M [Nm]	I [A]	◆
Ex d	Ex de	Ex d	Ex de																											
<b>AB70 63 B 2</b>	AB75 63 B 2	<b>AC70 63 B 2</b>	AC75 63 B 2	0.25	0.85	0.02-0.16	0.54	0.53	0.04-0.18	0.61	0.60	0.11-0.22	0.76	0.74	0.13-0.23	0.46	0.44	0.21-0.36	0.70	1.18	---	---	---	0.25	0.85	0.83	4			
<b>AB70 71 A 2</b>	AB75 71 A 2	<b>AC70 71 A 2</b>	AC75 71 A 2	0.37	1.10	0.02-0.24	0.81	0.71	0.05-0.27	0.91	0.80	0.16-0.33	1.12	0.99	0.20-0.35	0.68	0.60	0.30-0.53	1.04	1.60	---	---	---	0.37	1.26	1.12	4			
<b>AB70 71 B 2</b>	AB75 71 B 2	<b>AC70 71 B 2</b>	AC75 71 B 2	0.55	1.40	0.04-0.35	1.19	0.91	0.08-0.40	1.34	1.02	0.24-0.49	1.65	1.26	0.30-0.51	1.00	0.76	0.45-0.79	1.53	2.02	---	---	---	0.55	1.86	1.42	4			
<b>AB70 80 A 2</b>	AB75 80 A 2	<b>AC70 80 A 2</b>	AC75 80 A 2	0.75	1.90	0.05-0.48	1.64	1.29	0.11-0.54	1.84	1.45	0.33-0.67	2.28	1.80	0.40-0.70	1.37	1.08	0.62-1.07	2.10	2.89	---	---	---	0.75	2.56	2.02	4			
<b>AB70 80 B 2</b>	AB75 80 B 2	<b>AC70 80 B 2</b>	AC75 80 B 2	1.10	2.60	0.07-0.70	2.38	1.67	0.16-0.79	2.67	1.88	0.49-0.98	3.31	2.32	0.59-1.03	1.99	1.40	0.90-1.57	3.05	3.73	---	---	---	1.10	3.71	2.61	4			
<b>AB70 90 S 2</b>	AB75 90 S 2	<b>AC70 90 S 2</b>	AC75 90 S 2	1.50	3.10	0.10-0.96	3.19	1.99	0.22-1.08	3.59	2.24	0.67-1.34	4.45	2.78	0.81-1.40	2.68	1.67	1.23-2.14	4.10	4.45	---	---	---	1.50	4.99	3.12	4			
<b>AB70 90 L 2</b>	AB75 90 L 2	<b>AC70 90 L 2</b>	AC75 90 L 2	2.20	4.80	0.14-1.41	4.77	3.08	0.32-1.58	5.36	3.47	0.98-1.96	6.64	4.29	1.18-2.06	4.00	2.59	1.81-3.15	6.12	6.88	---	---	---	2.20	7.45	4.82	4			
<b>AB70 100 LA 2</b>	AB75 100 LA 2	<b>AC70 100 LA 2</b>	AC75 100 LA 2	3.00	7.30	0.19-1.92	6.41	4.67	0.43-2.16	7.21	5.26	1.34-2.67	8.93	6.51	1.61-2.80	5.38	3.92	2.47-4.29	8.23	10.44	0.27-2.70	9.02	6.57	3.00	10.02	7.30	4			
															[Hz] 50 ÷ 70 ★ range 10 ÷ 14 [1/min] 3000 ÷ 4200			[Hz] 50 ÷ 70 ★ range 10 ÷ 14 [1/min] 3000 ÷ 4200												
<b>AB70 112 M 2</b>	AB70 112 M 2	<b>AC70 112 M 2</b>	AC75 112 M 2	4.00	8.70	0.30-2.60	8.40	5.60	0.60-2.90	9.50	6.30	1.80-3.60	11.70	7.80	3.00-4.10	9.80	6.50	3.90-5.40	12.80	14.90	0.40-3.60	11.90	7.90	4.00	13.20	8.80	4			
<b>AB70 132 SA 2</b>	AB75 132 SA 2	<b>AC70 132 SA 2</b>	AC75 132 SA 2	5.50	12.00	0.40-3.50	11.60	7.40	0.80-4.00	13.10	8.30	2.50-4.90	16.20	10.30	4.10-5.70	13.50	8.60	5.30-7.50	17.60	19.50	0.50-5.00	16.40	10.40	5.50	18.20	11.60	4			
<b>AB70 132 SB 2</b>	AB75 132 SB 2	<b>AC70 132 SB 2</b>	AC75 132 SB 2	7.50	15.00	0.50-4.80	15.80	9.60	1.10-5.40	17.70	10.80	3.30-6.70	21.90	13.40	5.60-7.80	18.20	11.10	7.30-10.20	23.90	25.30	0.70-6.80	22.20	13.50	7.50	24.60	15.00	4			
<b>AB70 132 MB 2</b>	AB75 132 MB 2	<b>AC70 132 MB 2</b>	AC75 132 MB 2	9.20	18.00	0.60-5.90	19.40	11.50	1.30-6.60	21.80	13.00	4.10-8.20	27.00	16.10	6.80-9.50	22.40	13.40	8.90-12.50	29.40	30.40	0.80-8.30	27.30	16.20	9.20	30.30	18.00	4			
<b>AB70 160 MA 2</b>	AB75 160 MA 2	<b>AC70 160 MA 2</b>	AC75 160 MA 2	11.00	20.60	0.70-7.00	23.00	13.10	1.60-7.90	25.80	14.80	4.90-9.80	32.00	18.30	8.10-11.40	26.50	15.20	10.70-14.90	34.80	34.60	1.00-9.90	32.30	18.50	11.00	35.90	20.50	4			
<b>AB70 160 MB 2</b>	AB75 160 MB 2	<b>AC70 160 MB 2</b>	AC75 160 MB 2	15.00	26.80	1.00-9.60	31.10	16.90	2.20-10.80	35.00	19.00	6.70-13.40	43.30	23.60	11.10-15.50	36.00	19.60	14.60-20.40	47.20	44.60	1.40-13.50	43.80	23.80	15.00	48.60	26.40	4			
<b>AB70 160 L 2</b>	AB75 160 L 2	<b>AC70 160 L 2</b>	AC75 160 L 2	18.50	32.80	1.20-11.80	38.40	20.90	2.70-13.30	43.20	23.50	8.20-16.50	53.50	29.00	13.70-19.20	44.40	24.10	17.90-25.10	58.20	55.00	1.70-16.70	54.00	29.30	18.50	60.00	32.60	4			
															[Hz] 50 ÷ 60 ★ range 10 ÷ 12 [1/min] 3000 ÷ 3600			[Hz] 50 ÷ 60 ★ range 10 ÷ 12 [1/min] 3000 ÷ 3600												
<b>AB70 180 M 2</b>	AB75 180 M 2	<b>AC70 180 M 2</b>	AC75 180 M 2	22.00	40.00	1.40-14.10	46.00	25.40	3.20-15.80	51.00	28.50	9.80-19.60	63.00	35.30	19.80-23.80	64.00	35.70	22.00-26.40	71.00	68.90	2.00-19.80	64.00	35.70	22.00	71.00	39.60	4			
<b>AB70 200 LA 2</b>	AB75 200 LA 2	<b>AC70 200 LA 2</b>	AC75 200 LA 2	30.00	55.00	1.90-19.20	62.00	35.20	4.30-21.60	69.00	39.60	13.40-26.70	86.00	49.00	27.00-32.40	87.00	49.50	30.00-36.00	96.00	95.70	2.70-27.00	87.00	49.50	30.00	96.00	55.00	4			
<b>AB70 200 LB 2</b>	AB75 200 LB 2	<b>AC70 200 LB 2</b>	AC75 200 LB 2	37.00	67.00	2.40-23.70	76.00	42.40	5.30-26.60	86.00	47.70	16.50-33.00	106.00	59.00	33.30-40.00	107.00	59.60	37.00-44.40	119.00	115.20	3.30-33.30	107.00	59.60	37.00	119.00	66.30	4			
<b>AB70 225 M 2</b>	AB75 225 M 2	<b>AC70 225 M 2</b>	AC75 225 M 2	45.00	82.00	2.90-28.80	92.00	52.00	6.50-32.40	104.00	58.50	20.00-40.10	129.00	72.30	40.50-48.60	130.00	73.10	42.70-51.30	137.00	134.20	4.10-40.50	130.00	73.10	45.00	144.00	81.20	4			
<b>AB70 250 M 2</b>	AB75 250 M 2	<b>AC70 250 M 2</b>	AC75 250 M 2	55.00	98.00	3.50-35.20	113.00	62.80	7.90-39.60	127.00	70.60	24.50-49.00	157.00	87.40	49.50-59.40	159.00	88.30	52.20-62.70	168.00	162.10	5.00-49.50	159.00	88.30	55.00	176.00	98.10	4			
<b>AB70 280 S 2</b>	AB75 280 S 2	<b>AC70 280 S 2</b>	AC75 280 S 2	75.00	132.00	4.60-46.40	149.00	81.00	10.10-50.70	163.00	88.50	31.70-63.40	203.00	110.70	63.70-76.50	204.00	111.30	67.50-81.00	216.00	205.00	6.40-63.70	204.00	111.30	73.50	240.00	131.00	4			
<b>AB70 280 M 2</b>	AB75 280 M 2	<b>AC70 280 M 2</b>	AC75 280 M 2	90.00	165.00	5.60-55.60	178.00	101.40	12.20-60.80	195.00	110.90	38.00-76.10	244.00	138.70	76.50-91.80	245.00	139.40	81.00-97.20	259.00	256.70	7.70-76.50	245.00	139.40	87.30	288.00	164.00	4			
<b>AB70 315 S 2</b>	AB75 315 S 2	<b>AC70 315 S 2</b>	AC75 315 S 2	110.00	139.00	6.80-68.00	218.00	118.50	14.90-74.40	238.00	129.60	46.50-91.00	298.00	162.10	93.50-112.20	300.00	163.00	99.00-118.80	317.00	300.10	9.40-93.50	300.00	163.00	105.60	353.00	191.80	4			
<b>AB70 315 LA 2</b>	AB75 315 LA 2	<b>AC70 315 LA 2</b>	AC75 315 LA 2	132.00	222.00	8.20-81.60	262.00	140.70	17.90-89.20	287.00	153.90	55.80-111.60	359.00	192.40	112.20-134.60	361.00	193.40	118.80-142.50	382.00	356.20	11.20-112.20	361.00	193.40	124.10	424.00	227.60	4			
<b>AB70 315 LB 2</b>	AB75 315 LB 2	<b>AC70 315 LB 2</b>	AC75 315 LB 2	160.00	269.00	9.90-98.90	317.00	166.00	21.60-108.20	346.00	181.50	67.60-135.30	433.00	227.00	136.00-163.20	435.00	228.20	144.00-172.80	461.00	420.30	13.60-136.00	435.00	228.20	147.20	512.00	268.60	4			
<b>AB70 315 LC 2</b>	AB75 315 LC 2	<b>AC70 315 LC 2</b>	AC75 315 LC 2	200.00	332.00	12.40-123.60	396.00	206.00	27.00-135.20	433.00	225.30	84.50-169.10	541.00	281.70	170.00-204.00	544.00	283.20	180.00-216.00	576.00	521.50	17.00-170.00	544.00	283.00	180.00	640.00	333.20	4			

Rounded values  
Valeurs arrondies  
Gerundete Werte  
Valores redondeado  
Valori arrotondati

◆ To reduce noise level, IC 416 is advisable (available from frame size 100)  
On conseille IC 416 pour réduire le bruit (disponible à partir de hauteur d'axe 100)  
Zur Lärmverringerung wird IC 416 empfohlen

<b>GB</b>		Motors energized by inverter		Self-ventilated IC 411		Self-ventilated IC 411 or forced ventilation IC 416	Forced ventilation IC 416	Self-ventilated IC 411		Pole	<b>GB</b>
<b>F</b>		Moteurs alimentés par variateur		Autoventilés IC 411		Autoventilés IC 411 ou ventilation assistée IC 416	Ventilation assistée IC 416	Autoventilés IC 411		Pôles	<b>F</b>
<b>D</b>		Motoren mit Umrichterversorgung		Eigenbelüftet IC 411		Eigenbelüftet IC 411 oder fremdbelüftet IC 416	Fremdbelüftung IC 416	Eigenbelüftet IC 411		Pole	<b>D</b>
<b>E</b>	<b>4.</b>	Motores alimentados con inverter	<b>II 2G</b>	Autoventilados IC 411		Autoventilados IC 411 o ventilación asistida IC 416	Ventilación asistida IC 416	Autoventilados IC 411		Polos	<b>E</b>
<b>I</b>	<b>4.5</b>	Motori alimentati da inverter	<b>II 2GD</b>	Autoventilati IC 411		Autoventilati IC 411 o ventilazione assistita IC 416	Ventilazione assistita IC 416	Autoventilati IC 411	<b>4</b>	Poli	<b>I</b>

		400 V, 50 Hz		[Hz] 5 ÷ 50 range 1 ÷ 10 [1/min] 150 ÷ 1500		[Hz] 10 ÷ 50 range 1 ÷ 5 [1/min] 300 ÷ 1500		[Hz] 25 ÷ 50 range 1 ÷ 2 [1/min] 750 ÷ 1500		[Hz] 50 ÷ 87 range 10 ÷ 17 [1/min] 1500 ÷ 2600		[Hz] 50 ÷ 87 range 10 ÷ 17 [1/min] 1500 ÷ 2600		[Hz] 5 ÷ 50 range 1 ÷ 10 [1/min] 150 ÷ 1500		[Hz] 5 ÷ 50 range 1 ÷ 10 [1/min] 150 ÷ 1500										
Motor type		Mains connection		Constant torque		Constant torque		Constant torque		Constant torque - Weakened flux		Constant torque - Constant flux Δ connection		Constant torque - Forced Ventilation		Quadratic torque ●		Class T								
Moteur type		Alimentation de secteur		Couple constant		Couple constant		Couple constant		Couple constant - Flux affaibli		Couple constant - Flux constant raccordement Δ		Couple constant - Ventilation Assistée		Couple quadratique ●		Classe T								
Motor Typ		Netzspeisung		Konstantes Gegenmoment		Konstantes Gegenmoment		Konstantes Gegenmoment		Konstantes Gegenmoment - Feldschwächbetrieb		Konstantes Gegenmoment - konstanter Strom Δ-Verbindung		Konstantes Gegenmoment - Fremdbelüftung		Quadratisches Gegenmoment ●		Klasse T								
Tipo de motor		Alimentación desde la red		Par constante		Par constante		Par constante		Par constante - Flujo debilitado		Par constante - Flujo constante conexión Δ		Par constante - Ventilación asistida		Par cuadrático ●		Clase T								
Tipo motore		Alimentazione da rete		Coppia costante		Coppia costante		Coppia costante		Coppia costante - Flusso indebolito		Coppia costante - Flusso costante collegamento Δ		Coppia costante - Ventilazione Assistita		Coppia quadratica ●		Classe T								

IIB		IIC		P <sub>n</sub> [kW]	I <sub>n</sub> [A]	P			M			I			P			M			I			P	M	I	P	M	I	◆
Ex d	Ex de	Ex d	Ex de			[kW]	[Nm]	[A]	[kW]	[Nm]	[A]	[kW]	[Nm]	[A]	[kW]	[Nm]	[A]	[kW]	[Nm]	[A]	[kW]	[Nm]	[A]							
AB70 63 A 4	AB75 63 A 4	AC70 63 A 4	AC75 63 A 4	0.12	0.62	0.01-0.08	0.53	0.34	0.02-0.09	0.60	0.38	0.05-0.11	0.74	0.48		0.06-0.11	0.45	0.29	0.10-0.17	0.68	0.76	---	---	---	0.12	0.83	0.53	4		
AB70 63 B 4	AB75 63 B 4	AC70 63 B 4	AC75 63 B 4	0.18	0.67	0.01-0.12	0.82	0.44	0.03-0.13	0.92	0.49	0.08-0.16	1.14	0.61		0.10-0.17	0.69	0.37	0.15-0.26	1.05	0.97	---	---	---	0.18	1.28	0.68	4		
AB70 71 A 4	AB75 71 A 4	AC70 71 A 4	AC75 71 A 4	0.25	0.80	0.02-0.16	1.11	0.49	0.04-0.18	1.25	0.56	0.11-0.22	1.55	0.69		0.13-0.23	0.93	0.41	0.21-0.36	1.43	1.10	---	---	---	0.25	1.74	0.77	4		
AB70 71 B 4	AB75 71 B 4	AC70 71 B 4	AC75 71 B 4	0.37	1.10	0.02-0.24	1.63	0.69	0.05-0.27	1.83	0.77	0.16-0.33	2.26	0.96		0.20-0.35	1.37	0.58	0.30-0.53	2.09	1.54	---	---	---	0.37	2.54	1.07	4		
AB70 80 A 4	AB75 80 A 4	AC70 80 A 4	AC75 80 A 4	0.55	1.60	0.04-0.35	2.44	1.04	0.08-0.40	2.74	1.17	0.24-0.49	3.39	1.44		0.30-0.51	2.04	0.87	0.45-0.79	3.13	2.32	---	---	---	0.55	3.81	1.62	4		
AB70 80 B 4	AB75 80 B 4	AC70 80 B 4	AC75 80 B 4	0.75	2.00	0.05-0.48	3.27	1.29	0.11-0.54	3.68	1.45	0.33-0.67	4.56	1.79		0.40-0.70	2.75	1.08	0.62-1.07	4.21	2.87	---	---	---	0.75	5.12	2.01	4		
AB70 90 S 4	AB75 90 S 4	AC70 90 S 4	AC75 90 S 4	1.10	2.80	0.07-0.70	4.80	1.75	0.16-0.79	5.40	1.97	0.49-0.98	6.69	2.43		0.59-1.03	4.03	1.47	0.90-1.57	6.17	3.91	---	---	---	1.10	7.50	2.73	4		
AB70 90 L 4	AB75 90 L 4	AC70 90 L 4	AC75 90 L 4	1.50	3.60	0.10-0.96	6.46	2.31	0.22-1.08	7.26	2.60	0.67-1.34	8.99	3.21		0.81-1.40	5.42	1.94	1.23-2.14	8.29	5.15	---	---	---	1.50	10.09	3.61	4		
AB70 100 LA 4	AB75 100 LA 4	AC70 100 LA 4	AC75 100 LA 4	2.20	5.25	0.14-1.41	9.42	3.34	0.32-1.58	10.60	3.76	0.98-1.96	13.12	4.65		1.18-2.06	7.91	2.80	1.81-3.15	12.10	7.46	0.20-1.98	13.25	4.70	2.20	14.72	5.22	4		
AB70 100 LB 4	AB75 100 LB 4	AC70 100 LB 4	AC75 100 LB 4	3.00	6.83	0.19-1.92	12.77	4.34	0.43-2.16	14.36	4.88	1.34-2.67	17.78	6.04		1.61-2.80	10.71	3.64	2.47-4.29	16.40	9.68	0.27-2.70	17.96	6.10	3.00	19.95	6.78	4		
AB70 112 M 4	AB75 112 M 4	AC70 112 M 4	AC75 112 M 4	4.00	8.20	0.30-2.60	17.00	5.10	0.60-2.90	19.10	5.80	1.80-3.60	23.60	7.20		2.20-3.70	14.30	4.30	3.30-5.70	21.80	11.50	0.40-3.60	23.90	7.20	4.00	26.50	8.00	4		
AB70 132 SB 4	AB75 132 SB 4	AC70 132 SB 4	AC75 132 SB 4	5.50	11.60	0.40-3.50	23.10	7.40	0.80-4.00	26.00	8.30	2.50-4.90	32.20	10.30		3.00-5.10	19.40	6.20	4.50-7.90	29.70	16.50	0.50-5.00	32.50	10.40	5.50	36.10	11.60	4		
AB70 132 MB 4	AB75 132 MB 4	AC70 132 MB 4	AC75 132 MB 4	7.50	16.50	0.50-4.80	31.60	10.50	1.10-5.40	35.60	11.80	3.30-6.70	44.00	14.60		4.00-7.00	26.50	8.80	6.20-10.70	40.60	23.30	0.70-6.80	44.50	14.70	7.50	49.40	16.30	4		
AB70 132 ML 4	AB75 132 ML 4	AC70 132 ML 4	AC75 132 ML 4	8.80	18.50	0.60-5.60	37.00	11.80	1.30-6.30	41.60	13.30	3.90-7.80	51.50	16.50		4.70-8.20	31.00	9.90	7.20-12.60	47.50	26.40	0.80-7.90	52.00	16.60	8.80	57.80	18.50	4		
AB70 160 MB 4	AB75 160 MB 4	AC70 160 MB 4	AC75 160 MB 4	11.00	23.00	0.70-7.00	45.70	14.60	1.60-7.90	51.50	16.50	4.90-9.80	63.70	20.40		5.90-10.30	38.40	12.30	9.00-15.70	58.70	32.70	1.00-9.90	64.30	20.60	11.00	71.50	22.90	4		
AB70 160 L 4	AB75 160 L 4	AC70 160 L 4	AC75 160 L 4	15.00	30.00	1.00-9.60	62.40	19.10	2.20-10.80	70.20	21.50	6.70-13.40	86.80	26.70		8.10-14.00	52.30	16.10	12.30-21.50	80.10	42.80	1.40-13.50	87.70	26.90	15.00	97.50	29.90	4		
AB70 180 M 4	AB75 180 M 4	AC70 180 M 4	AC75 180 M 4	18.50	39.00	1.20-11.80	77.00	25.00	2.70-13.30	87.00	28.20	8.20-16.50	107.00	34.90		9.90-17.30	65.00	21.00	15.20-26.50	99.00	55.90	1.70-16.70	108.00	35.20	18.50	120.20	39.10	4		
AB70 180 L 4	AB75 180 L 4	AC70 180 L 4	AC75 180 L 4	22.00	44.00	1.40-14.10	92.00	28.30	3.20-15.80	103.00	31.90	9.80-19.60	127.00	39.40		11.80-20.60	77.00	23.80	18.10-31.50	118.00	63.30	2.00-19.80	129.00	39.80	22.00	143.00	44.30	4		
AB70 200 LB 4	AB75 200 LB 4	AC70 200 LB 4	AC75 200 LB 4	30.00	54.00	1.90-19.20	124.00	34.30	4.30-21.60	140.00	38.60	13.40-26.70	173.00	47.80		16.10-28.00	104.00	28.80	24.70-42.90	160.00	76.60	2.70-27.00	175.00	48.30	30.00	194.00	53.60	4		
AB70 225 S 4	AB75 225 S 4	AC70 225 S 4	AC75 225 S 4	37.00	70.00	2.40-23.70	153.00	44.60	5.30-26.60	172.00	50.20	16.50-33.00	113.00	62.20		19.90-34.60	128.00	37.50	28.90-50.30	186.00	94.70	3.30-33.30	215.00	62.80	37.00	239.00	69.80	4		
AB70 225 M 4	AB75 225 M 4	AC70 225 M 4	AC75 225 M 4	45.00	82.00	2.90-28.80	186.00	52.70	6.50-32.40	209.00	59.30	20.00-40.10	259.00	73.40		24.20-42.00	156.00	44.20	35.10-61.10	227.00	111.90	4.10-40.50	261.00	74.10	45.00	290.00	82.40	4		
AB70 250 M 4	AB75 250 M 4	AC70 250 M 4	AC75 250 M 4	55.00	96.00	3.50-35.20	226.00	61.40	7.90-39.60	255.00	69.10	24.50-49.00	315.00	85.50		29.50-51.40	190.00	51.50	42.90-74.70	276.00	130.30	5.00-49.50	318.00	86.40	55.00	354.00	96.00	4		
AB70 280 S 4	AB75 280 S 4	AC70 280 S 4	AC75 280 S 4	75.00	136.00	4.80-48.00	310.00	86.60	10.50-52.50	339.00	94.70	32.20-64.50	416.00	116.40		33.70-58.70	218.00	60.90	58.60-101.90	378.00	183.80	6.60-66.00	426.00	119.10	75.00	484.00	135.40	4		
AB70 280 M 4	AB75 280 M 4	AC70 280 M 4	AC75 280 M 4	90.00	163.00	5.80-57.60	370.00	103.90	12.60-63.00	405.00	113.70	38.70-77.40	498.00	139.70		40.50-70.50	261.00	73.10	70.30-122.30	452.00	220.50	7.90-79.20	509.00	142.90	90.00	579.00	162.40	4		
AB70 315 S 4	AB75 315 S 4	AC70 315 S 4	AC75 315 S 4	110.00	199.00	7.00-70.40	453.00	127.20	15.40-77.00	495.00	139.10	47.30-94.60	608.00	170.90		49.50-86.10	318.00	89.40	85.90-149.40	552.00	269.80	9.70-96.80	623.00	174.80	110.00	707.00	198.70	4		
AB70 315 LA 4	AB75 315 LA 4	AC70 315 LA 4	AC75 315 LA 4	132.00	239.00	8.50-84.50	543.00	154.20	18.50-92.40	594.00	168.70	56.80-113.50	730.00	207.20		59.40-103.30	382.00	108.40	103.10-179.30	663.00	327.30	11.60-116.10	747.00	212.10	132.00	849.00	241.00	4		
AB70 315 LB 4	AB75 315 LB 4	AC70 315 LB 4	AC75 315 LB 4	160.00	282.00	10.20-102.40	657.00	179.90	22.40-112.00	719.00	196.80	68.80-137.60	883.00	241.80		72.00-125.30	462.00	126.50	124.90-217.40	802.00	381.80	14.10-140.80	904.00	247.40	160.00	1027.00	281.20	4		
AB70 315 LC 4	AB75 315 LC 4	AC70 315 LC 4	AC75 315 LC 4	200.00	354.00																									



GB	Motors energized by inverter	Self-ventilated IC 411	Self-ventilated IC 411 or forced ventilation IC 416	Forced ventilation IC 416	Self-ventilated IC 411	Pole	GB
F	Moteurs alimentés par variateur	Autoventilés IC 411	Autoventilés IC 411 ou ventilation assistée IC 416	Ventilation assistée IC 416	Autoventilés IC 411	Pôles	F
D	Motoren mit Umrichter-versorgung	Eigenbelüftet IC 411	Eigenbelüftet IC 411 oder fremdbelüftet IC 416	Fremdbelüftung IC 416	Eigenbelüftet IC 411	Pole	D
E	Motores alimentados con inverter	Autoventilados IC 411	Autoventilados IC 411 o ventilación asistida IC 416	Ventilación asistida IC 416	Autoventilados IC 411	Polos	E
I	Motori alimentati da inverter	Autoventilati IC 411	Autoventilati IC 411 o ventilazione assistita IC 416	Ventilazione assistita IC 416	Autoventilati IC 411	6 Poli	I

	400 V, 50 Hz	[Hz] 5 ÷ 50 range 1 ÷ 10 [1/min] 100 ÷ 1000	[Hz] 10 ÷ 50 range 1 ÷ 5 [1/min] 200 ÷ 1000	[Hz] 25 ÷ 50 range 1 ÷ 2 [1/min] 500 ÷ 1000	[Hz] 50 ÷ 87 range 10 ÷ 17 [1/min] 1000 ÷ 1750	[Hz] 50 ÷ 87 range 10 ÷ 17 [1/min] 1000 ÷ 1750	[Hz] 5 ÷ 50 range 1 ÷ 10 [1/min] 100 ÷ 1000	[Hz] 5 ÷ 50 range 1 ÷ 10 [1/min] 100 ÷ 1000	
Motor type	Mains connection	Constant torque	Constant torque	Constant torque	Constant torque - Weakened flux	Constant torque - Constant flux Δ connection	Constant torque - Forced Ventilation	Quadratic torque ●	Class T
Moteur type	Alimentation de secteur	Couple constant	Couple constant	Couple constant	Couple constant - Flux affaibli	Couple constant - Flux constant raccordement Δ	Couple constant - Ventilation Assistée	Couple quadratique ●	Classe T
Motor Typ	Netzspeisung	Konstantes Gegenmoment	Konstantes Gegenmoment	Konstantes Gegenmoment	Konstantes Gegenmoment - Feldschwächbetrieb	Konstantes Gegenmoment - konstanter Strom Δ-Verbindung	Konstantes Gegenmoment - Fremdbelüftung	Quadratisches Gegenmoment ●	Klasse T
Tipo de motor	Alimentación desde la red	Par constante	Par constante	Par constante	Par constante - Flujo debilitado	Par constante - Flujo constante conexión Δ	Par constante - Ventilación asistida	Par cuadrático ●	Clase T
Tipo motore	Alimentazione da rete	Coppia costante	Coppia costante	Coppia costante	Coppia costante - Flusso indebolito	Coppia costante - Flusso costante collegamento Δ	Coppia costante - Ventilazione Assistita	Coppia quadratica ●	Classe T

IIB		IIC		P <sub>n</sub> [kW]	I <sub>n</sub> [A]	P [kW]	M [Nm]	I [A]	P [kW]	M [Nm]	I [A]	P [kW]	M [Nm]	I [A]	P [kW]	M [Nm]	I [A]	P [kW]	M [Nm]	I [A]	P [kW]	M [Nm]	I [A]	◀ ◆				
Ex d	Ex de	Ex d	Ex de																									
AB70 63 B 6	AB75 63 B 6	AC70 63 B 6	AC75 63 B 6	0.09	0.65	0.01-0.06	0.65	0.42	0.01-0.06	0.73	0.47	0.04-0.08	0.90	0.59		0.05-0.08	0.54	0.35	0.07-0.13	0.83	0.94	---	---	---	0.09	1.01	0.66	4
AB70 71 A 6	AB75 71 A 6	AC70 71 A 6	AC75 71 A 6	0.18	0.92	0.01-0.12	1.18	0.70	0.03-0.13	1.33	0.79	0.08-0.16	1.65	0.97		0.10-0.17	0.99	0.59	0.15-0.26	1.52	1.56	---	---	---	0.18	1.85	1.09	4
AB70 71 B 6	AB75 71 B 6	AC70 71 B 6	AC75 71 B 6	0.26	1.00	0.02-0.17	1.73	0.64	0.04-0.19	1.95	0.71	0.12-0.23	2.41	0.88		0.14-0.24	1.45	0.53	0.21-0.37	2.22	1.42	---	---	---	0.26	2.70	0.99	4
AB70 80 A 6	AB75 80 A 6	AC70 80 A 6	AC75 80 A 6	0.37	1.60	0.02-0.24	2.43	1.02	0.05-0.27	2.74	1.14	0.16-0.33	3.39	1.41		0.20-0.35	2.04	0.85	0.30-0.53	3.12	2.27	---	---	---	0.37	3.80	1.59	4
AB70 80 B 6	AB75 80 B 6	AC70 80 B 6	AC75 80 B 6	0.55	1.80	0.04-0.35	3.61	1.12	0.08-0.40	4.07	1.26	0.24-0.49	5.03	1.55		0.30-0.51	3.03	0.94	0.45-0.79	4.64	2.49	---	---	---	0.55	5.65	1.74	4
AB70 90 S 6	AB75 90 S 6	AC70 90 S 6	AC75 90 S 6	0.75	2.20	0.05-0.48	5.04	1.39	0.11-0.54	5.67	1.57	0.33-0.67	7.01	1.94		0.40-0.70	4.23	1.17	0.62-1.07	6.47	3.11	---	---	---	0.75	7.87	2.18	4
AB70 90 L 6	AB75 90 L 6	AC70 90 L 6	AC75 90 L 6	1.10	3.20	0.07-0.70	7.19	2.00	0.16-0.79	8.09	2.25	0.49-0.98	10.01	2.79		0.59-1.03	6.03	1.68	0.90-1.57	9.24	4.47	---	---	---	1.10	11.24	3.13	4
AB70 100 LB 6	AB75 100 LB 6	AC70 100 LB 6	AC75 100 LB 6	1.50	3.80	0.10-0.96	9.65	2.43	0.22-1.07	10.86	2.73	0.67-1.34	13.44	3.38		0.81-1.40	8.10	2.04	1.23-2.14	12.39	5.43	0.13-1.35	13.57	3.42	1.50	15.08	3.80	4
AB70 112 M 6	AB75 112 M 6	AC70 112 M 6	AC75 112 M 6	2.20	6.20	0.10-1.40	14.00	3.90	0.30-1.60	15.80	4.40	1.00-2.00	19.50	5.40		1.20-2.10	11.80	3.30	1.80-3.20	18.00	8.70	0.20-2.00	19.70	5.50	2.20	21.90	6.10	4
AB70 132 S 6	AB75 132 S 6	AC70 132 S 6	AC75 132 S 6	3.00	8.50	0.20-1.90	19.30	5.40	0.40-2.20	21.70	6.10	1.30-2.70	26.90	7.60		1.60-2.80	16.20	4.60	2.50-4.30	24.80	12.10	0.30-2.70	27.20	7.60	3.00	30.20	8.50	4
AB70 132 M 6	AB75 132 M 6	AC70 132 M 6	AC75 132 M 6	4.00	9.50	0.30-2.60	25.20	6.10	0.60-2.90	28.40	6.80	1.80-3.60	35.10	8.50		2.20-3.70	21.20	5.10	3.30-5.70	32.40	13.60	0.40-3.60	35.40	8.60	4.00	39.40	9.50	4
AB70 132 ML 6	AB75 132 ML 6	AC70 132 ML 6	AC75 132 ML 6	5.50	12.00	0.40-3.50	35.00	7.70	0.80-4.00	39.40	8.60	2.50-4.90	48.80	10.70		3.00-5.10	29.40	6.40	4.50-7.90	45.00	17.10	0.50-5.00	49.20	10.80	5.50	54.70	12.00	4
AB70 160 MB 6	AB75 160 MB 6	AC70 160 MB 6	AC75 160 MB 6	7.50	16.00	0.50-4.80	48.30	10.20	1.10-5.40	54.30	11.50	3.30-6.70	67.20	14.20		4.00-7.00	40.50	8.50	6.20-10.70	62.00	22.70	0.70-6.80	67.90	14.30	7.50	75.40	15.90	4
AB70 160 L 6	AB75 160 L 6	AC70 160 L 6	AC75 160 L 6	11.00	23.00	0.70-7.00	70.80	14.80	1.60-7.90	79.60	16.60	4.90-9.80	98.50	20.50		5.90-10.30	59.40	12.40	9.00-15.70	91.00	33.00	1.00-9.90	99.50	20.80	11.00	110.60	23.10	4
AB70 180 L 6	AB75 180 L 6	AC70 180 L 6	AC75 180 L 6	15.00	29.00	1.00-9.60	96.00	18.30	2.20-10.80	107.00	20.60	6.70-13.40	133.00	25.50		8.10-14.00	80.00	15.40	12.30-21.50	123.00	40.90	1.40-13.50	134.00	25.70	15.00	149.00	28.60	4
AB70 200 LA 6	AB75 200 LA 6	AC70 200 LA 6	AC75 200 LA 6	18.50	38.00	1.20-11.80	116.00	24.40	2.70-13.30	130.00	27.40	8.20-16.50	161.00	34.00		9.90-17.30	97.00	20.50	15.20-26.50	149.00	54.50	1.70-16.70	163.00	34.30	18.50	181.00	38.10	4
AB70 200 LB 6	AB75 200 LB 6	AC70 200 LB 6	AC75 200 LB 6	22.00	44.00	1.40-14.10	137.00	28.30	3.20-15.80	154.00	31.90	9.80-19.60	191.00	39.40		11.80-20.60	115.00	23.80	18.10-31.50	176.00	63.30	2.00-18.80	193.00	39.80	22.00	214.00	44.30	4
AB70 225 M 6	AB75 225 M 6	AC70 225 M 6	AC75 225 M 6	30.00	61.00	1.90-19.20	186.00	38.60	4.30-21.60	209.00	43.40	13.40-26.70	259.00	53.80		16.10-28.00	156.00	32.40	23.40-40.80	227.00	81.90	2.70-27.00	262.00	54.30	30.00	291.00	60.30	4
AB70 250 M 6	AB75 250 M 6	AC70 250 M 6	AC75 250 M 6	37.00	72.00	2.40-23.70	228.00	46.00	5.30-26.60	257.00	51.80	16.50-33.00	318.00	64.10		19.90-34.60	192.00	38.60	28.90-50.30	279.00	97.70	3.30-33.30	321.00	64.70	37.00	357.00	71.90	4
AB70 280 S 6	AB75 280 S 6	AC70 280 S 6	AC75 280 S 6	45.00	90.50	2.90-28.80	280.00	58.40	6.30-31.50	306.00	63.80	19.40-38.70	376.00	78.40		20.30-35.20	197.00	41.00	35.10-61.10	342.00	123.90	4.00-39.60	385.00	80.30	45.00	438.00	91.20	4
AB70 280 M 6	AB75 280 M 6	AC70 280 M 6	AC75 280 M 6	55.00	109.00	3.50-35.20	343.00	68.90	7.70-38.50	375.00	75.40	23.70-47.30	461.00	92.60		24.70-43.10	241.00	48.50	43.00-74.70	419.00	146.20	4.80-48.40	472.00	94.80	55.00	536.00	107.70	4
AB70 315 S 6	AB75 315 S 6	AC70 315 S 6	AC75 315 S 6	75.00	147.20	4.80-48.00	463.00	93.30	10.50-52.50	506.00	102.00	32.20-64.50	622.00	125.30		33.70-58.70	326.00	65.60	58.60-101.90	565.00	197.90	6.60-66.00	637.00	128.30	75.00	724.00	145.80	4
AB70 315 LA 6	AB75 315 LA 6	AC70 315 LA 6	AC75 315 LA 6	90.00	167.60	5.80-57.60	558.00	111.90	12.60-63.00	611.00	122.40	38.70-77.40	750.00	150.40		40.50-70.50	393.00	78.70	70.30-122.30	681.00	237.50	7.90-79.20	768.00	153.90	90.00	873.00	174.90	4
AB70 315 LB 6	AB75 315 LB 6	AC70 315 LB 6	AC75 315 LB 6	110.00	205.00	7.00-70.40	676.00	130.20	15.40-77.00	740.00	142.40	47.30-94.60	909.00	175.00		49.50-86.10	476.00	91.60	85.90-149.40	825.00	276.30	9.70-96.80	930.00	179.00	110.00	1057.00	203.50	4
AB70 315 LC 6	AB75 315 LC 6	AC70 315 LC 6	AC75 315 LC 6	132.00	243.00	8.50-84.50	811.00	156.30	18.50-92.40	887.00	170.90	56.80-113.50	1090.00	210.00		59.40-103.30	570.00	109.90	103.10-179.30	989.00	331.60	11.60-116.10	1115.00	214.90	132.00	1267.00	244.20	4

Rounded values  
Valeurs arrondies  
Gerundete Werte  
Valores redondeado  
Valori arrotondati

● Values refer to 50 Hz  
Valeurs se réfèrent à 50 Hz  
Werte beziehen sich auf 50 Hz  
Valores se refieren a 50 Hz  
Valori riferiti a 50 Hz

◀ Same certificates as section 4.1  
Mêmes certificats que ceux de la section 4.1  
Gleiche Bescheinigungen wie in Abschnitt 4.1  
Los mismos certificados que en la sección 4.1  
Stessi certificati della sezione 4.1

◆ T3 upon request;  
T3 sur demande;  
T3 auf Wunsch;  
T3 según demanda;  
T3 a richiesta;



## 2 pole - pôles - polig - polos - poli

frame size - hauteur d'axe - Baugröße - tamaño - altezza d'asse

63 ÷ 100

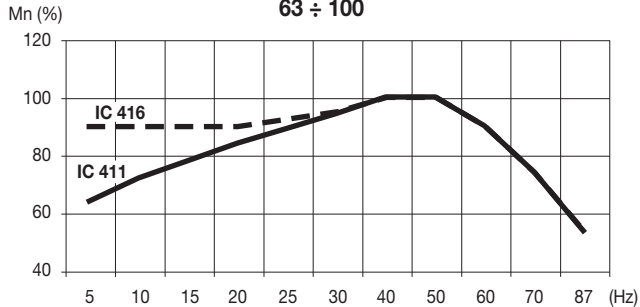

frame size - hauteur d'axe - Baugröße - tamaño - altezza d'asse

112 ÷ 160

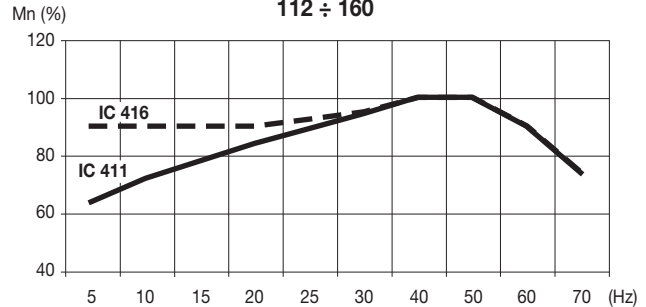

frame size - hauteur d'axe - Baugröße - tamaño - altezza d'asse

180 ÷ 250

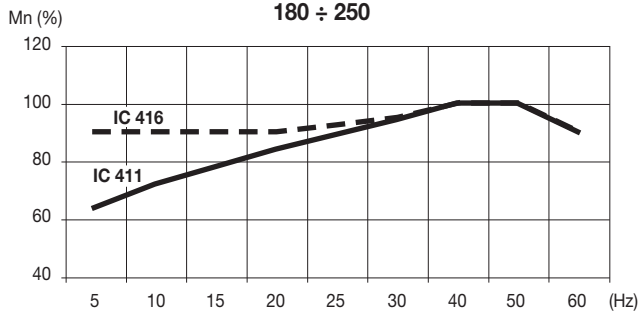

frame size - hauteur d'axe - Baugröße - tamaño - altezza d'asse

280 ÷ 315

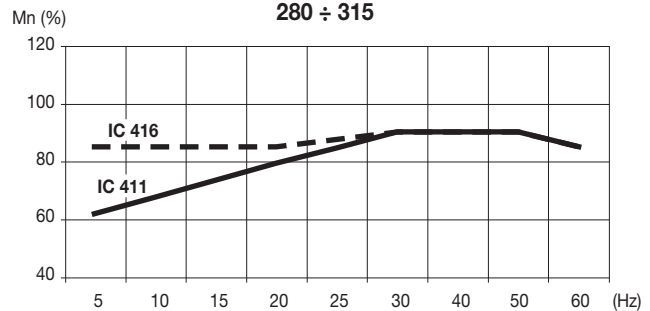

## 4 - 6 - 8 pole - pôles - polig - polos - poli

frame size - hauteur d'axe - Baugröße - tamaño - altezza d'asse

63 ÷ 250

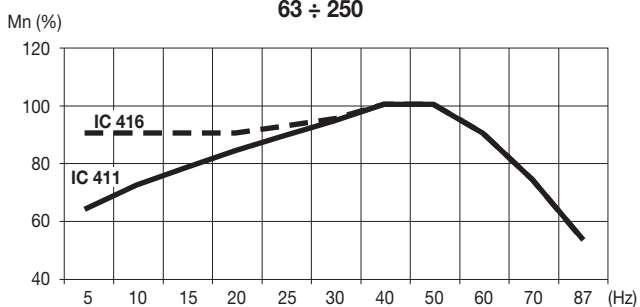

frame size - hauteur d'axe - Baugröße - tamaño - altezza d'asse

280 ÷ 315

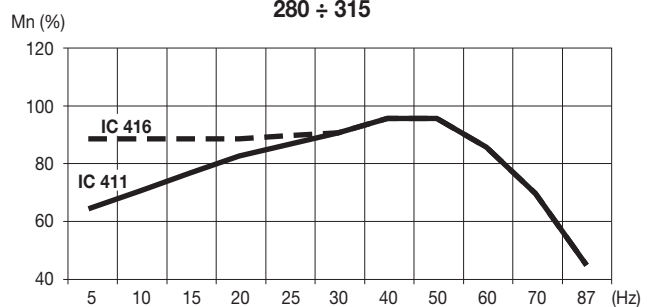

Mn (%)  
Torque  
Couple  
Gegenmoment  
Par  
Coppia

(Hz)  
Frequency  
Fréquence  
Frequenz  
Frequencia  
Frequenza

IC 411  
Self-ventilated  
Autoventilés  
Eigenbelüftet  
Autoventilados  
Autoventilati

IC 416  
Forced ventilation (available from frame size 100)  
Ventilation assistée (disponible à partir de hauteur d'axe 100)  
Fremdbelüftung (verfügbar ab Baugröße 100)  
Ventilacion asistida (disponible a partir de altura del eje 100)  
Ventilazione assistita (disponibile da altezza d'asse 100)

## 2 pole - pôles - polig - polos - poli

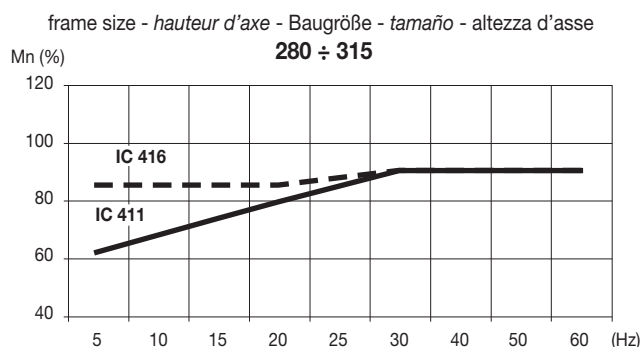
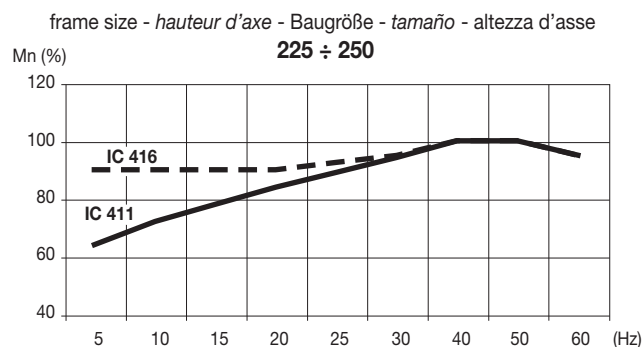
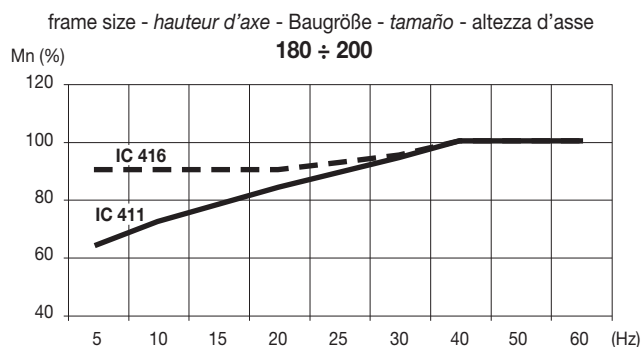
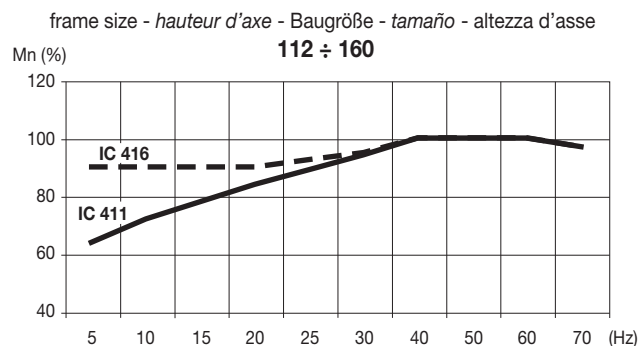
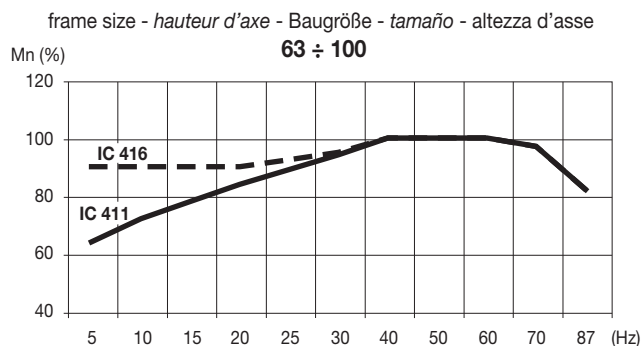

## Note:

In the constant torque operating mode, the usable torque value is the lowest value of the chosen range of operation

Lors du fonctionnement à couple constant la valeur de couple utilisable est la valeur inférieure à la plage de fonctionnement sélectionnée

Im Betrieb mit konstantem Drehmoment ist der verwendbare Momentwert der Mindestwert des gewählten Betriebsbereichs

En el funcionamiento con par constante el valor de par que se puede utilizar es el valor menor del intervalo de funcionamiento elegido

Nel funzionamento a coppia costante il valore di coppia utilizzabile è il valore minore del range di funzionamento prescelto

The reference torque value (Mn) is the value indicated in the tables in section 4.1

La valeur de couple de référence (Mn) est celle indiquée dans les tableaux de la section 4.1

Der Richtwert des Drehmoments (Mn) ist der in den Tabellen in Abschnitt 4.1 angegebene

El valor de par de referencia (Mn) es el que recogen las tablas de la sección 4.1

Il valore di coppia di riferimento (Mn) è quello indicato nelle tabelle della sezione 4.1

## 4 - 6 - 8 pole - pôles - polig - polos - poli

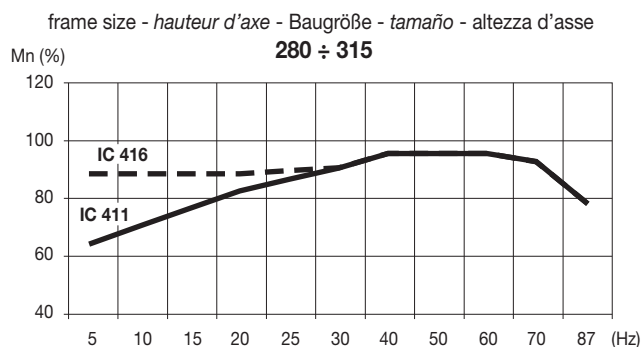
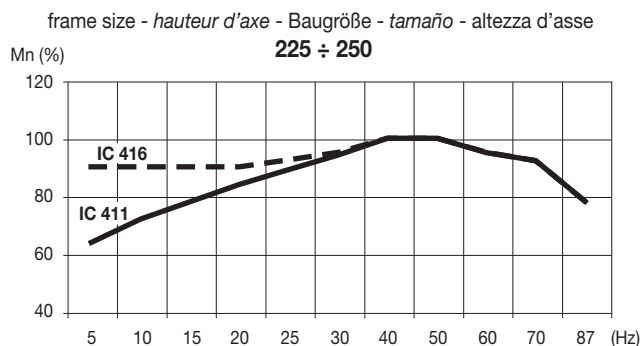
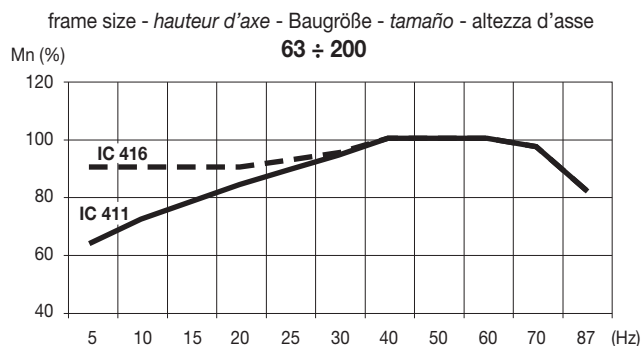

Motors energized by inverter - Load capacity curves

Quadratic torque

Moteurs alimentés par variateur - Courbes de chargeabilité

Couple quadratique

Motoren mit Umrichterversorgung - Belastungskurven

Quadratisches Gegenmoment

Motores alimentados con inverter - Curvas de capacidad de carga

Par cuadrático

Motori alimentati da inverter - Curve di caricabilità

Coppia quadratica

## 2 - 4 - 6 - 8 pole - pôles - polig - polos - poli

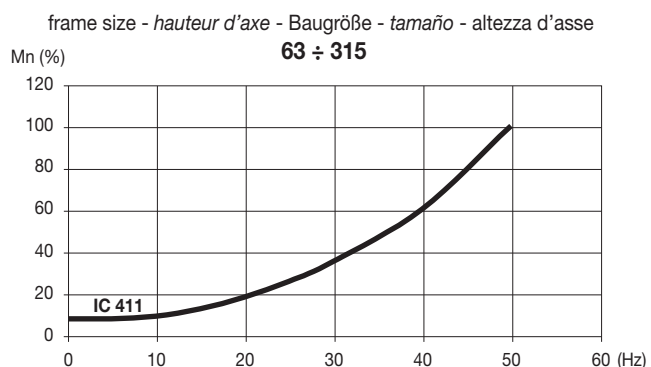

Note:

see page 242, 243;  
voir page 242, 243;  
siehe Seite 242, 243;  
véase página 242, 243;  
vedi pagina 242, 243;



## 5. Overall dimensions

### 5. *Dimensions*

### 5. Abmessungen

### 5. *Dimensiones de espacio máximo*

### 5. Dimensioni d'ingombro

IM B3

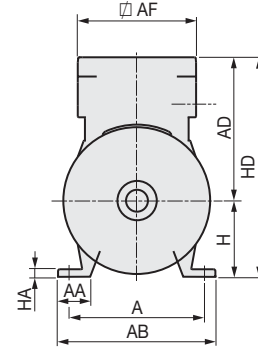
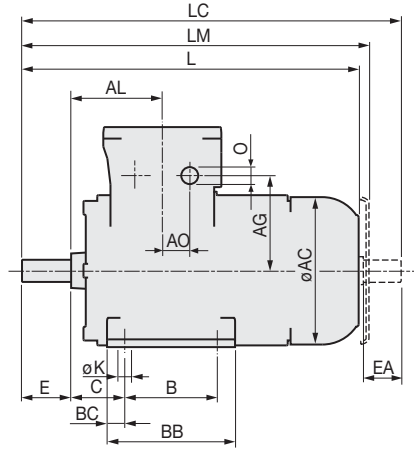

IM B5

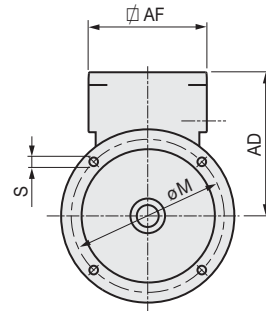
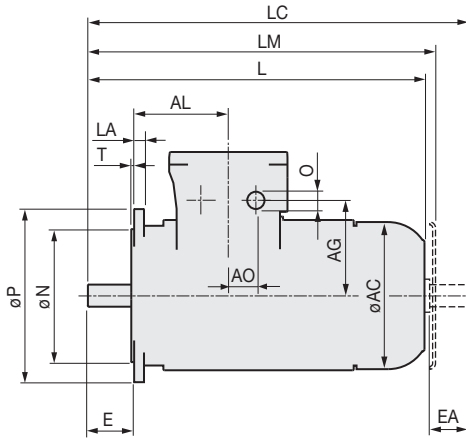

IM B35

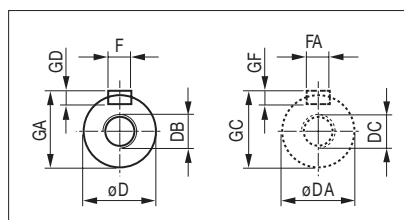
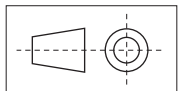
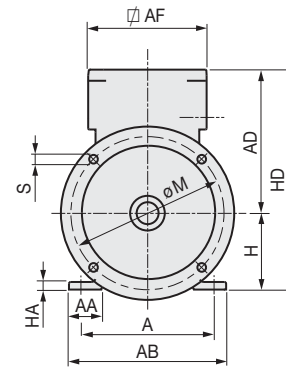
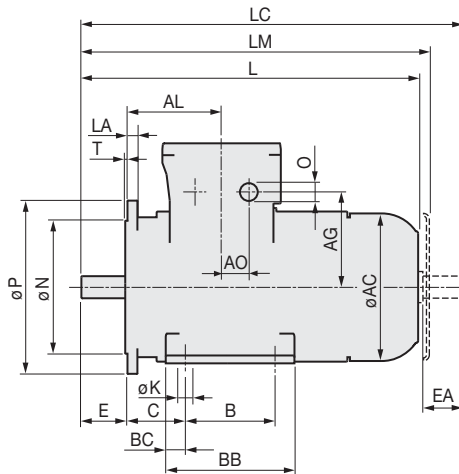

225÷315

- ◆ 8 holes
- 8 trous
- 8 Bohrungen
- 8 orificios
- 8 fori

## Overall dimensions [mm]

GB

## Dimensions [mm]

F

## Abmessungen [mm]

D

## Dimensiones [mm]

E

## Dimensioni d'ingombro [mm]

I

Type	A	AA	AB	ø AC	AD	AF	AL	B	BC	BB	C	H <sub>0.5</sub>	HA	HD	ø K	L	LC
63	100	25	125	123	144	139	93	80	12	105	40	63	6	207	7	245	278
71	112	32	140	140	154	139	106	90	11	112	45	71	7	225	7	276	316
80	125	37	160	158	165	139	142	100	15	130	50	80	8	245	9	330	380
90 S	140	45	175	178	174	139	124	100	12	157	56	90	9	264	9	386	446
90 L	140	45	175	178	174	139	124	125	12	157	56	90	9	264	9	386	446
100	160	45	200	196	185	139	125	140	15	170	63	100	10	285	12	426	496
112	190	45	235	223	206	139	138	140	17	175	70	112	12	318	12	475	545
132 S	216	56	272	258	293	205	163	140	22	222	89	132	13	398	12	508	598
132 M-L	216	56	272	258	293	205	163	178	22	222	89	132	13	398	12	583	673
160 M	254	64	318	310	293	205	165	210	25	305	108	160	15	453	14	685	805
160 L	254	64	318	310	293	205	165	254	25	305	108	160	15	453	14	685	805
180 M	279	71	350	360	326	228	225	241	25	340	121	180	17	506	14	815	925
180 L	279	71	350	360	326	228	225	279	25	340	121	180	17	506	14	815	925
200	318	75	393	395	346	228	230	305	27	360	133	200	18	546	18	870	990
225 S	356	78	431	445	371	228	240	286	38	380	149	225	20	596	18	945	1090
225 M 2	356	78	431	445	371	228	240	311	38	380	149	225	20	596	18	915	1030
225 M 4-8	356	78	431	445	371	228	240	311	38	380	149	225	20	596	18	945	1090
250 M 2	406	95	500	490	395	228	221	349	33	415	168	250	22	645	24	975	1125
250 M 4-8	406	95	500	490	395	228	221	349	33	415	168	250	22	645	24	975	1050
280 S 2	457	90	540	558	543	320	316	368	30	480	190	280	41	817	22	1120	1270
280 S 4-8	457	90	540	558	543	320	316	368	30	480	190	280	41	817	22	1120	1270
280 M 2	457	90	540	558	543	320	316	419	30	480	190	280	41	817	22	1120	1270
280 M 4-8	457	90	540	558	543	320	316	419	30	480	190	280	41	817	22	1120	1270
315 S 2	508	110	590	558	543	320	316	406	32	470	216	315	41	852	27	1270	1420
315 S 4-8	508	110	590	558	543	320	316	406	32	470	216	315	41	852	27	1300	1480
315 M 2	508	110	590	558	543	320	316	457	32	520	216	315	41	852	27	1270	1420
315 M 4-8	508	110	590	558	543	320	316	457	32	520	216	315	41	852	27	1300	1480
315 L 2	508	100	590	626	590	320	330	457	32	520	216	315	41	905	28	1450	1600
315 L 4-8	508	100	590	626	590	320	330	457	32	520	216	315	41	905	28	1480	1660

Type	* LM	AO	IEC 423 n. x O	AG	ø D ø DA	E EA	F FA	GA GC	GD GF	DB DC	LA	ø M	ø N	ø P	◆ S	T
63	267	24	1 x M25	87	11j6	23	4	12.5	4	M4	8	115	95j6	140	10	3
71	303	24	1 x M25	96	14j6	30	5	16	5	M5	10	130	110j6	160	10	3.5
80	357	24	1 x M25	107	19j6	40	6	21.5	6	M6	11	165	130j6	200	12	3.5
90 S	413	24	1 x M25	116	24j6	50	8	27	7	M8	11	165	130j6	200	12	3.5
90 L	413	24	1 x M25	116	24j6	50	8	27	7	M8	11	165	130j6	200	12	3.5
100	456	24	1 x M25	126	28j6	60	8	31	7	M10	14	215	180j6	250	15	4
112	512	35	1 x M25	160	28j6	60	8	31	7	M10	16	215	180j6	250	15	4
132 S	557	35	2 x M32	164	38k6	80	10	41	8	M12	17	265	230j6	300	15	4
132 M-L	632	35	2 x M32	164	38k6	80	10	41	8	M12	17	265	230j6	300	15	4
160 M	730	35	2 x M32	207	42k6	110	12	45	8	M16	18	300	250h6	350	18	5
160 L	730	35	2 x M32	207	42k6	110	12	45	8	M16	18	300	250h6	350	18	5
180 M	860	40	2 x M40	266	48k6	110	14	52	9	M16	20	300	250h6	350	18	5
180 L	860	40	2 x M40	266	48k6	110	14	52	9	M16	20	300	250h6	350	18	5
200	915	40	2 x M40	286	55m6	110	16	59	10	M20	20	350	300h6	400	18	5
225 S	990	40	2 x M40	311	60m6	140	18	64	11	M20	22	400	350h6	450	18	5
225 M 2	960	40	2 x M40	311	55m6	110	16	59	10	M20	22	400	350h6	450	18	5
225 M 4-8	990	40	2 x M40	311	60m6	140	18	64	11	M20	22	400	350h6	450	18	5
250 M 2	1020	40	2 x M40	338	60m6	140	18	64	11	M20	18	500	450h6	550	18	5
250 M 4-8	1020	40	2 x M40	338	65m6	140	18	69	11	M20	18	500	450h6	550	18	5
280 S 2	1215	56	2 x M63	409	65m6	140	18	69	11	M20	18	500	450h6	550	18	5
280 S 4-8	1215	56	2 x M63	409	75m6	140	20	79.5	12	M20	18	500	450h6	550	18	5
280 M 2	1215	56	2 x M63	409	65m6	140	18	69	11	M20	18	500	450h6	550	18	5
280 M 4-8	1215	56	2 x M63	409	75m6	140	20	79.5	12	M20	18	500	450h6	550	18	5
315 S 2	1365	56	2 x M63	409	65m6	140	18	69	11	M20	22	600	550h6	660	22	6
315 S 4-8	1405	56	2 x M63	409	80m6	170	22	85	14	M20	22	600	550h6	660	22	6
315 M 2	1365	56	2 x M63	409	65m6	140	18	69	11	M20	22	600	550h6	660	22	6
315 M 4-8	1405	56	2 x M63	409	80m6	170	22	85	14	M20	22	600	550h6	660	22	6
315 L 2	1545	56	2 x M63	449	65m6	140	18	69	11	M20	22	600	550h6	660	24	6
315 L 4-8	1575	56	2 x M63	449	80m6	170	22	85	14	M20	22	600	550h6	660	24	6

◆ see page 246; voir page 246; siehe Seite 246; véase página 246; vedi pagina 246; \* see page 249; voir page 249; siehe Seite 249; véase página 249; vedi pagina 249;

⊥ see page 249; voir page 249; siehe Seite 249; véase página 249; vedi pagina 249;

GB  
F  
D  
E  
I

Overall dimensions [mm]

Dimensions [mm]

Abmessungen [mm]

Dimensiones [mm]

5. Dimensioni d'ingombro [mm]

63÷160

IM B14

IM B34

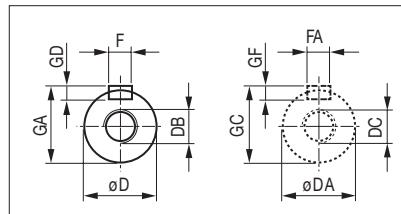
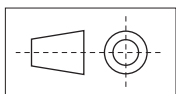
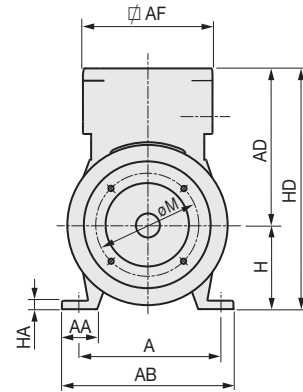
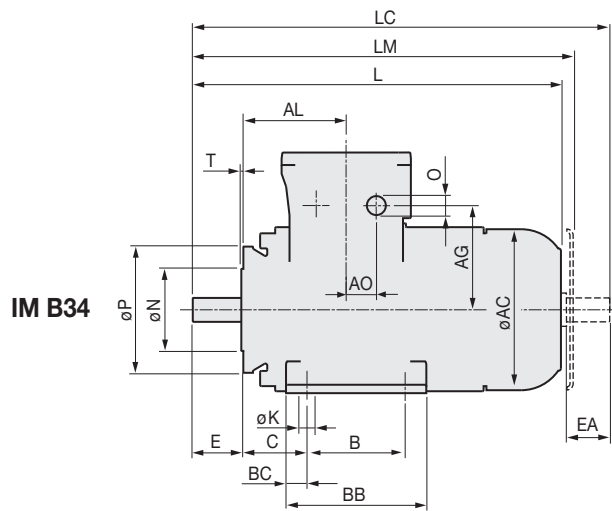
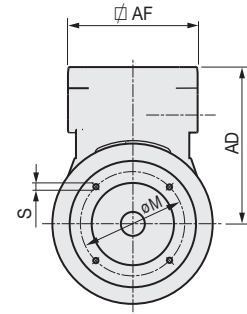
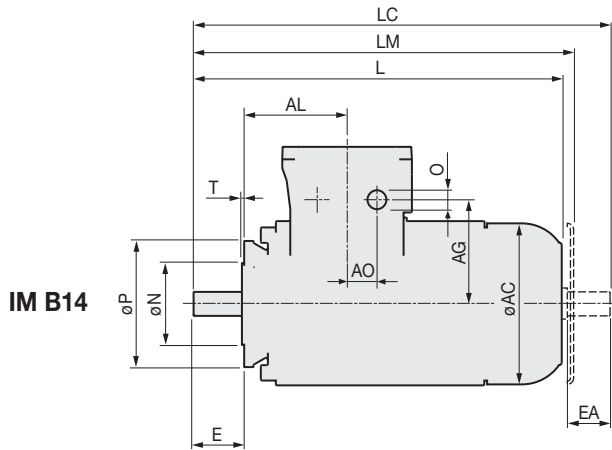

## Overall dimensions [mm]

GB

## Dimensions [mm]

F

## Abmessungen [mm]

D

## Dimensiones [mm]

E

## Dimensioni d'ingombro [mm]

I

Type	A	AA	AB	∅ AC	AD	∮ AF	AL	B	BC	BB	C	H <sub>0.5</sub> <sup>0</sup>	HA	HD	∅ K	L	LC
63	100	25	125	123	144	139	93	80	12	105	40	63	6	207	7	245	278
71	112	32	140	140	154	139	106	90	11	112	45	71	7	225	7	276	316
80	125	37	160	158	165	139	142	100	15	130	50	80	8	245	9	330	380
90 S	140	45	175	178	174	139	124	100	12	157	56	90	9	264	9	386	446
90 L	140	45	175	178	174	139	124	125	12	157	56	90	9	264	9	386	446
100	160	45	200	196	185	139	125	140	15	170	63	100	10	285	12	426	496
112	190	45	235	223	206	139	138	140	17	175	70	112	12	318	12	475	545
132 S	216	56	272	258	266	205	163	140	22	222	89	132	13	398	12	508	598
132 M-L	216	56	272	258	266	205	163	178	22	222	89	132	13	398	12	583	673
160 M	254	64	318	310	293	205	165	210	25	305	108	160	15	453	14	685	805
160 L	254	64	318	310	293	205	165	254	25	305	108	160	15	453	14	685	805

Type	* LM	AO	IEC 423 n. x O	AG	∅ D ∅ DA	E EA	F FA	GA GC	GD GF	DB DC	∅ M	∅ N	∅ P	S	T
63	262	24	1 x M25	87	11j6	23	4	12.5	4	M4	75	60j6	90	M5	2.5
71	303	24	1 x M25	96	14j6	30	5	16	5	M5	85	70j6	105	M6	2.5
80	357	24	1 x M25	107	19j6	40	6	21.5	6	M6	100	80j6	120	M6	3
90 S	413	24	1 x M25	116	24j6	50	8	27	7	M8	115	95j6	140	M8	3
90 L	413	24	1 x M25	116	24j6	50	8	27	7	M8	115	95j6	140	M8	3
100	456	24	1 x M25	126	28j6	60	8	31	7	M10	130	110j6	160	M8	3.5
112	512	35	1 x M25	160	28j6	60	8	31	7	M10	130	110j6	160	M8	3.5
132 S	557	35	2 x M32	164	38k6	80	10	41	8	M12	165	130j6	200	M10	3.5
132 M-L	632	35	2 x M32	164	38k6	80	10	41	8	M12	165	130j6	200	M10	3.5
160 M	730	35	2 x M32	207	42k6	110	12	45	8	M16	215	180h6	250	M12	4
160 L	730	35	2 x M32	207	42k6	110	12	45	8	M16	215	180h6	250	M12	4

\*

rain canopy: only when vertical shaft-down mounting

parapluie: uniquement pour position verticale, arbre vers le bas

Regenschutzdach: nur für die Vertikalbauformen

tapa de protección contra la lluvia: sólo para montaje en vertical, eje en la parte inferior

parapioggia: normalmente presente solo per montaggio verticale, albero in basso



1 in the terminal box, 1 on the frame

1 à l'intérieur de la boîte à bornes, 1 sur la carcasse

1 am Klemmkasten, 1 am Motorgehäuse

1 en la caja de bornes, 1 en la carcasa

1 nella scatola morsetti, 1 sulla carcassa

Tolerances allowed

Dimensions données à titre indicatif

Übliche Toleranzen

Cotas no vinculantes

Quote non impegnative

**6. Spare parts**

**6. *Pièces détachées***

**6. Ersatzteilliste**

**6. *Piezas de repuesto***

**6. Parti di ricambio**

6. Parti di ricambio

63 ÷ 132

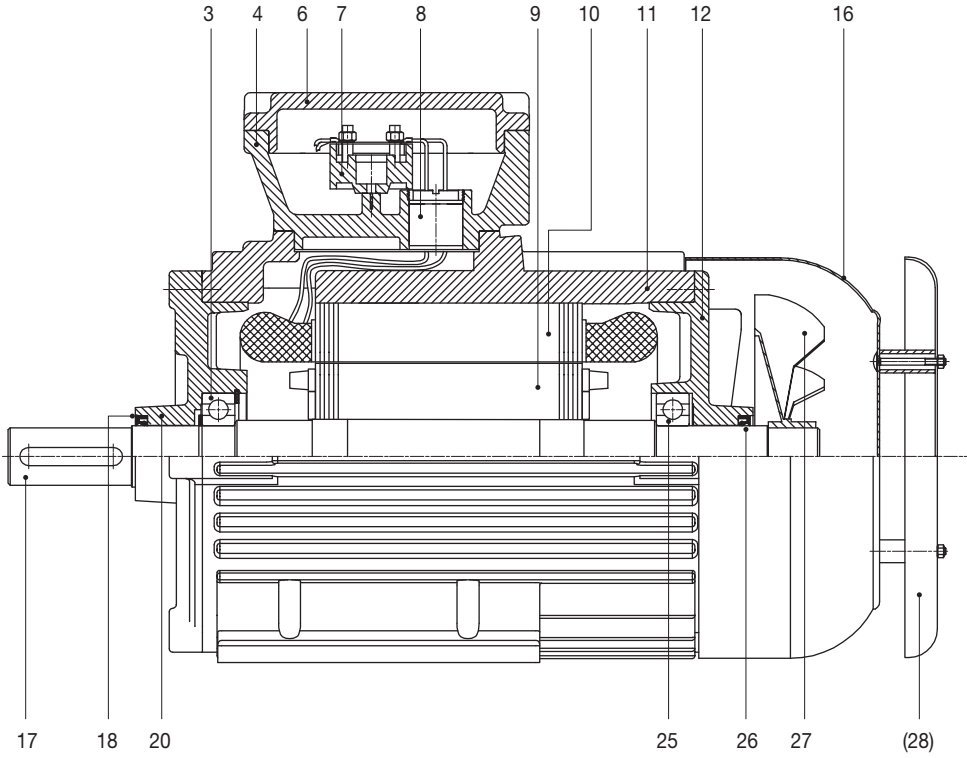

160

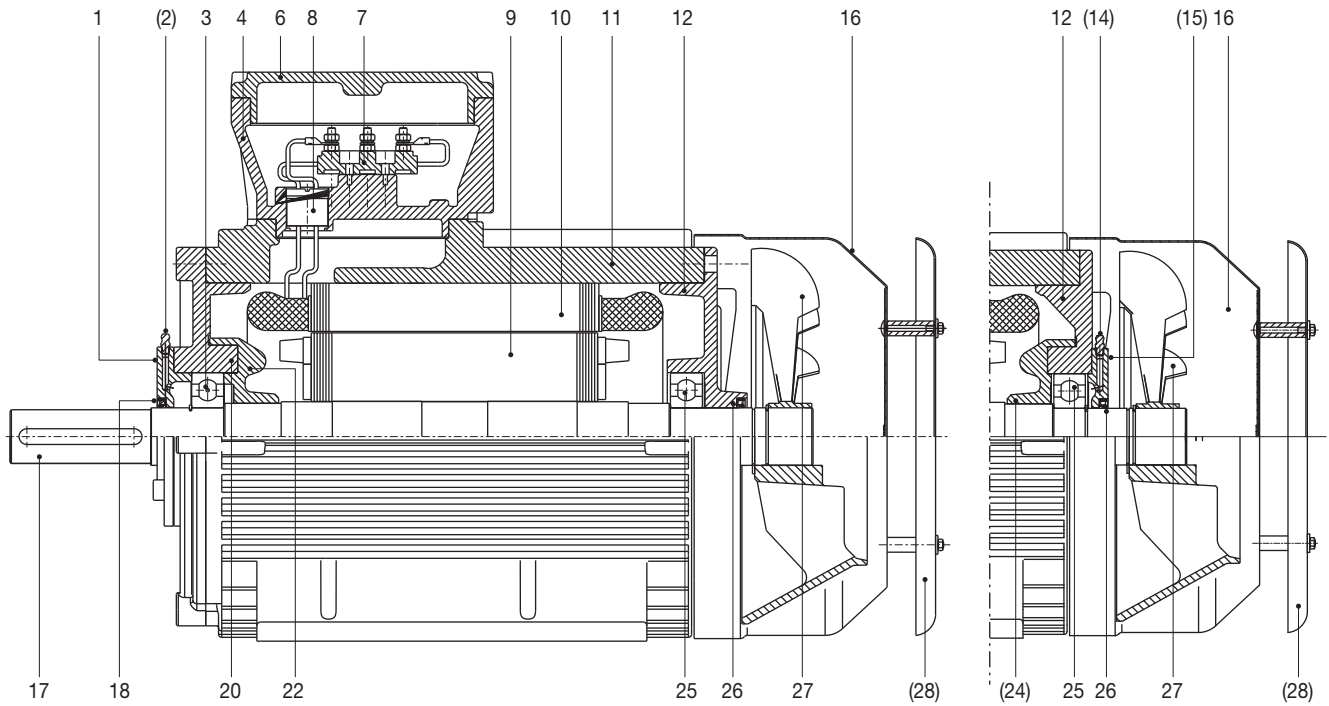

## GB

1 End cap - front	10 Stator	20 Endshield - front
(2) Grease nipple - front	11 Frame	22 Inner bearing cap - front
3 Front bearing	12 Endshield - rear	25 Rear bearing
4 Terminal box	(14) Grease nipple - rear	(24) Inner bearing cap - rear
6 Terminal box lid	(15) End cap - rear	26 Sealing ring - rear
7 Terminal board	16 Fan cover (cowl)	27 Cooling fan
8 Cable nipple	17 Shaft	(28) Rain cap
9 Rotor	18 Sealing ring - front	(...) = when provided

## F

1 Couvercle avant	10 Stator	20 Flasque avant
(2) Graisseur avant	11 Carcasse	22 Flasque intérieur avant
3 Roulement avant	12 Flasque arrière	25 Roulement arrière
4 Boîte à bornes	(14) Graisseur arrière	(24) Flasque intérieur arrière
6 Couvercle boîte à bornes	(15) Couvercle arrière	26 Bague arrière d'étanchéité
7 Bornes	16 Capot de ventilateur	27 Ventilateur
8 Dispositif pour le passage des câbles	17 Arbre	(28) Tôle parapluie
9 Rotor	18 Bague avant d'étanchéité	(...) = si prévu

## D

1 Äußerer Fettkammerdeckel A-Seite	10 Statorpaket	20 Lagerschild A-Seite
(2) Schmiernippel A-Seite	11 Motorgehäuse	22 Innerer Fettkammerdeckel A-Seite
3 Kugellager A-Seite	12 Lagerschild B-Seite	25 Kugellager B-Seite
4 Klemmkasten	(14) Schmiernippel B-Seite	(24) Innerer Fettkammerdeckel B-Seite
6 Klemmkastendeckel	(15) Äußerer Fettkammerdeckel B-Seite	26 Dichtungsring B-Seite
7 Klemmbrett	16 Lüfterhaube	27 Lüfterflügel
8 Druckfeste Kabeldurchführung	17 Welle	(28) Regenschutzdach
9 Läufer	18 Dichtungsring A-Seite	(...) = wenn vorgesehen

## E

1 Tapa externa delantera	10 Estator	20 Escudo delantero
(2) Engrasador delantero	11 Armazón	22 Fondo interno delantero
3 Cojinete delantero	12 Escudo trasero	25 Cojinete trasero
4 Caja de bornes	(14) Engrasador trasero	(24) Tapa interna trasera
6 Tapa de la caja de bornes	(15) Fondo externo trasero	26 Anillo de retención trasero
7 Placa de bornes	16 Casquete cobre ventilador	27 Ventilador
8 Niple paso cables	17 Eje	(28) Tapa de protección contra la lluvia
9 Rotor	18 Anillo de retención delantero	(...) = cuando previsto

## I

1 Fondello esterno anteriore	10 Statore	20 Scudo anteriore
(2) Ingrassatore anteriore	11 Carcassa	22 Fondello interno anteriore
3 Cuscinetto anteriore	12 Scudo posteriore	25 Cuscinetto posteriore
4 Scatola morsetti	(14) Ingrassatore posteriore	(24) Fondello interno posteriore
6 Coperchio scatola morsetti	(15) Fondello esterno posteriore	26 Anello di tenuta posteriore
7 Morsettiera	16 Calotta copriventola	27 Ventola
8 Niplo passaggio cavi	17 Albero	(28) Tettuccio parapioggia
9 Rotore	18 Anello di tenuta anteriore	(...) = quando previsto



180 ÷ 250

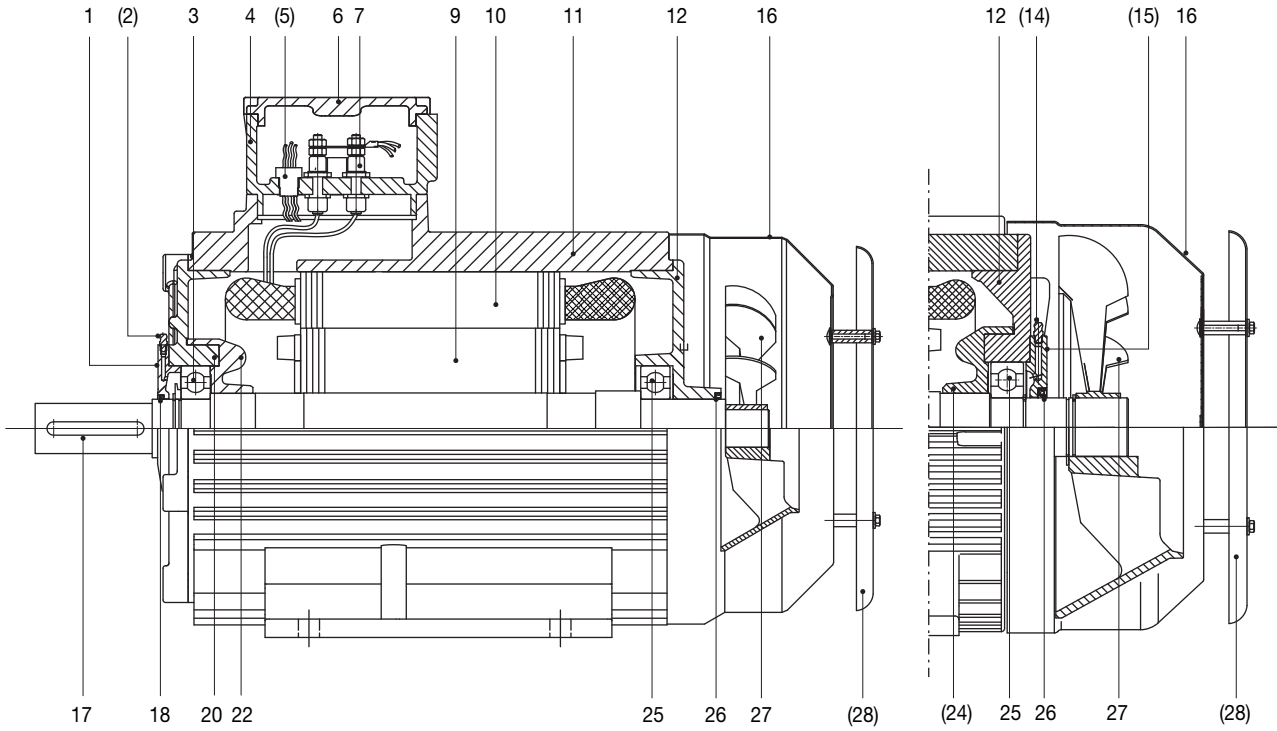

280 ÷ 315

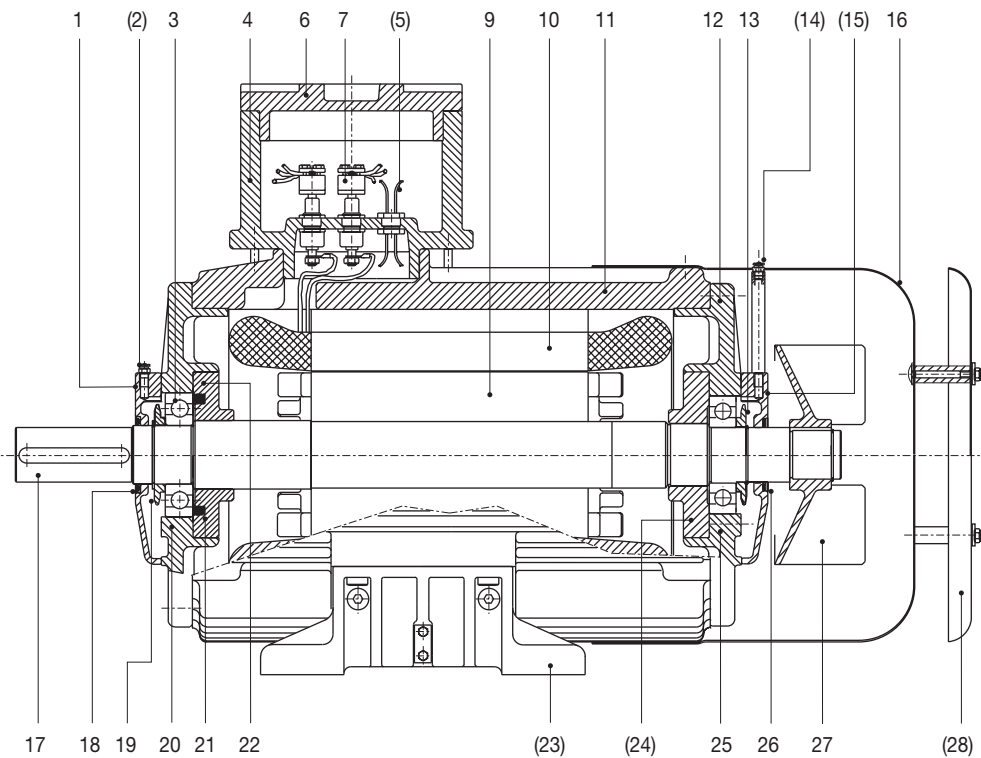

## GB

1 End cap - front	11 Frame	20 Endshield - front
(2) Grease nipple - front	12 Endshield - rear	21 Pre loading springs
3 Front bearing	13 Grease sealing ring - rear	22 Inner bearing cap - front
4 Terminal box	(14) Grease nipple - rear	(23) Feet
(5) Auxiliary connections	(15) End cap - rear	(24) Inner bearing cap - rear
6 Terminal box lid	16 Fan cover (cowl)	25 Rear bearing
7 Terminal board	17 Shaft	26 Sealing ring - rear
9 Rotor	18 Sealing ring - front	27 Cooling fan
10 Stator	19 Grease sealing ring - front	(28) Rain cap
		(...) = when provided

## F

1 Couvercle avant	11 Carcasse	20 Flasque avant
(2) Graisseur avant	12 Flasque arrière	21 Ressorts de précharge
3 Roulement avant	13 Bague arrière de rétention graisse	22 Flasque intérieur avant
4 Boîte à bornes	(14) Graisseur arrière	(23) Pattes
(5) Dispositif pour le passage des auxiliaires	(15) Couvercle arrière	(24) Flasque intérieur arrière
6 Couvercle boîte à bornes	16 Capot de ventilateur	25 Roulement arrière
7 Bornes traversante	17 Arbre	26 Bague arrière d'étanchéité
9 Rotor	18 Bague avant d'étanchéité	27 Ventilateur
10 Stator	19 Bague avant de rétention graisse	(28) Tôle parapluie
		(...) = si prévu

## D

1 Äußerer Fettkammerdeckel A-Seite	11 Motorgehäuse	20 Lagerschild A-Seite
(2) Schmiernippel A-Seite	12 Lagerschild B-Seite	21 Lagervorspannung
3 Kugellager A-Seite	13 Schmierfett – Schleuderring B-Seite	22 Innerer Fettkammerdeckel A-Seite
4 Klemmkasten	(14) Schmiernippel B-Seite	(23) Füße
(5) Kabeldurchführung Hilfskreise	(15) Äußerer Fettkammerdeckel B-Seite	(24) Innerer Fettkammerdeckel B-Seite
6 Klemmkastendeckel	16 Lüfterhaube	25 Kugellager B-Seite
7 Klemmbrett	17 Welle	26 Dichtungsring B-Seite
9 Läufer	18 Dichtungsring A-Seite	27 Lüfterflügel
10 Statorpaket	19 Schmierfett Schleuderring A-Seite	(28) Regenschutzdach
		(...) = wenn vorgesehen

## E

1 Tapa externa delantera	11 Armazón	20 Escudo delantero
(2) Engrasador delantero	12 Escudo trasero	21 Muelles de carga previa
3 Cojinete delantero	13 Anillo retención grasa trasero	22 Fondo interno delantero
4 Caja de bornes	(14) Engrasador trasero	(23) Pies
(5) Niple paso auxiliares	(15) Fondo externo trasero	(24) Tapa interna trasera
6 Tapa de la caja de bornes	16 Casquete cobre ventilador	25 Cojinete trasero
7 Placa de bornes	17 Eje	26 Anillo de retención trasero
9 Rotor	18 Anillo de retención delantero	27 Ventilador
10 Estator	19 Anillo retención grasa delantero	(28) Tapa de protección contra la lluvia
		(...) = cuando previsto

## I

1 Fondello esterno anteriore	11 Carcassa	20 Scudo anteriore
(2) Ingrassatore anteriore	12 Scudo posteriore	21 Molle di precarico
3 Cuscinetto anteriore	13 Anello ritenzione grasso posteriore	22 Fondello interno anteriore
4 Scatola morsetti	(14) Ingrassatore posteriore	(23) Piedi
(5) Nipplo passaggio ausiliari	(15) Fondello esterno posteriore	(24) Fondello interno posteriore
6 Coperchio scatola morsetti	16 Calotta copriventola	25 Cuscinetto posteriore
7 Morsettiera	17 Albero	26 Anello di tenuta posteriore
9 Rotore	18 Anello di tenuta anteriore	27 Ventola
10 Statore	19 Anello ritenzione grasso anteriore	(28) Tettuccio parapigioggia
		(...) = quando previsto

Sales programme	Programme	Verkaufsprogramm	Programa de venta	Programma di vendita
-----------------	-----------	------------------	-------------------	----------------------

**Flameproof-Explosion proof motors**
**Ex d, Ex de**

- frame size 56 ÷ 315
- power 0.06 ÷ 200 kW
- threephase, 1 or 2 speed, singlephase
- ventilated, unventilated
- group I, IIA, IIB, IIC
- category M2, 2G, 2D, 2GD
- temperature class T3, T4, T5, T6
- maximum surface temperature [°C] T150, 135, 125, 100, 85, 70
- with brake

**Moteurs antidéflagrants**
**Ex d, Ex de**

- hauteur d'axe 56 ÷ 315
- puissance 0.06 ÷ 200 kW
- triphasés, à 1 ou 2 vitesses, monophasés
- ventilés, non ventilés
- groupe I, IIA, IIB, IIC
- catégorie M2, 2G, 2D, 2GD
- classes de température T3, T4, T5, T6
- température superficielle maximum [°C] T150, 135, 125, 100, 85, 70
- avec frein

**Explosiongeschützte Motoren**
**Ex d, Ex de**

- Baugrößen 56 ÷ 315
- Leistung 0.06 ÷ 200 kW
- Drehstrommotoren, 1 oder 2 Geschwindigkeiten, Einphasenmotoren
- mit Lüftung, ohne Lüftung
- Gruppe I, IIA, IIB, IIC
- Kategorie M2, 2G, 2D, 2GD
- Temperaturklassen T3, T4, T5, T6
- maximale Oberflächen-temperatur [°C] T150, 135, 125, 100, 85, 70
- mit Bremse

**Motores antideflagrantes**
**Ex d, Ex de**

- tamaños 56 ÷ 315
- potencia 0.06 ÷ 200 kW
- trifásicos, 1 o 2 velocidades, monofásicos
- autoventilados o no
- grupo I, IIA, IIB, IIC
- categoría M2, 2G, 2D, 2GD
- clase temperatura T3, T4, T5, T6
- máxima temperatura superficial [°C] T150, 135, 125, 100, 85, 70
- con freno

**Motori antideflagranti**
**Ex d, Ex de**

- altezza d'asse 56 ÷ 315
- potenze 0.06 ÷ 200 kW
- trifase, 1 o 2 velocità, monofase
- ventilato, non ventilato
- gruppo I, IIA, IIB, IIC
- categoria M2, 2G, 2D, 2GD
- classi di temperatura T3, T4, T5, T6
- massima temperatura superficiale [°C] T150, 135, 125, 100, 85, 70
- con freno

**Increased safety motors**
**Ex e**

- frame size 63 ÷ 132
- power 0.12 ÷ 7.5 kW
- threephase
- group II
- category 2G
- temperature class T3

**Moteurs à sécurité augmentée**
**Ex e**

- hauteur d'axe 63 ÷ 132
- puissance 0.12 ÷ 7.5 kW
- triphasés
- groupe II
- catégorie 2G
- classes de température T3

**Motoren für erhöhte Sicherheit**
**Ex e**

- Baugrößen 63 ÷ 132
- Leistung 0.12 ÷ 7.5 kW
- Drehstrommotoren
- Gruppe II
- Kategorie 2G
- Temperaturklassen T3

**Motores de seguridad aumentada**
**Ex e**

- tamaños 63 ÷ 132
- potencia 0.12 ÷ 7.5 kW
- trifásicos
- grupo II
- categoría 2G
- clase temperatura T3

**Motori a sicurezza aumentata**
**Ex e**

- altezza d'asse 63 ÷ 132
- potenze 0.12 ÷ 7.5 kW
- trifase
- gruppo II
- categoria 2G
- classe di temperatura T3

**Non sparking motors**
**Ex nA**

- frame size 63 ÷ 315
- power 0.12 ÷ 132 kW
- threephase, 1 or 2 speed
- group II
- category 3G, 3GD
- temperature class T3

**Moteurs anti-étincelles**
**Ex nA**

- hauteur d'axe 63 ÷ 315
- puissance 0.12 ÷ 132 kW
- triphasés, à 1 ou 2 vitesses
- groupe II
- catégorie 3G, 3GD
- classes de température T3

**Funkenfreie Motoren**
**Ex nA**

- Baugrößen 63 ÷ 315
- Leistung 0.12 ÷ 132 kW
- Drehstrommotoren, 1 oder 2 Geschwindigkeiten
- Gruppe II
- Kategorie 3G, 3GD
- Temperaturklassen T3

**Motores no sparking**
**Ex nA**

- tamaños 63 ÷ 315
- potencia 0.12 ÷ 132 kW
- trifásicos, 1 o 2 velocidades
- grupo II
- categoría 3G, 3GD
- clase temperatura T3

**Motori non sparking**
**Ex nA**

- altezza d'asse 63 ÷ 315
- potenze 0.12 ÷ 132 kW
- trifase, 1 o 2 velocità
- gruppo II
- categoria 3G, 3GD
- classe di temperatura T3

**Totally enclosed fan cooled IEC motors**

- frame size 63 ÷ 315
- power 0.12 ÷ 132 kW
- threephase, 1 or 2 speed
- category 3D
- protection IP55

**Moteurs fermés IP55 CEI/IEC avec ventilation extérieure**

- hauteur d'axe 63 ÷ 315
- puissance 0.12 ÷ 132 kW
- triphasés, à 1 ou 2 vitesses
- catégorie 3D
- protection IP55

**Geschlossene Motoren mit Fremdbelüftung nach IEC**

- Baugrößen 63 ÷ 315
- Leistung 0.12 ÷ 132 kW
- Drehstrommotoren, 1 oder 2 Geschwindigkeiten
- Kategorie 3D
- Schutzart IP55

**Motores cerrados con ventilación exterior IP55**

- tamaños 63 ÷ 315
- potencia 0.12 ÷ 132 kW
- trifásicos, 1 o 2 velocidades
- categoría 3D
- protección IP55

**Motori chiusi con ventilazione esterna CEI/IEC**

- altezza d'asse 63 ÷ 315
- potenze 0.12 ÷ 132 kW
- trifase, 1 o 2 velocità
- categoria 3D
- protezione IP55

**Centrifugal flameproof electric pumps for printing machines**
**Ex d - Ex de**

- group IIB, IIC
- output over 300 l/min
- head up to 15 m
- stem length 170 ÷ 550 mm
- special applications
- detachable motor from the pump unit

**Electropompes centrifuges antidéflagrantes pour machines d'imprimerie**
**Ex d - Ex de**

- groupe IIB, IIC
- débit supérieur à 300 l/min
- hauteur de refoulement jusqu'à 15 m
- corps immergé 170 ÷ 550 mm
- applications spéciales
- moteur détachable de l'unité pompe

**Explosiongeschützte Zentrifugal-Elektropumpen für Druckmaschinen**
**Ex d - Ex de**

- Gruppe IIB, IIC
- Leistung bis 300 l/min
- Bis zu 15 m Förderhöhe
- Eintauchtiefe 170 ÷ 550 mm
- Sonderanwendungen
- Motor vom Pumpenkörper abnehmbar

**Electrobombas centrifugas antideflagrantes para máquinas de impresión**
**Ex d - Ex de**

- grupo IIB, IIC
- capacidad: más 300 l/min
- altura: hasta 15 m
- cuerpos sumergidos 170 ÷ 550 mm
- aplicaciones especiales
- motor separable del cuerpo bomba

**Elettropompe centrifughe antideflagranti per macchine da stampa**
**Ex d - Ex de**

- gruppo IIB, IIC
- portate oltre 300 l/min
- prevalenze: fino a 15 m
- corpi immersi 170 ÷ 550 mm
- applicazioni speciali
- motore separabile dal corpo pompa

**Centrifugal electric pumps for machine tools**

- submersible
- output over 300 l/min
- head up to 30 m
- stem length 90 ÷ 550 mm
- special applications

**Electropompes centrifuges pour machines-outils**

- immergeables
- débit supérieur à 300 l/min
- hauteur de refoulement jusqu'à 30 m
- corps immergé 90 ÷ 550 mm
- applications spéciales

**Elektropumpen für Werkzeugmaschinen**

- Eintauchfähig
- Leistung mehr als 300 l/min
- Bis zu 30 m Förderhöhe
- Eintauchtiefe 90 ÷ 550 mm
- Sonderanwendungen

**Electrobombas centrifugas para máquinas herramientas**

- sumergibles
- capacidad: más 300 l/min
- altura: hasta 30 m
- cuerpos sumergidos 90 ÷ 550 mm
- aplicaciones especiales

**Elettropompe centrifughe per macchine utensili**

- ad immersione
- portate oltre 300 l/min
- prevalenze fino a 30 m
- corpi immersi 90 ÷ 550 mm
- applicazioni speciali

Every care has been taken to ensure the accuracy of the information contained in this publication.

Due to Cemp's policy of continuous development and improvement, the company reserves the right to supply products which may differ slightly from those illustrated and described in this publication.

Descriptions and technical features listed in this brochure may not be considered as binding. Under no circumstances should data in this publication be considered as a contractual obligation.

Dans la préparation de cette documentation nous avons pris le soin d'y intégrer les informations les plus exactes possibles.

Néanmoins, compte tenu de notre politique de développement et d'amélioration continue des produits, la Société Cemp se réserve le droit et la faculté d'apporter toute modification sur la documentation et sur les produits, à tout moment et sans préavis.

Les descriptifs et les caractéristiques techniques contenus dans ce catalogue n'engagent pas la Société. Par conséquent, ces données ne constituent en aucun cas un engagement contractuel.

Die Ausführungen und technischen Eigenschaften, die in dieser Broschüre angegeben sind, dürfen nicht als verbindlich angesehen werden.

In keinem Fall können jedoch die in diesem Dokument aufgeführten technischen Daten als rechtlich verbindlich angesehen werden.

Cemp behält sich das Recht vor, ohne Mitteilung, jegliche Abweichungen und Änderungen jederzeit vorzunehmen, sowohl in diesem Dokument als auch bei den Produkten, die hier beschrieben sind.

La presente documentación se ha redactado de manera muy atenta para poder asegurar que las informaciones que contiene son correctas.

No obstante, como consecuencia de la política de continuo desarrollo y mejora de la calidad del producto que Cemp pone en práctica, la sociedad se reserva el derecho y la facultad de modificar en lo que fuera necesario, en cualquier momento y sin que para ello medie preaviso alguno, tanto este documento como sus productos.

Por lo tanto, las descripciones y las características técnicas indicadas en el presente documento no son vinculantes, y los datos que contiene no constituyen en ningún caso, vínculo contractual.

Nel redigere questa documentazione è stata posta ogni cura al fine di assicurare la correttezza delle informazioni contenute.

Tuttavia, anche in conseguenza della politica di continuo sviluppo e miglioramento della qualità del prodotto perseguita da Cemp, la società si riserva il diritto e la facoltà di apportare modifiche di qualsiasi genere, in qualsiasi momento e senza preavviso, sia a questo documento sia ai propri prodotti.

Le descrizioni e le caratteristiche tecniche della presente pubblicazione non sono quindi impegnative e i dati riportati non costituiscono, in nessun caso, impegno contrattuale.

### **Cemp srl**

Via Piemonte, 16  
I 20030 SENAGO (MI)  
Tel. +39 02 94 43 54 01  
Fax +39 02 99 89 177  
cemp@cemp.eu  
www.cemp.eu

---



### **Cemp France SA**

6 et 8, avenue Victor Hugo  
F 27320 NONANCOURT  
Tél. +33 (0)2 32 58 03 81  
Fax +33 (0)2 32 32 12 98  
cemp-france@cemp.eu  
www.cemp.eu

---

### **Cemp International GmbH**

Am Mollnhof 2  
D 94036 PASSAU  
Tel. +49 (0)851 96 62 320  
Fax +49 (0)851 96 62 32 13  
cemp-deutschland@cemp.eu  
www.cemp.eu

---

**Overall sales network at [www.cemp.eu](http://www.cemp.eu)**

---