

Valid as of version:  
V 3.01.XX (device software, HART 5)  
V 3.07.XX (device software, HART 7)

# Operating Instructions

## Proline Promass 83

### HART

Coriolis Mass Flow Measuring System

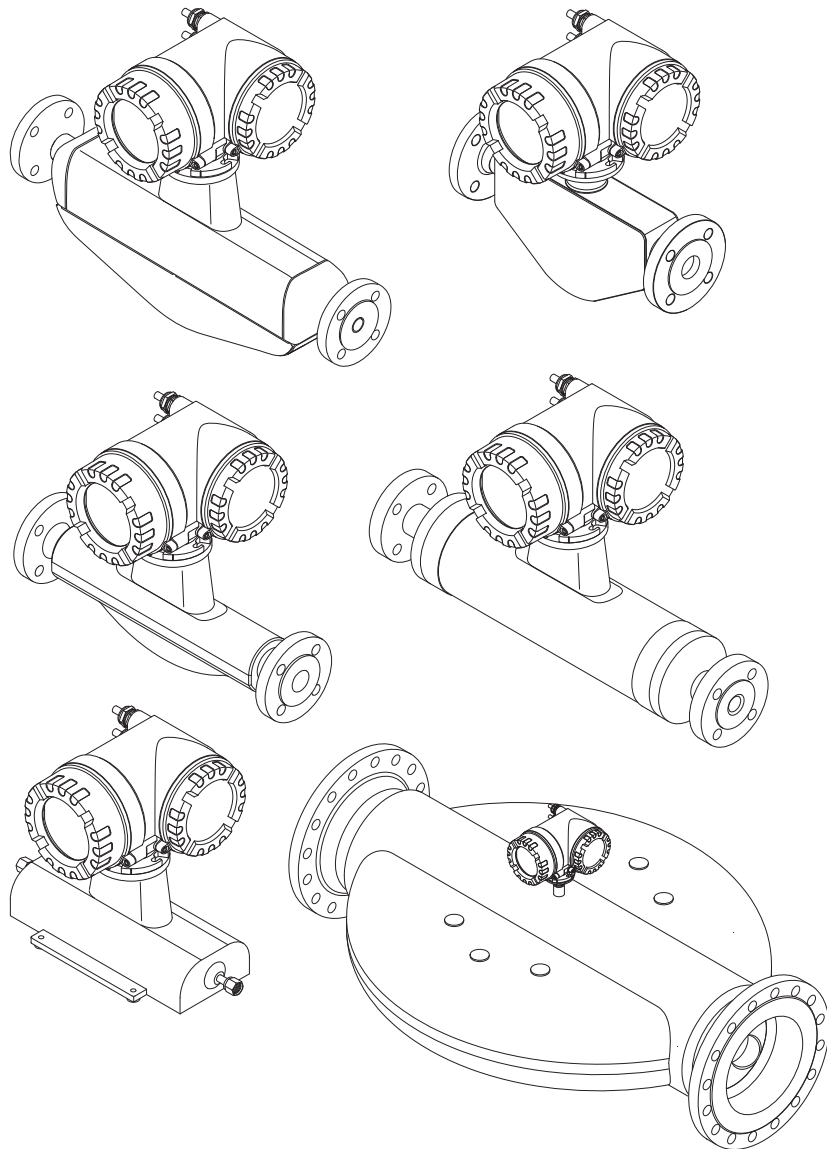



## Table of contents

<b>1</b>	<b>Safety instructions</b> .....	<b>4</b>	<b>9</b>	<b>Troubleshooting</b> .....	<b>87</b>
1.1	Designated use .....	4	9.1	Troubleshooting instructions .....	87
1.2	Installation, commissioning and operation .....	4	9.2	System error messages .....	88
1.3	Operational safety .....	5	9.3	Process error messages .....	93
1.4	Return .....	5	9.4	Process errors without messages .....	95
1.5	Notes on safety conventions and icons .....	5	9.5	Response of outputs to errors .....	96
<b>2</b>	<b>Identification</b> .....	<b>6</b>	9.6	Spare parts .....	97
2.1	Device designation .....	6	9.7	Return .....	103
2.2	Certificates and approvals .....	10	9.8	Disposal .....	103
2.3	Registered trademarks .....	10	9.9	Software history .....	103
<b>3</b>	<b>Installation</b> .....	<b>11</b>	<b>10</b>	<b>Technical data</b> .....	<b>106</b>
3.1	Incoming acceptance, transport and storage ...	11	10.1	Applications .....	106
3.2	Installation conditions .....	13	10.2	Function and system design .....	106
3.3	Installation .....	21	10.3	Input .....	106
3.4	Post-installation check .....	24	10.4	Output .....	109
<b>4</b>	<b>Wiring</b> .....	<b>25</b>	10.5	Power supply .....	110
4.1	Connecting the remote version .....	25	10.6	Performance characteristics .....	111
4.2	Connecting the measuring unit .....	26	10.7	Installation .....	131
4.3	Degree of protection .....	30	10.8	Environment .....	131
4.4	Post-connection check .....	30	10.9	Process .....	132
<b>5</b>	<b>Operation</b> .....	<b>31</b>	10.10	Mechanical construction .....	135
5.1	Display and operating elements .....	31	10.11	Operability .....	141
5.2	Brief operating instructions to the function matrix 35		10.12	Certificates and approvals .....	141
5.3	Error messages .....	37	10.13	Ordering information .....	142
5.4	Communication .....	38	10.14	Accessories .....	142
<b>6</b>	<b>Commissioning</b> .....	<b>56</b>	10.15	Supplementary Documentation .....	143
6.1	Function check .....	56			
6.2	Switching on the measuring device .....	56			
6.3	Quick Setup .....	57			
6.4	Configuration .....	69			
6.5	Adjustment .....	79			
6.6	Purge and pressure monitoring connections ...	83			
6.7	Data memory (HistoROM), F-CHIP .....	83			
<b>7</b>	<b>Maintenance</b> .....	<b>84</b>			
7.1	Exterior cleaning .....	84			
7.2	Cleaning with pigs (Promass H, I, S, P) .....	84			
7.3	Replacing seals .....	84			
<b>8</b>	<b>Accessories</b> .....	<b>85</b>			
8.1	Device-specific accessories .....	85			
8.2	Measuring principle-specific accessories .....	85			
8.3	Communication-specific accessories .....	86			
8.4	Service-specific accessories .....	86			
				<b>Index</b> .....	<b>144</b>

# 1 Safety instructions

## 1.1 Designated use

The measuring device described in these Operating Instructions is to be used only for measuring the mass flow rate of liquids and gases. At the same time, the system also measures fluid density and fluid temperature. These parameters are then used to calculate other variables such as volume flow. Fluids with widely differing properties can be measured.

Examples:

- Oils, fats
- Acids, alkalis, lacquers, paints, solvents and cleaning agents
- Pharmaceuticals, catalysts, inhibitors
- Suspensions
- Gases, liquefied gases, etc.
- Chocolate, condensed milk, liquid sugar

Resulting from incorrect use or from use other than that designated the operational safety of the measuring devices can be suspended. The manufacturer accepts no liability for damages being produced from this.



## 1.2 Installation, commissioning and operation

Note the following points:

- Installation, connection to the electricity supply, commissioning and maintenance of the device must be carried out by trained, qualified specialists authorized to perform such work by the facility's owner operator. The specialist must have read and understood these Operating Instructions and must follow the instructions they contain.
- The device must be operated by persons authorized and trained by the facility's owner-operator. Strict compliance with the instructions in the Operating Instruction is mandatory.
- Endress+Hauser is willing to assist in clarifying the chemical resistance properties of parts wetted by special fluids, including fluids used for cleaning. However, small changes in temperature, concentration or the degree of contamination in the process can result in changes of the chemical resistance properties. Therefore, Endress+Hauser can not guarantee or accept liability for the chemical resistance properties of the fluid wetted materials in a specific application. The user is responsible for the choice of fluid wetted materials in regards to their in-process resistance to corrosion.
- If carrying out welding work on the piping, the welding unit may not be grounded by means of the measuring device.
- The installer must ensure that the measuring system is correctly wired in accordance with the wiring diagrams. The transmitter must be earthed unless special protection measures have been taken e.g. galvanically isolated power supply SELV or PELV (SELV = Safe Extra Low Voltage; PELV = Protective Extra Low Voltage).
- Invariably, local regulations governing the opening and repair of electrical devices apply.

## 1.3 Operational safety

Note the following points:

- Measuring systems for use in hazardous environments are accompanied by separate "Ex documentation", which is an integral part of these Operating Instructions. Strict compliance with the installation instructions and ratings as stated in this supplementary documentation is mandatory. The symbol on the front of this supplementary Ex documentation indicates the approval and the certification body (e.g.  Europe,  USA,  Canada).
- The measuring device complies with the general safety requirements in accordance with EN 61010-1, the EMC requirements of IEC/EN 61326, and NAMUR Recommendation NE 21, NE 43 and NE 53.
- For measuring systems used in SIL 2 applications, the separate manual on functional safety must be observed.
- External surface temperature of the transmitter can increase by 10 K due to power consumption of internal electrical components. Hot process fluids passing through the measuring device will further increase the surface temperature of the measuring device. Especially the surface of the sensor can reach temperatures which are close to process temperature. Additionally safety precautions are required when increased process temperatures are present.
- The manufacturer reserves the right to modify technical data without prior notice. Your Endress+Hauser distributor will supply you with current information and updates to these Operating Instructions.

## 1.4 Return

- Do not return a measuring device if you are not absolutely certain that all traces of hazardous substances have been removed, e.g. substances which have penetrated crevices or diffused through plastic.
- Costs incurred for waste disposal and injury (burns, etc.) due to inadequate cleaning will be charged to the owner-operator.
- Please note the measures on →  103

## 1.5 Notes on safety conventions and icons

The devices are designed to meet state-of-the-art safety requirements, have been tested, and left the factory in a condition in which they are safe to operate. The devices comply with the applicable standards and regulations in accordance with EN 61010-1 "Protection Measures for Electrical Equipment for Measurement, Control, Regulation and Laboratory Procedures". The devices can, however, be a source of danger if used incorrectly or for other than the designated use.

Consequently, always pay particular attention to the safety instructions indicated in these Operating Instructions by the following icons:



Warning!

"Warning" indicates an action or procedure which, if not performed correctly, can result in injury or a safety hazard. Comply strictly with the instructions and proceed with care.



Caution!

"Caution" indicates an action or procedure which, if not performed correctly, can result in incorrect operation or destruction of the device. Comply strictly with the instructions.



Note!

"Note" indicates an action or procedure which, if not performed correctly, can have an indirect effect on operation or trigger an unexpected response on the part of the device.

## 2 Identification

The following options are available for identification of the measuring device::

- Nameplate specifications
- Order code with breakdown of the device features on the delivery note
- Enter serial numbers from nameplates in *W@M Device Viewer* ([www.endress.com/deviceviewer](http://www.endress.com/deviceviewer)): All information about the measuring device is displayed.

For an overview of the scope of the Technical Documentation provided, refer to the following:

- The chapters "Supplementary Documentation" →  143
- Der *W@M Device Viewer*: Enter the serial number from the nameplate ([www.endress.com/deviceviewer](http://www.endress.com/deviceviewer))

### Reorder

The measuring device is reordered using the order code.

Extended order code:

- The device type (product root) and basic specifications (mandatory features) are always listed.
- Of the optional specifications (optional features), only the safety and approval-related specifications are listed (e.g. LA). If other optional specifications are also ordered, these are indicated collectively using the # placeholder symbol (e.g. #LA#).
- If the ordered optional specifications do not include any safety and approval-related specifications, they are indicated by the + placeholder symbol (e.g. 8E2B50-ABCDE+).

### 2.1 Device designation

The "Promass 83" flow measuring system consists of the following components:

- Promass 83 transmitter.
- Promass F, Promass E, Promass A, Promass H, Promass I, Promass S, Promass P, Promass O or Promass X sensor.

Two versions are available:

- Compact version: transmitter and sensor form a single mechanical unit.
- Remote version: transmitter and sensor are installed separately.

### 2.1.1 Nameplate of the transmitter

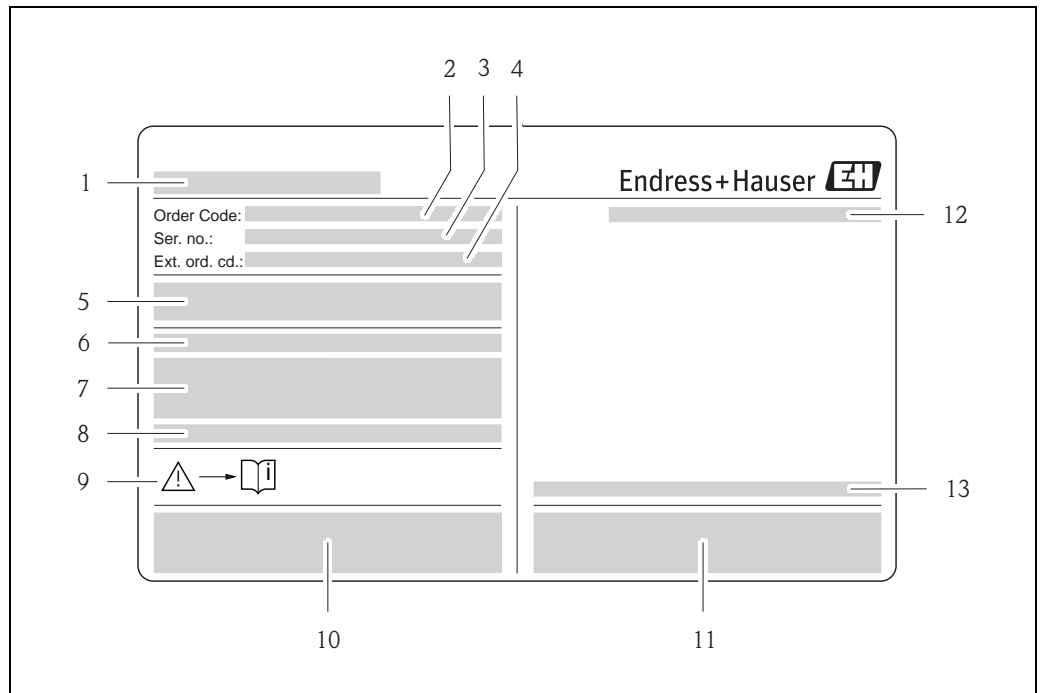

Fig. 1: Example of a transmitter nameplate

- 1 Name of the transmitter
- 2 Order code
- 3 Serial number (Ser. no.)
- 4 Extended order code (Ext. ord. cd.)
- 5 Power supply, frequency and power consumption
- 6 Additional function and software
- 7 Available inputs / outputs
- 8 Reserved for information on special products
- 9 Please refer to operating instructions / documentation
- 10 Reserved for certificates, approvals and for additional information on device version
- 11 Patents
- 12 Degree of protection
- 13 Ambient temperature range

A0015928

### 2.1.2 Nameplate of the sensor

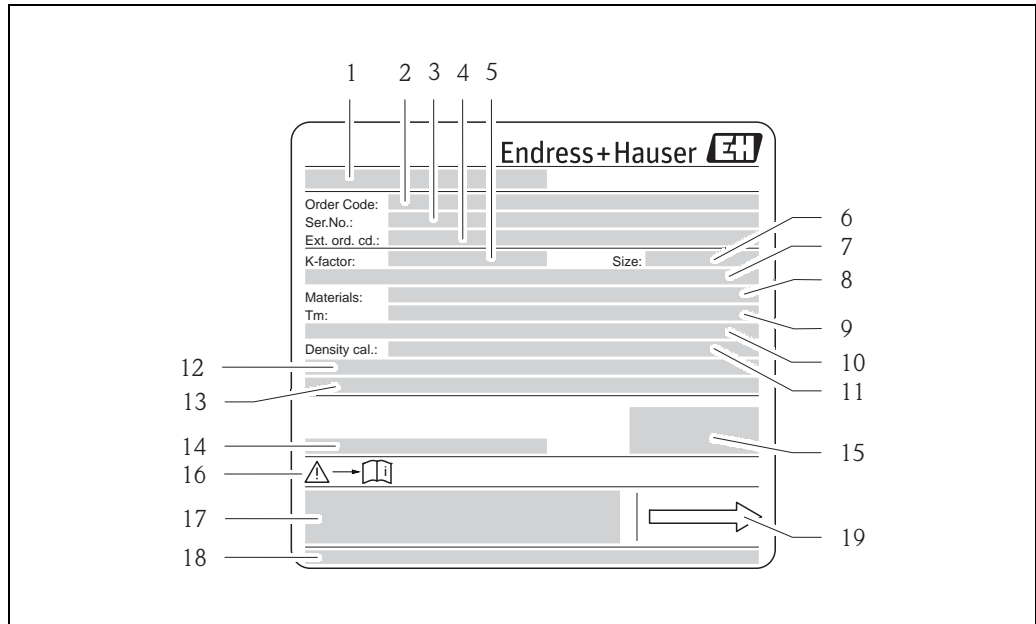

Fig. 2: Example of a sensor nameplate

- 1 Name of the sensor
- 2 Order code
- 3 Serial number (Ser. no.)
- 4 Extended order code (Ext. ord. cd.)
- 5 Calibration factor with zero point (K-factor)
- 6 Nominal diameter device (Size)
- 7 Flange nominal diameter/Nominal pressure
- 8 Material of measuring tubes (Materials)
- 9 Max. fluid temperature (Tm)
- 10 Pressure range of secondary containment
- 11 Accuracy of density measurement (Density cal.)
- 12 Additional information
- 13 Reserved for information on special products
- 14 Ambient temperature range
- 15 Degree of protection
- 16 Please refer to operating instructions / documentation
- 17 Reserved for additional information on device version (approvals, certificates)
- 18 Patents
- 19 Flow direction



### 2.1.3 Nameplate for connections

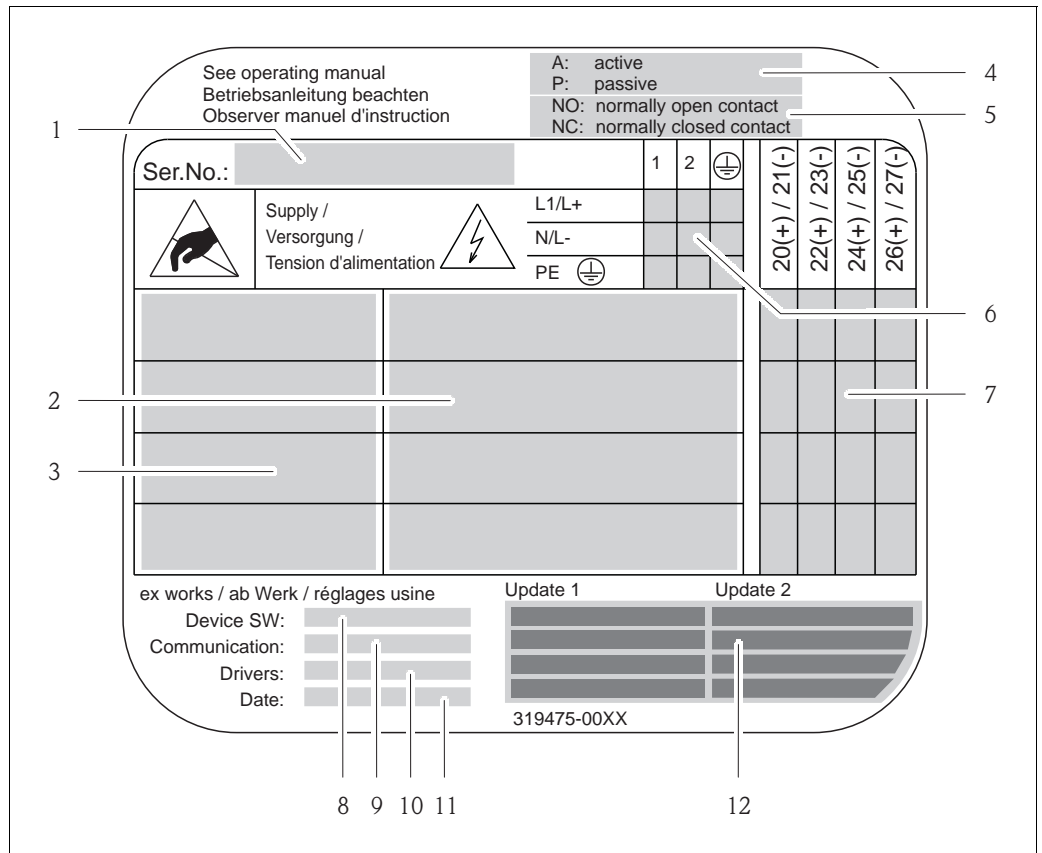



Fig. 3: Example of a connection nameplate

- 1 Serial number (Ser. no.)
- 2 Possible inputs and outputs
- 3 Signals present at inputs and outputs
- 4 Possible configuration of current output
- 5 Possible configuration of relay contacts
- 6 Terminal assignment, cable for power supply
- 7 Terminal assignment and configuration (see point 4 and 5) of inputs and outputs
- 8 Version of device software currently installed (Device SW)
- 9 Installed communication type (Communication)
- 10 Information on current communication software (Drivers: Device Revision and Device Description),
- 11 Date of installation (Date)
- 12 Current updates to data specified in points 8 to 11 (Update1, Update 2)

## 2.2 Certificates and approvals

The devices are designed in accordance with good engineering practice to meet state-of-the-art safety requirements, have been tested, and left the factory in a condition in which they are safe to operate. See also "Certificates and approvals" →  141.

The devices comply with the applicable standards and regulations in accordance with EN 61010-1 "Protection Measures for Electrical Equipment for Measurement, Control, Regulation and Laboratory Procedures" and with the EMC requirements of IEC/EN 61326. The measuring system described in these Operating Instructions thus complies with the statutory requirements of the EC Directives. Endress+Hauser confirms successful testing of the device by affixing to it the CE mark.

The measuring system meets the EMC requirements of the "Australian Communications and Media Authority (ACMA)".

## 2.3 Registered trademarks

KALREZ<sup>®</sup> and VITON<sup>®</sup>

Registered trademarks of E.I. Du Pont de Nemours & Co., Wilmington, USA

TRI-CLAMP<sup>®</sup>

Registered trademark of Ladish & Co., Inc., Kenosha, USA

SWAGELOK<sup>®</sup>

Registered trademark of Swagelok & Co., Solon, USA

HART<sup>®</sup>

Registered trademark of HART Communication Foundation, Austin, USA

HistoROM<sup>™</sup>, S-DAT<sup>®</sup>, T-DAT<sup>™</sup>, F-CHIP<sup>®</sup>, FieldCare<sup>®</sup>, Fieldcheck<sup>®</sup>, Field Xpert<sup>™</sup>, Applicator<sup>®</sup>

Registered or registration-pending trademarks of Endress+Hauser Flowtec AG, Reinach, CH

## 3 Installation

### 3.1 Incoming acceptance, transport and storage



#### 3.1.1 Incoming acceptance

On receipt of the goods, check the following points:

- Check the packaging and the contents for damage.
- Check the shipment, make sure nothing is missing and that the scope of supply matches your order.

#### 3.1.2 Transport

The following instructions apply to unpacking and to transporting the device to its final location:

- Transport the devices in the containers in which they are delivered.
- The covers or caps fitted to the process connections prevent mechanical damage to the sealing faces and the ingress of foreign matter to the measuring tube during transportation and storage. Consequently, do not remove these covers or caps until immediately before installation.
- Do not lift measuring devices of nominal diameters  $> \text{DN } 40$  ( $1\frac{1}{2}$ " ) by the transmitter housing or the connection housing in the case of the remote version ( $\rightarrow$   4). Use webbing slings slung round the two process connections. Do not use chains, as they could damage the housing.
- Promass X, Promass O sensor: see special instructions for transporting  $\rightarrow$   12



Warning!

Risk of injury if the measuring device slips. The center of gravity of the assembled measuring device might be higher than the points around which the slings are slung.

At all times, therefore, make sure that the device does not unexpectedly turn around its axis or slip.

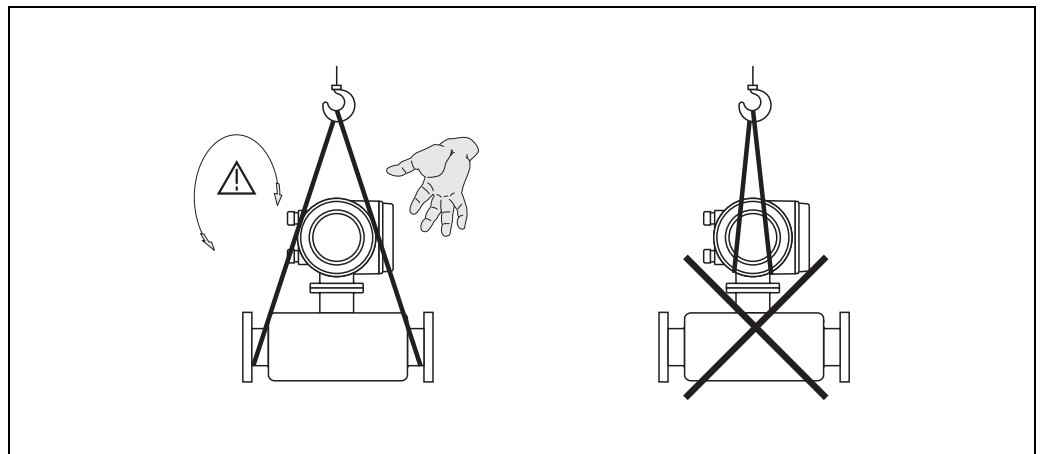

Fig. 4: Instructions for transporting sensors with  $> \text{DN } 40$  ( $1\frac{1}{2}$ " )

a0004294

### Special instructions for transporting Promass X and O



#### Warning!

- For transporting use only the lifting eyes on the flanges to lift the assembly.
- The assembly must always be attached to at least two lifting eyes.

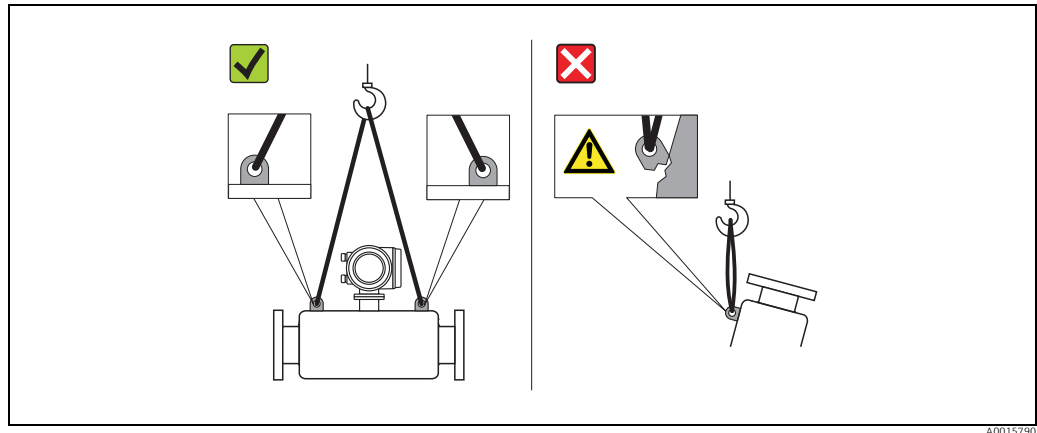

Fig. 5: Instructions for transporting Promass O

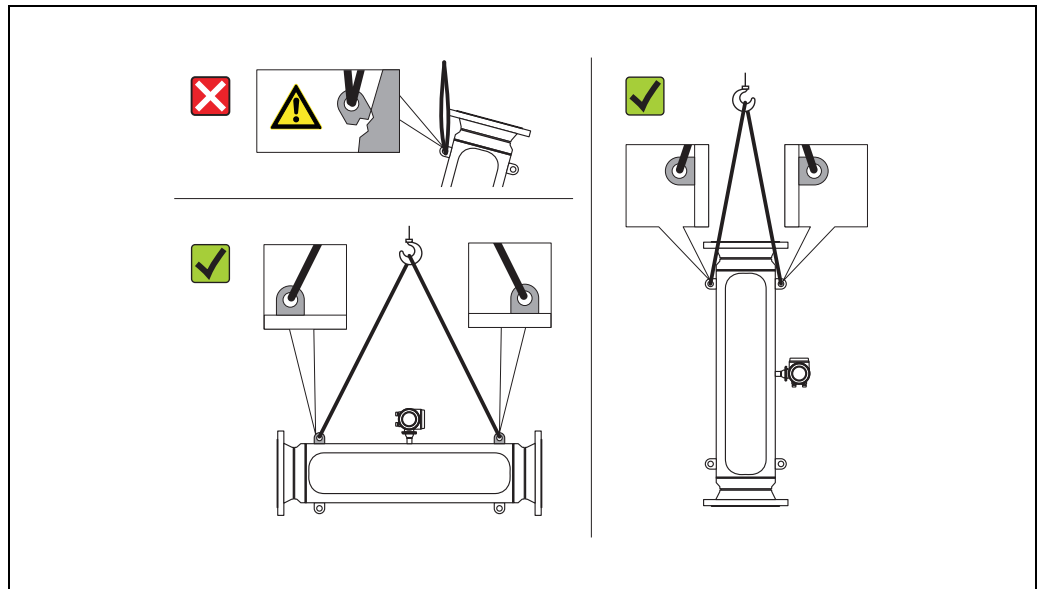

Fig. 6: Instructions for transporting Promass X

### 3.1.3 Storage

Note the following points:

- Pack the measuring device in such a way as to protect it reliably against impact for storage (and transportation). The original packaging provides optimum protection.
- The permissible storage temperature is  $-40$  to  $+80$  °C ( $-40$  to  $+176$  °F), preferably  $+20$  °C ( $+68$  °F).
- Do not remove the protective covers or caps on the process connections until you are ready to install the device.
- The measuring device must be protected against direct sunlight during storage in order to avoid unacceptably high surface temperatures.

## 3.2 Installation conditions

Note the following points:

- No special measures such as supports are necessary. External forces are absorbed by the construction of the instrument, for example the secondary containment.
- The high oscillation frequency of the measuring tubes ensures that the correct operation of the measuring system is not influenced by pipe vibrations.
- No special precautions need to be taken for fittings which create turbulence (valves, elbows, T-pieces, etc.), as long as no cavitation occurs.
- For mechanical reasons and in order to protect the pipe, it is advisable to support heavy sensors.

### 3.2.1 Dimensions

All the dimensions and lengths of the sensor and transmitter are provided in the separate documentation "Technical Information"

### 3.2.2 Mounting location

Entrained air or gas bubbles forming in the measuring tube can result in an increase in measuring errors.

**Avoid** the following locations in the pipe installation:

- Highest point of a pipeline. Risk of air accumulating.
- Directly upstream of a free pipe outlet in a vertical pipeline.

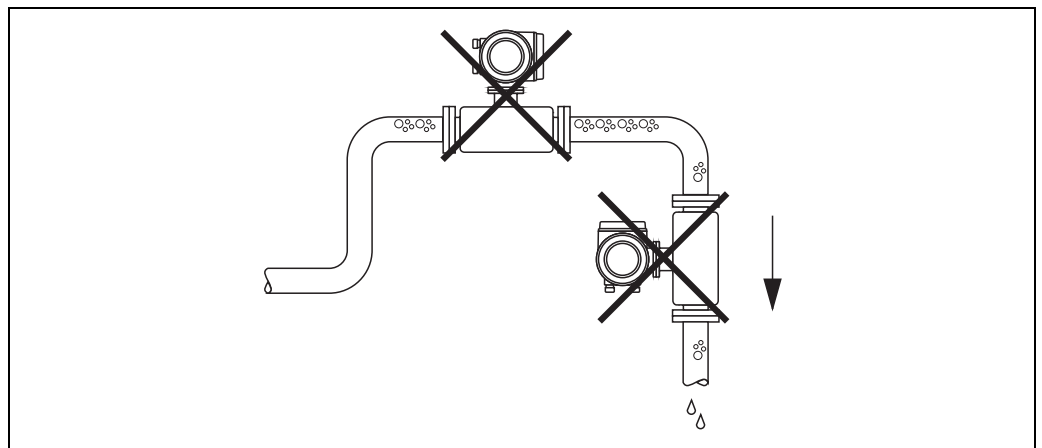

Fig. 7: Mounting location

### Installation in a vertical pipe

The proposed configuration in the following diagram, however, permits installation in a vertical pipeline. Pipe restrictors or the use of an orifice plate with a smaller cross-section than the nominal diameter prevent the sensor from running empty during measurement.

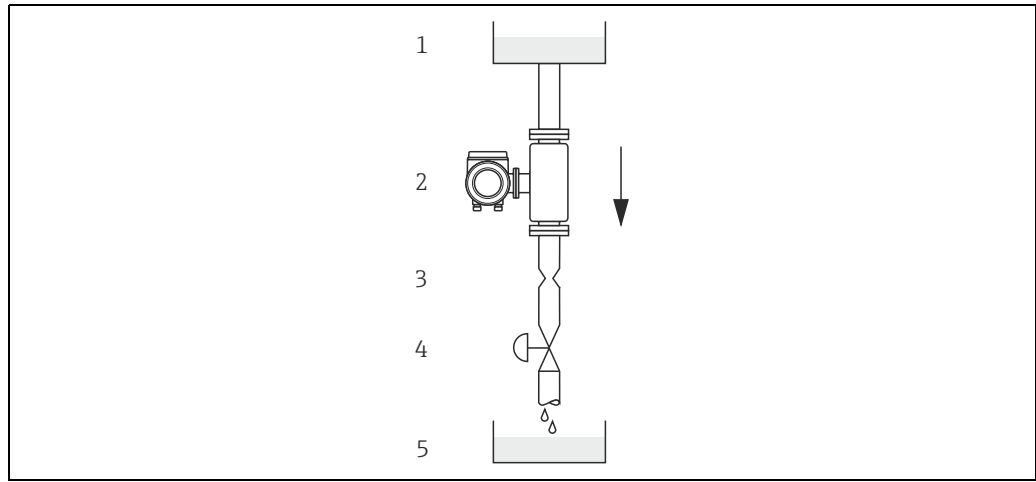

Fig. 8: Installation in a vertical pipe (e.g. for batching applications)  
 1 = Supply tank, 2 = Sensor, 3 = Orifice plate, pipe restrictors (see Table), 4 = Valve, 5 = Batching tank

DN		Ø Orifice plate, pipe restrictor	
		mm	inch
1	1/24"	0.8	0.03
2	1/12"	1.5	0.06
4	1/8"	3.0	0.12
8	3/8"	6	0.24
15	1/2"	10	0.40
15 FB	1/2"	15	0.60
25	1"	14	0.55
25 FB	1"	24	0.95
40	1 1/2"	22	0.87

DN		Ø Orifice plate, pipe restrictor	
		mm	inch
40 FB	1 1/2"	35	1.38
50	2"	28	1.10
50 FB	2"	54	2.00
80	3"	50	2.00
100	4"	65	2.60
150	6"	90	3.54
250	10"	150	5.91
350	14"	210	8.27

FB = Full bore versions of Promass I

### System pressure

It is important to ensure that cavitation does not occur, because it would influence the oscillation of the measuring tube. No special measures need to be taken for fluids which have properties similar to water under normal conditions.

In the case of liquids with a low boiling point (hydrocarbons, solvents, liquefied gases) or in suction lines, it is important to ensure that pressure does not drop below the vapor pressure and that the liquid does not start to boil. It is also important to ensure that the gases that occur naturally in many liquids do not outgas. Such effects can be prevented when system pressure is sufficiently high.

For this reason, the following installation locations are preferred:

- Downstream from pumps (no danger of vacuum)
- At the lowest point in a vertical pipe.

### 3.2.3 Orientation

Make sure that the direction of the arrow on the nameplate of the sensor matches the direction of flow direction in which the fluid flows through the pipe.

#### Orientation Promass A

##### Vertical

Recommended orientation with direction of flow upwards. When fluid is not flowing, entrained solids will sink down and gases will rise away from the measuring tube. The measuring tubes can be completely drained and protected against solids build-up.

##### Horizontal

When installation is correct the transmitter housing is above or below the pipe. This means that no gas bubbles or solids deposits can form in the bent measuring tube (single-tube system).

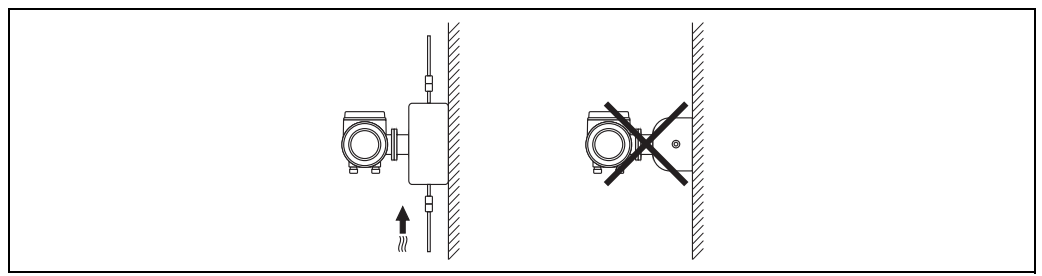

A0018978

#### Special installation instructions for Promass A



Caution!

Risk of measuring pipe fracture if sensor installed incorrectly!

The sensor may not be installed in a pipe as a freely suspended sensor:

- Using the base plate, mount the sensor directly on the floor, the wall or the ceiling.
- Support the sensor on a firmly mounted support base (e.g. angle bracket).

##### Vertical

We recommend two installation versions when mounting vertically:

- Mounted directly on a wall using the base plate
- Measuring device supported on an angle bracket mounted on the wall

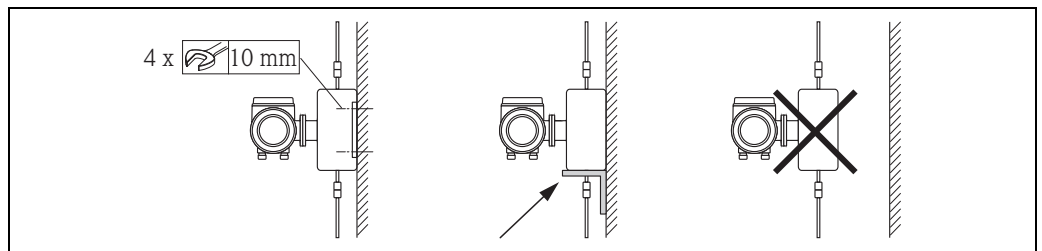

A0018980

##### Horizontal

We recommend the following installation version when mounting horizontally:

- Measuring device standing on a firm support base

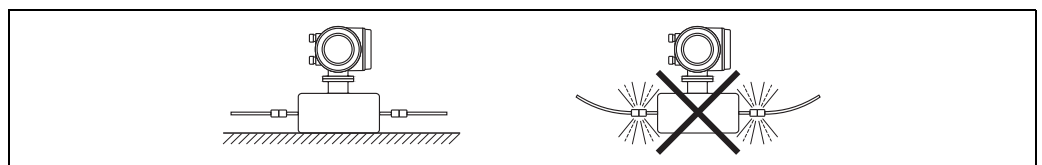

A0018979

**Orientation Promass F, E, H, I, S, P, O, X**

Make sure that the direction of the arrow on the nameplate of the sensor matches the direction of flow (direction in which the fluid flows through the pipe).

Vertical:

Recommended orientation with upward direction of flow (Fig. V). When fluid is not flowing, entrained solids will sink down and gases will rise away from the measuring tube.

The measuring tubes can be completely drained and protected against solids buildup.

Horizontal (Promass F, E, O):

The measuring tubes of Promass F, E and O must be horizontal and beside each other.

When installation is correct the transmitter housing is above or below the pipe (Fig. H1/H2).

Always avoid having the transmitter housing in the same horizontal plane as the pipe.

See next chapter - special installation instructions.

Horizontal (Promass H, I, S, P, X):

Promass H, I, S, P and X can be installed in any orientation in a horizontal pipe run.

Promass H, I, S, P: See next chapter - special installation instructions

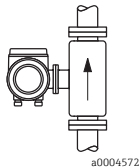
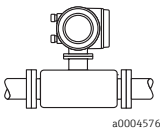
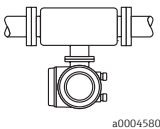
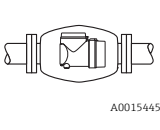
	Promass F, E, O Standard, compact	Promass F, E Standard, remote	Promass F High-temperature, compact	Promass F High-temperature, remote	Promass H, I, S, P	Promass X
<b>Fig. V:</b> Vertical orientation  a0004572	✓✓	✓✓	✓✓	✓✓	✓✓	✓✓
<b>Fig. H1:</b> Horizontal orientation Transmitter head up  a0004576	✓✓	✓✓	8 TM > 200 °C ( 392 °F)	✓ TM > 200 °C ( 392 °F)	✓✓	✓✓
<b>Fig. H2:</b> Horizontal orientation Transmitter head down  a0004580	✓✓	✓✓	✓✓	✓✓	✓✓	✓✓
<b>Fig. H3:</b> Horizontal orientation Transmitter head to the side  A0015445	8	8	8	8	✓✓	✓①
✓✓ = Recommended orientation; ✓ = Orientation recommended in certain situations; 8 = Impermissible orientation ① The measuring tubes are curved. Therefore the unit is installed horizontally, adapt the sensor position to the fluid properties: <ul style="list-style-type: none"> <li>▪ Suitable to a limited extent for fluids with entrained solids. Risk of solids accumulating</li> <li>▪ Suitable to a limited extent for outgassing fluids. Risk of air accumulating</li> </ul>						

In order to ensure that the permissible ambient temperature range for the transmitter (→ 131) is not exceeded, we recommend the following orientations:

- For fluids with very high temperatures we recommend the horizontal orientation with the transmitter head pointing downwards (Fig. H2) or the vertical orientation (Fig. V).
- For fluids with very low temperatures, we recommend the horizontal orientation with the transmitter head pointing upwards (Fig. H1) or the vertical orientation (Fig. V).



### 3.2.4 Special installation instructions

#### Promass F, E, H, S, P and O



Caution!

If the measuring tube is curved and the unit is installed horizontally, adapt the sensor position to the fluid properties.

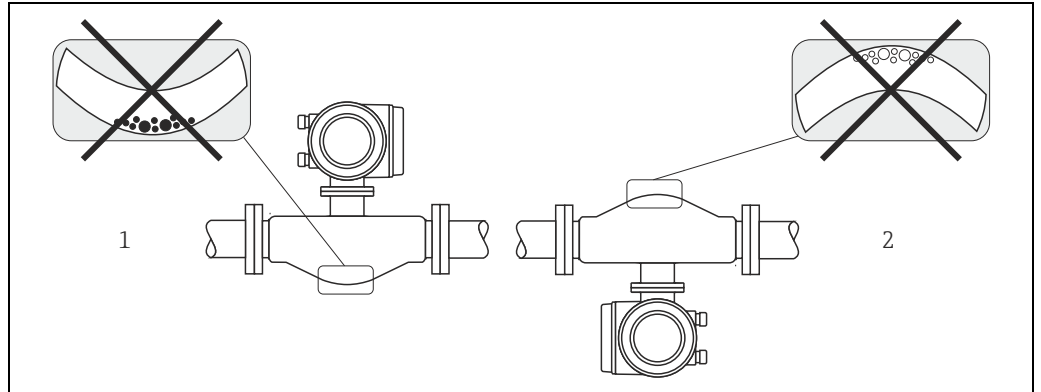

Fig. 9: Horizontal installation of sensors with curved measuring tube.

- 1 Not suitable for fluids with entrained solids. Risk of solids accumulating.
- 2 Not suitable for outgassing fluids. Risk of air accumulating.

#### Promass I and P with Eccentric Tri-clamps

Eccentric Tri-Clamps can be used to ensure complete drainability when the sensor is installed in a horizontal line. When lines are pitched in a specific direction and at a specific slope, gravity can be used to achieve complete drainability. The sensor must be installed in the correct position with the tube bend facing to the side, to ensure full drainability in the horizontal position. Markings on the sensor show the correct mounting position to optimize drainability.

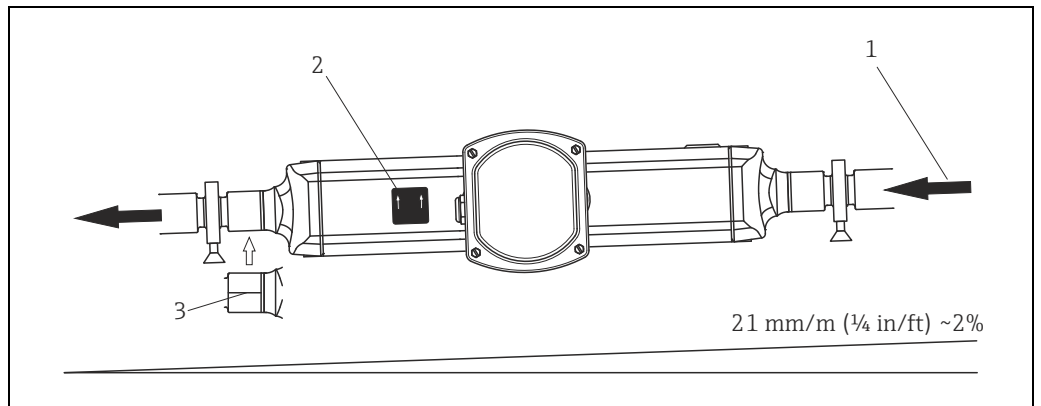

Fig. 10: Promass P: When lines are pitched in a specific direction and at a specific slope: as per hygienic guidelines (21 mm/m or approximately 2%). Gravity can be used to achieve complete drainability.

- 1 The arrow indicates the direction of flow (direction of fluid flow through the pipe).
- 2 The label shows the installation orientation for horizontal drainability.
- 3 The underside of the process connection is indicated by a scribed line. This line indicates the lowest point of the eccentric process connection.

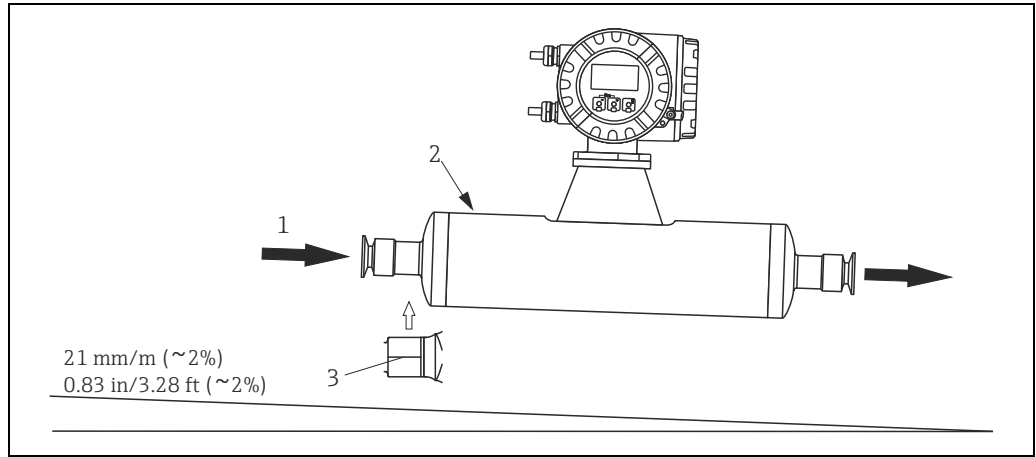

Fig. 11: Promass I: When lines are pitched in a specific direction and at a specific slope: as per hygienic guidelines (21 mm/m or approximately 2%). Gravity can be used to achieve complete drainability.

- 1 The arrow indicates the direction of flow (direction of fluid flow through the pipe).
- 2 The label shows the installation orientation for horizontal drainability.
- 3 The underside of the process connection is indicated by a scribed line. This line indicates the lowest point of the eccentric process connection.

**Promass I and P with hygienic connections  
(mounting clamp with lining between clamp and instrument)**

It is not necessary to support the sensor under any circumstances for operational performance. If the requirement exists to support the sensor the following recommendation should be followed.

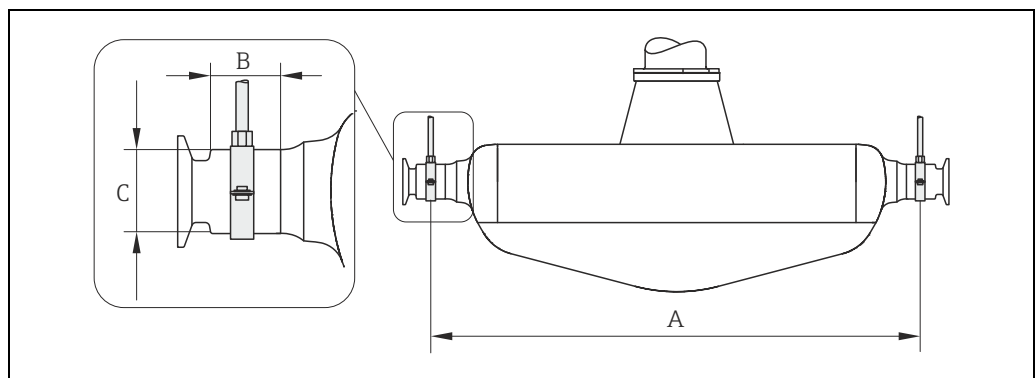

Fig. 12: Promass P, mounted with mounting clamp

DN	8	15	25	40	50
A	298	402	542	750	1019
B	33	33	33	36.5	44.1
C	28	28	38	56	75

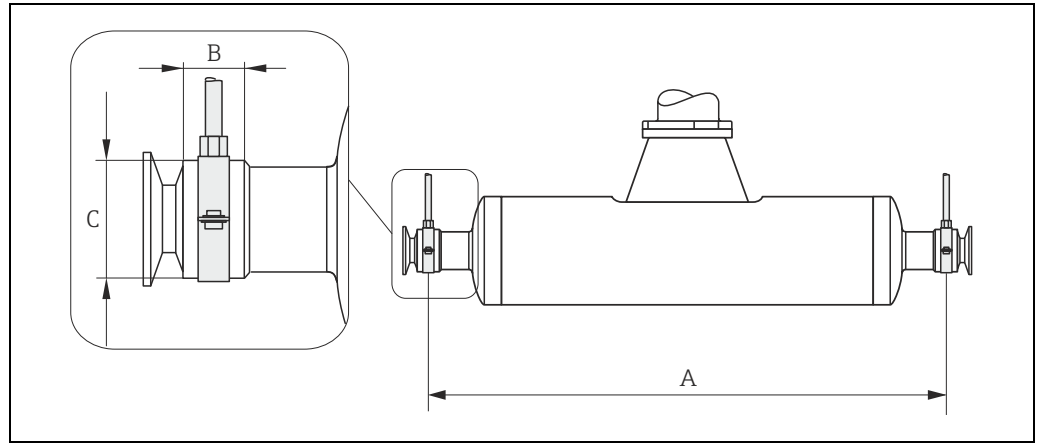

Fig. 13: Promass I, mounted with mounting clamp

DN	8	15	15FB	25	25FB	40	40FB	50	50FB	50FB	80	80
Tri-Clamp	½"	¾"	1"	1"	1 ½"	1 ½"	2"	2"	2 ½"	3"	2 ½"	3"
A	373	409	539	539	668	668	780	780	1152	1152	1152	1152
B	20	20	30	30	28	28	35	35	57	57	57	57
C	40	40	44.5	44.5	60	60	80	80	90	90	90	90

### Rupture disk

Sensor housings with integrated rupture disks are optionally available.

Make sure that the function and operation of the rupture disk is not impeded through the installation

of the device. The position of the rupture disk is indicated on a sticker beside it.

For additional information that is relevant to the process (→ 134).



Note!

- Please note that the housing can no longer assume a secondary containment function if a rupture disk is used.
- Rupture disks can not be combined with separately available heating jacket (except Promass A).
- The existing connection nozzles are not designed for a rinse or pressure monitoring function.
- It is not permitted to open the connections or remove the rupture disk.
- Before commissioning, please remove the transport protection of the rupture disk.
- The dimensions of the rupture disk are provided in the separate "Technical Information" document → 143.

### 3.2.5 Heating

Some fluids require suitable measures to avoid loss of heat at the sensor. Heating can be electric, e.g. with heated elements, or by means of hot water or steam pipes made of copper or heating jackets.



Caution!

- Risk of electronics overheating! Make sure that the maximum permissible ambient temperature for the transmitter is not exceeded. Consequently, make sure that the adapter between sensor and transmitter and the connection housing of the remote version always remain free of insulating material. Note that a certain orientation might be required, depending on the fluid temperature. → 15. For fluid temperature of 150°C (302°F) or above the usage of the remote version with separate connection housing is recommended.
- With a fluid temperature between 200 °C to 350 °C (392 to 662 °F) the remote version of the high-temperature version is preferable.

- When using electrical heat tracing whose heat is regulated using phase control or by pulse packs, it cannot be ruled out that the measured values are influenced by magnetic fields which may occur, (i.e. at values greater than those permitted by the EC standard (Sinus 30 A/m)). In such cases, the sensor must be magnetically shielded. The secondary containment can be shielded with tin plates or electric sheets without privileged direction (e.g. V330-35A) with the following properties:
  - Relative magnetic permeability  $\mu_r \geq 300$
  - Plate thickness  $d \geq 0.35 \text{ mm}$  (0.014")
- Information on permissible temperature ranges → ☰ 132
- Promass X: Especially under critical climatic conditions it has to be ensured that the temperature difference between environment and measured medium does not exceed 100 K. Suitable measures, such as heating or thermal insulation, are to be taken.

Special heating jackets which can be ordered as accessories from Endress+Hauser are available for the sensors.

### 3.2.6 Thermal insulation

Some fluids require suitable measures to avoid loss of heat at the sensor. A wide range of materials can be used to provide the required thermal insulation.

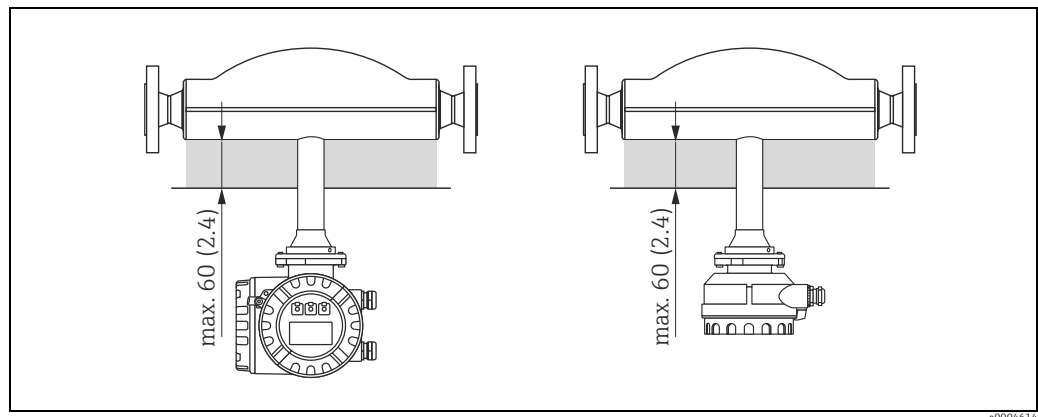

Fig. 14: In the case of the Promass F high-temperature version, a maximum insulation thickness of 60 mm (2.4") must be observed in the area of the electronics/neck.

If the Promass F high-temperature version is installed horizontally (with transmitter head pointing upwards), an insulation thickness of min. 10 mm (0.4") is recommended to reduce convection. The maximum insulation thickness of 60 mm (2.4") must be observed.

### 3.2.7 Inlet and outlet runs

There are no installation requirements regarding inlet and outlet runs. If possible, install the sensor well clear of fittings such as valves, T-pieces, elbows, etc.

### 3.2.8 Vibrations

The high oscillation frequency of the measuring tubes ensures that the correct operation of the measuring system is not influenced by pipe vibrations. Consequently, the sensors require no special measures for attachment.

### 3.2.9 Limiting flow

Relevant information can be found in the "Technical Data" section under "Measuring range" → ☰ 106 or "Limiting flow" → ☰ 134.

## 3.3 Installation

### 3.3.1 Turning the transmitter housing

#### Turning the aluminum field housing



##### Warning!

The turning mechanism in devices with EEx d/de or FM/CSA Cl. I Div. 1 classification is not the same as that described here. The procedure for turning these housings is described in the Ex-specific documentation.

1. Loosen the two securing screws.
2. Turn the bayonet catch as far as it will go.
3. Carefully lift the transmitter housing as far as it will go.
4. Turn the transmitter housing to the desired position (max.  $2 \times 90^\circ$  in either direction).
5. Lower the housing into position and reengage the bayonet catch.
6. Retighten the two securing screws.

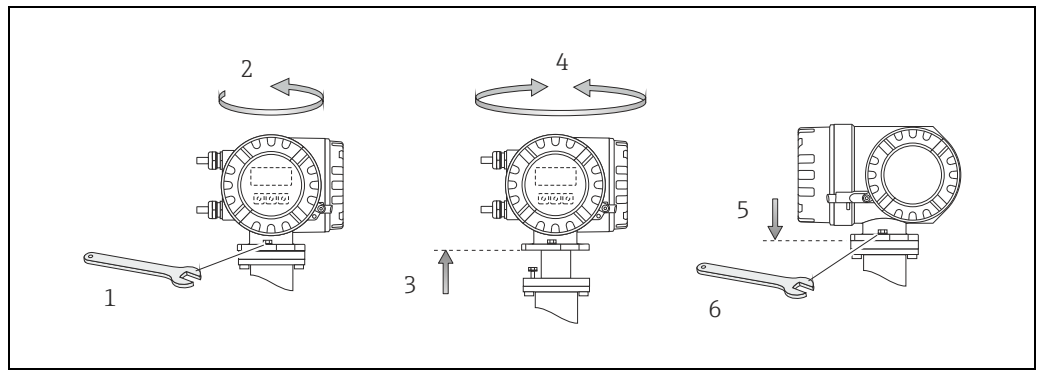

Fig. 15: Turning the transmitter housing (aluminum field housing)

#### Turning the stainless steel field housing

1. Loosen the two securing screws.
2. Carefully lift the transmitter housing as far as it will go.
3. Turn the transmitter housing to the desired position (max.  $2 \times 90^\circ$  in either direction).
4. Lower the housing into position.
5. Retighten the two securing screws.

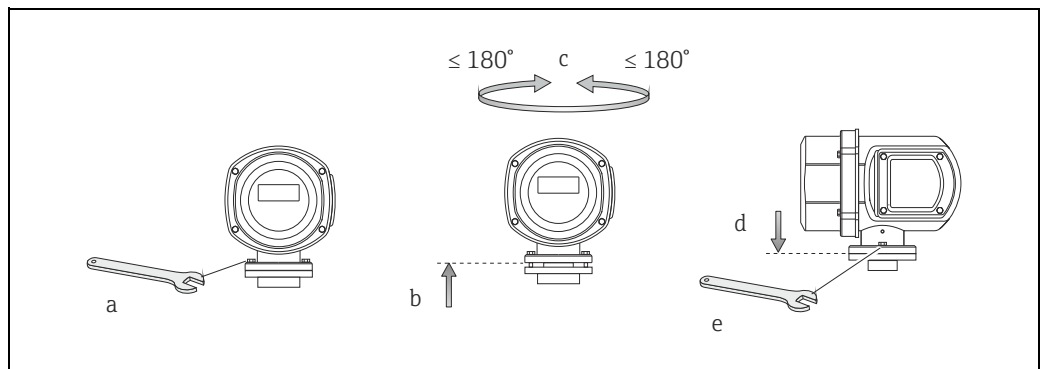

Fig. 16: Turning the transmitter housing (stainless steel field housing)

### 3.3.2 Installing the wall-mount housing

There are various ways of installing the wall-mount housing:

- Mounted directly on the wall
- Installation in control panel (separate mounting set, accessories) → 23
- Pipe mounting (separate mounting set, accessories) → 23



Caution!

- Make sure that ambient temperature does not go beyond the permissible range (-20 to +60 °C (-4 to +140 °F), optional -40 to +60 °C (-40 to +140 °F)). Install the device in a shady location. Avoid direct sunlight.
- Always install the wall-mount housing in such a way that the cable entries are pointing down.

#### Mounted directly on the wall

1. Drill the holes as illustrated in the diagram.
2. Remove the cover of the connection compartment (a).
3. Push the two securing screws (b) through the appropriate bores (c) in the housing.
  - Securing screws (M6): max. Ø 6.5 mm (0.26")
  - Screw head: max. Ø 10.5 mm (0.41")
4. Secure the transmitter housing to the wall as indicated.
5. Screw the cover of the connection compartment (a) firmly onto the housing.

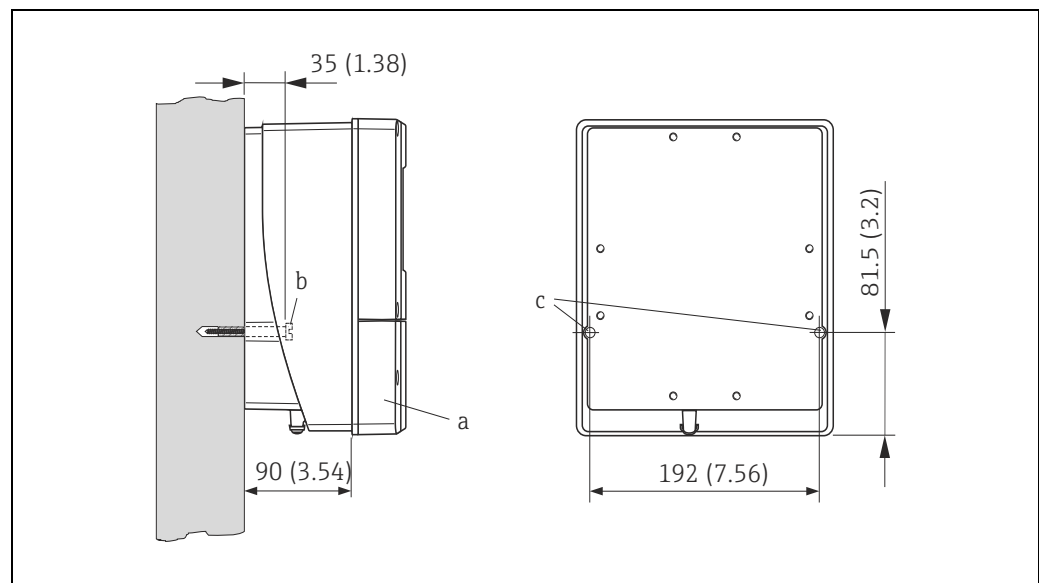

Fig. 17: Mounted directly on the wall

a0001130

### Installation in control panel

1. Prepare the opening in the panel as illustrated in the diagram.
2. Slide the housing into the opening in the panel from the front.
3. Screw the fasteners onto the wall-mount housing.
4. Screw threaded rods into holders and tighten until the housing is solidly seated on the panel wall. Afterwards, tighten the locking nuts. Additional support is not necessary.

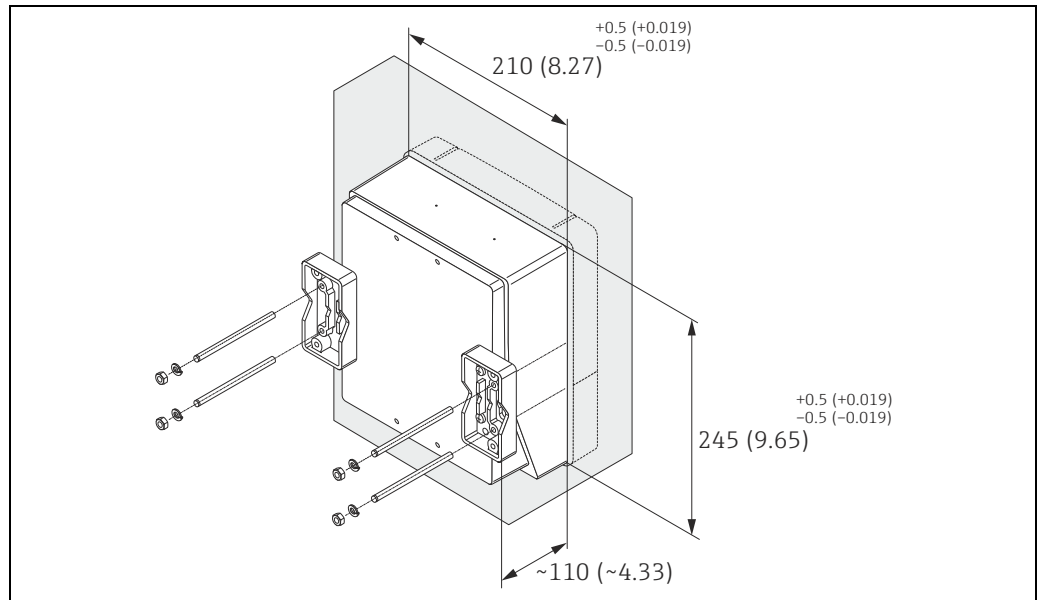

Fig. 18: Panel installation (wall-mount housing)

### Pipe mounting

The assembly should be performed by following the instructions in the diagram.



Caution!

If a warm pipe is used for installation, make sure that the housing temperature does not exceed the max. permitted value of +60 °C (+140 °F).

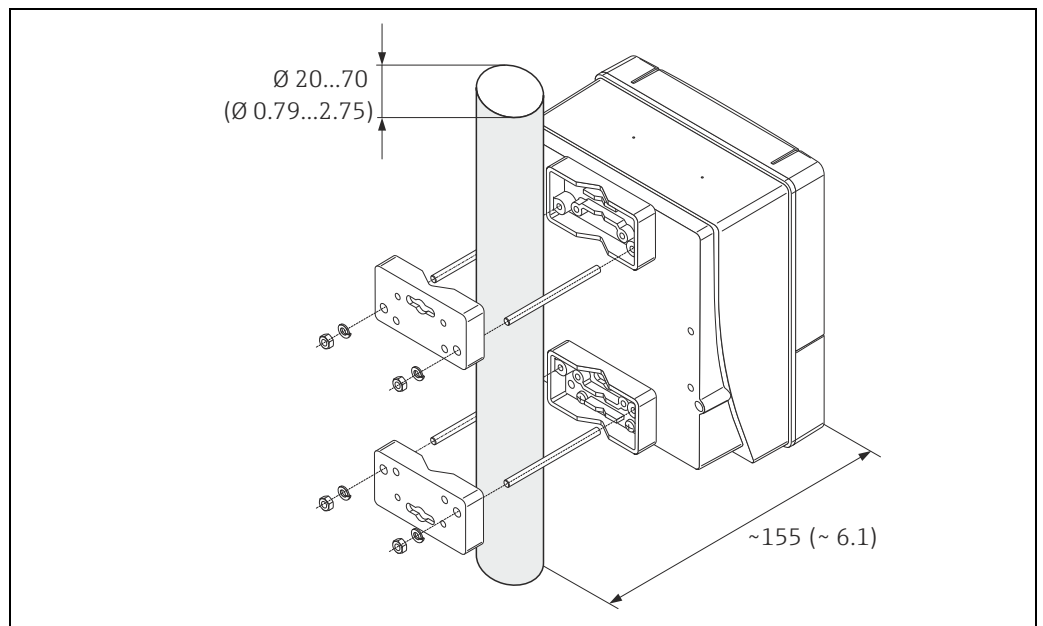

Fig. 19: Pipe mounting (wall-mount housing)

### 3.3.3 Turning the local display

1. Unscrew cover of the electronics compartment from the transmitter housing.
2. Press the side latches on the display module and remove the module from the electronics compartment cover plate.
3. Rotate the display to the desired position (max.  $4 \times 45^\circ$  in both directions), and reset it onto the electronics compartment cover plate.
4. Screw the cover of the electronics compartment firmly back onto the transmitter housing.

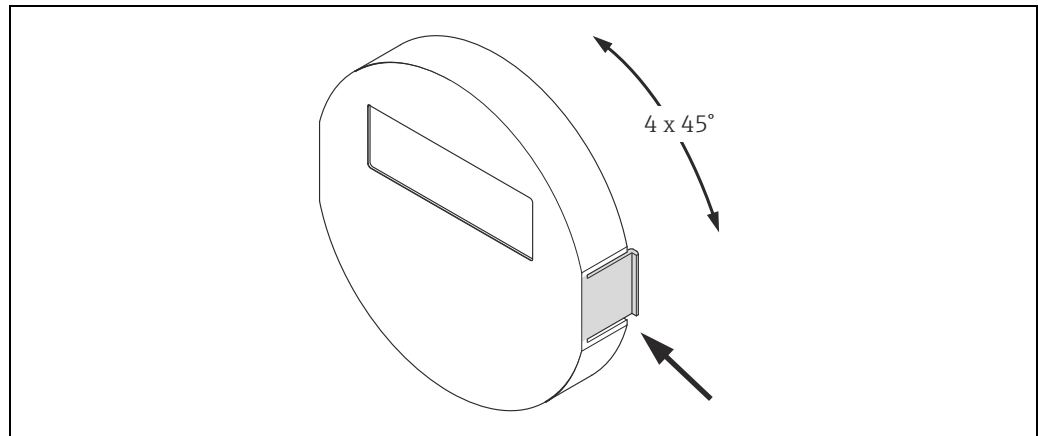

Fig. 20: Turning the local display (field housing)

### 3.4 Post-installation check

Perform the following checks after installing the measuring device in the pipe:

Device condition and specifications	Notes
Is the device damaged (visual inspection)?	-
Does the device correspond to specifications at the measuring point, including process temperature and pressure, ambient temperature, measuring range, etc.?	→ 4
Installation instructions	Notes
Does the arrow on the sensor nameplate match the direction of flow through the pipe?	-
Are the measuring point number and labeling correct (visual inspection)?	-
Is the orientation chosen for the sensor correct, in other words suitable for sensor type, fluid properties (outgassing, with entrained solids) and fluid temperature?	→ 13
Process environment / process conditions	Notes
Is the measuring device protected against moisture and direct sunlight?	-



## 4 Wiring



### Warning!

When connecting Ex-certified devices, see the notes and diagrams in the Ex-specific supplement to these Operating Instructions. Please do not hesitate to contact your Endress+Hauser sales office if you have any questions.



### Note!

The device does not have an internal power switch. For this reason, assign the device a switch or power-circuit breaker which can be used to disconnect the power supply line from the power grid.

### 4.1 Connecting the remote version

#### 4.1.1 Connecting connecting cable for sensor/transmitter



### Warning!

- Risk of electric shock. Switch off the power supply before opening the device. Do not install or wire the device while it is connected to the power supply. Failure to comply with this precaution can result in irreparable damage to the electronics.
- Risk of electric shock. Connect the protective ground to the ground terminal on the housing before the power supply is applied.
- You may only connect the sensor to the transmitter with the same serial number. Communication errors can occur if this is not observed when connecting the devices.

1. Remove the connection compartment cover (d) of the transmitter and sensor housing.
2. Feed the connecting cable (e) through the appropriate cable runs.
3. Establish the connections between sensor and transmitter in accordance with the wiring diagram (see → 21 or wiring diagram in screw cap).
4. Screw the connection compartment cover (d) back onto the sensor and transmitter housing.

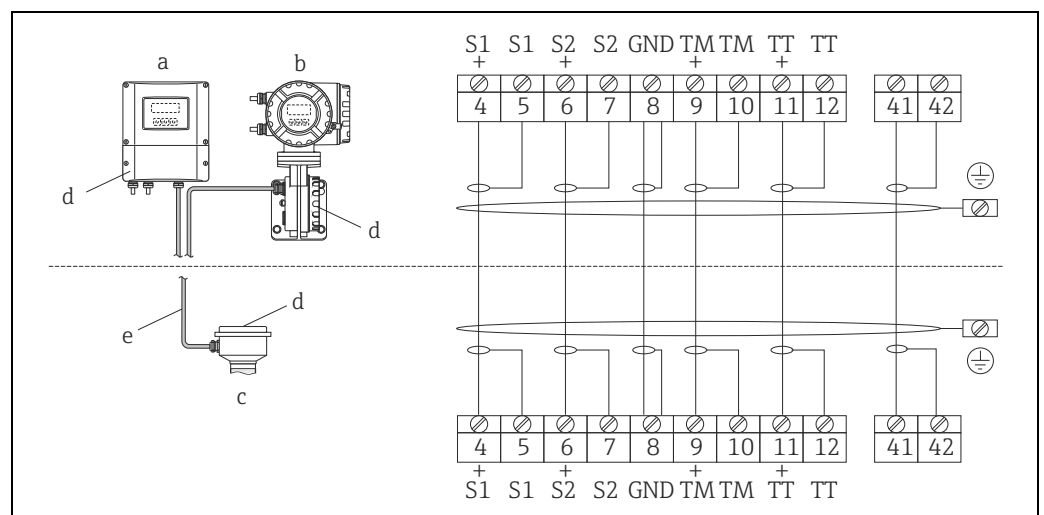

Fig. 21: Connecting the remote version

- a Wall-mount housing; non-hazardous area and ATEX II3G / zone 2 → see separate "Ex documentation"
- b Wall-mount housing; ATEX II2G / Zone 1 /FM/CSA → see separate "Ex documentation"
- c Remote version, flanged version
- d Cover of the connection compartment or connection housing
- e Connecting cable

Terminal No.: 4/5 = gray; 6/7 = green; 8 = yellow; 9/10 = pink; 11/12 = white; 41/42 = brown

### 4.1.2 Cable specification, connecting cable

The specifications of the cable connecting the transmitter and the sensor of the remote version are as follows:

- $6 \times 0.38 \text{ mm}^2$  PVC cable with common shield and individually shielded cores
- Conductor resistance:  $\leq 50 \text{ W/km}$
- Capacitance core/shield:  $\leq 420 \text{ pF/m}$
- Cable length: max. 20 m (65 ft)
- Permanent operating temperature: max.  $+105 \text{ }^\circ\text{C}$  ( $+221 \text{ }^\circ\text{F}$ )



Note!

The cable must be installed securely, to prevent movement.

## 4.2 Connecting the measuring unit

### 4.2.1 Transmitter connection



Warning!

- Risk of electric shock. Switch off the power supply before opening the device. Do not install or wire the device while it is connected to the power supply. Failure to comply with this precaution can result in irreparable damage to the electronics.
- Risk of electric shock. Connect the protective ground to the ground terminal on the housing before the power supply is applied (not required for galvanically isolated power supply).
- Compare the specifications on the nameplate with the local supply voltage and frequency. The national regulations governing the installation of electrical equipment also apply.

1. Unscrew the connection compartment cover (f) from the transmitter housing.
2. Feed the power supply cable (a) and the signal cable (b) through the appropriate cable entries.
3. Perform wiring:
  - Wiring diagram (aluminum housing) → 22
  - Wiring diagram (stainless steel housing) → 23
  - Wiring diagram (wall-mount housing) → 24
  - Terminal assignment → 28
4. Screw the cover of the connection compartment (f) back onto the transmitter housing.

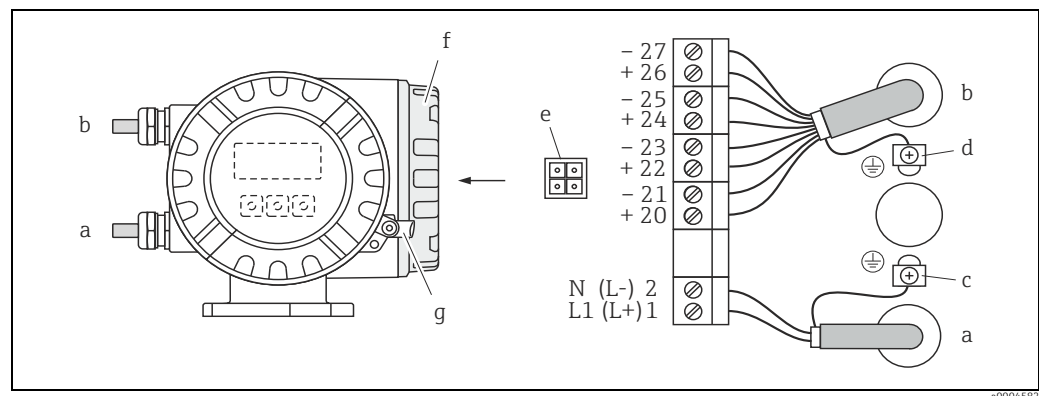

Fig. 22: Connecting the transmitter (aluminum field housing). Cable cross-section: max.  $2.5 \text{ mm}^2$

- a Cable for power supply: 85 to 260 V AC, 20 to 55 V AC, 16 to 62 V DC  
Terminal **No. 1:** L1 for AC, L+ for DC  
Terminal **No. 2:** N for AC, L- for DC
- b Signal cable: Terminals **Nos. 20-27** → 28
- c Ground terminal for protective ground
- d Ground terminal for signal cable shield
- e Service adapter for connecting service interface FXA193 (FieldCheck, FieldCare)
- f Cover of the connection compartment
- g Securing clamp

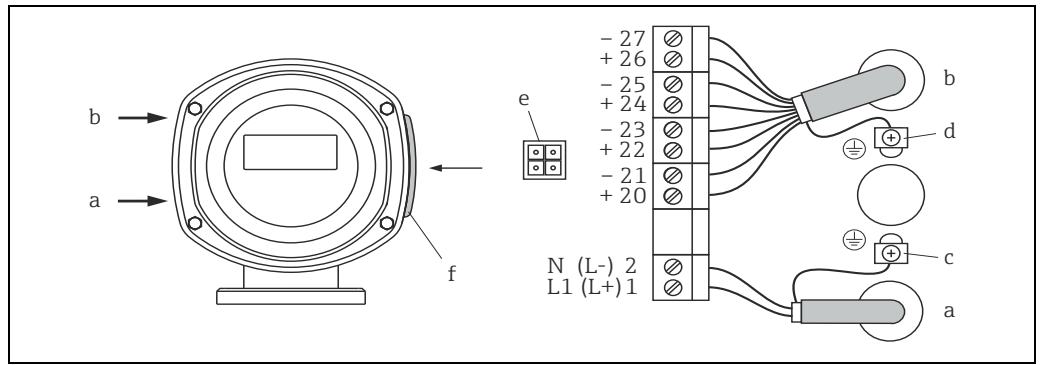

Fig. 23: Connecting the transmitter (stainless steel field housing); cable cross-section: max. 2.5 mm<sup>2</sup>

- a Cable for power supply: 85 to 260 V AC, 20 to 55 V AC, 16 to 62 V DC  
Terminal No. 1: L1 for AC, L+ for DC  
Terminal No. 2: N for AC, L- for DC
- b Signal cable: Terminals Nos. 20-27 → 28
- c Ground terminal for protective ground
- d Ground terminal for signal cable shield
- e Service adapter for connecting service interface FXA193 (FieldCheck, FieldCare)
- f Cover of the connection compartment

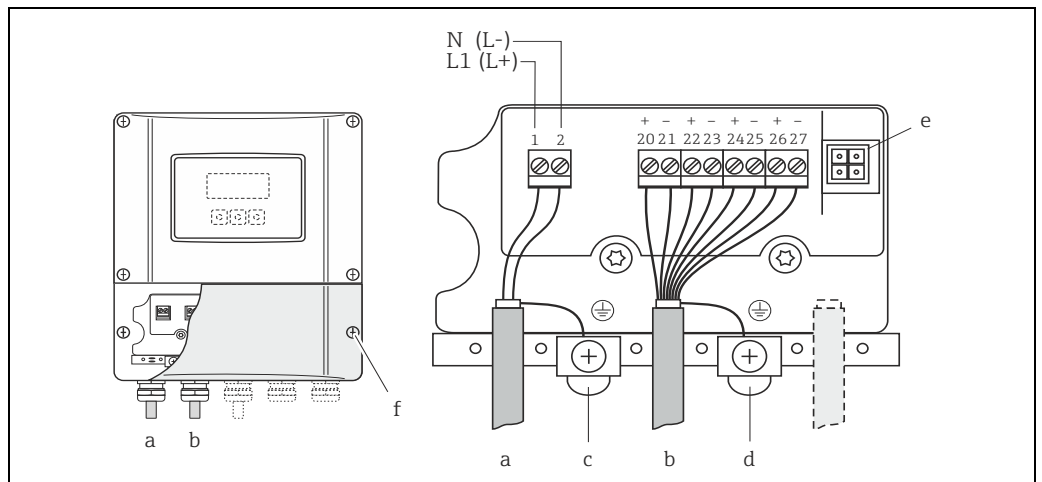

Fig. 24: Connecting the transmitter (wall-mount housing); cable cross-section: max. 2.5 mm<sup>2</sup>

- a Cable for power supply: 85 to 260 V AC, 20 to 55 V AC, 16 to 62 V DC  
Terminal No. 1: L1 for AC, L+ for DC  
Terminal No. 2: N for AC, L- for DC
- b Signal cable: Terminals Nos. 20-27 → 28
- c Ground terminal for protective ground
- d Ground terminal for signal cable shield
- e Service adapter for connecting service interface FXA193 (FieldCheck, FieldCare)
- f Cover of the connection compartment

## 4.2.2 Terminal assignment

Electrical values for:

- Inputs → 106
- Outputs → 109

Order characteristic for "inputs/outputs"	Terminal No. (inputs/outputs)			
	20 (+) / 21 (-)	22 (+) / 23 (-)	24 (+) / 25 (-)	26 (+) / 27 (-)
<i>Fixed communication boards (permanent assignment)</i>				
A	–	–	Frequency output	Current output, HART
B	Relay output	Relay output	Frequency output	Current output, HART
R	–	–	Current output 2, Ex i, active	Current output 1, Ex i, active, HART
S	–	–	Frequency output, Ex i, passive	Current output, Ex i, active, HART
T	–	–	Frequency output, Ex i, passive	Current output, Ex i, passive, HART
U	–	–	Current output 2, Ex i, passive	Current output 1, Ex i, passive, HART
<i>Flexible communication boards</i>				
C	Relay output 2	Relay output 1	Frequency output	Current output, HART
D	Status input	Relay output	Frequency output	Current output, HART
E	Status input	Relay output	Current output 2	Current output 1, HART
L	Status input	Relay output 2	Relay output 1	Current output, HART
M	Status input	Frequency output 2	Frequency output 1	Current output, HART
W	Relay output	Current output 3	Current output 2	Current output 1, HART
0	Status input	Current output 3	Current output 2	Current output 1, HART
2	Relay output	Current output 2	Frequency output	Current output 1, HART
3	Current input	Relay output	Current output 2	Current output 1, HART
4	Current input	Relay output	Frequency output	Current output, HART
5	Status input	Current input	Frequency output	Current output, HART
6	Status input	Current input	Current output 2	Current output, HART

### 4.2.3 HART connection

Users have the following connection options at their disposal:

- Direct connection to transmitter by means of terminals 26(+) / 27(-)
- Connection by means of the 4 to 20 mA circuit



Note!

- The measuring circuit's minimum load must be at least 250 W.
- The CURRENT SPAN function must be set to "4-20 mA" (individual options see device function).
- See also the documentation issued by the HART Communication Foundation, and in particular HCF LIT 20: "HART, a technical summary".

#### Connection of the HART handheld communicator

See also the documentation issued by the HART Communication Foundation, and in particular HCF LIT 20: "HART, a technical summary".

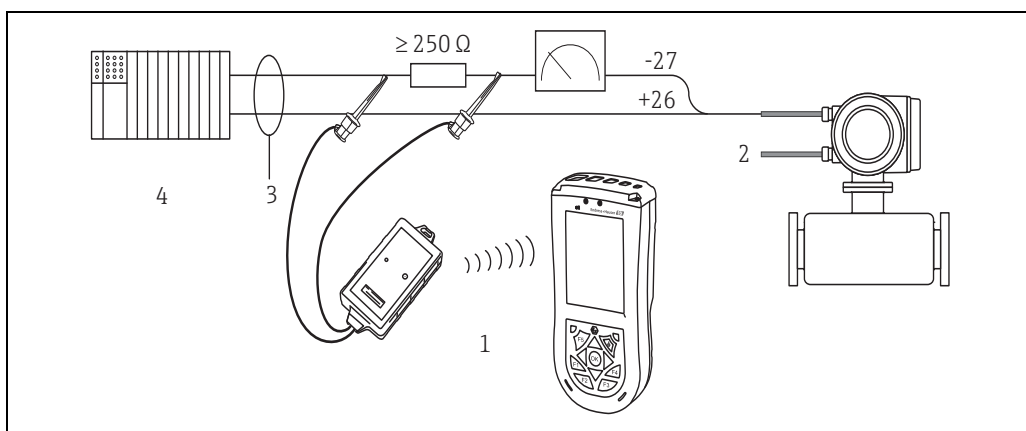

Fig. 25: Electrical connection of HART handheld Field Xpert SFX100

- 1 HART handheld Field Xpert SFX100
- 2 Auxiliary energy
- 3 Shielding
- 4 Other devices or PLC with passive input

#### Connection of a PC with an operating software

In order to connect a PC with operating software (e.g. FieldCare), a HART modem (e.g. Commubox FXA195) is needed.

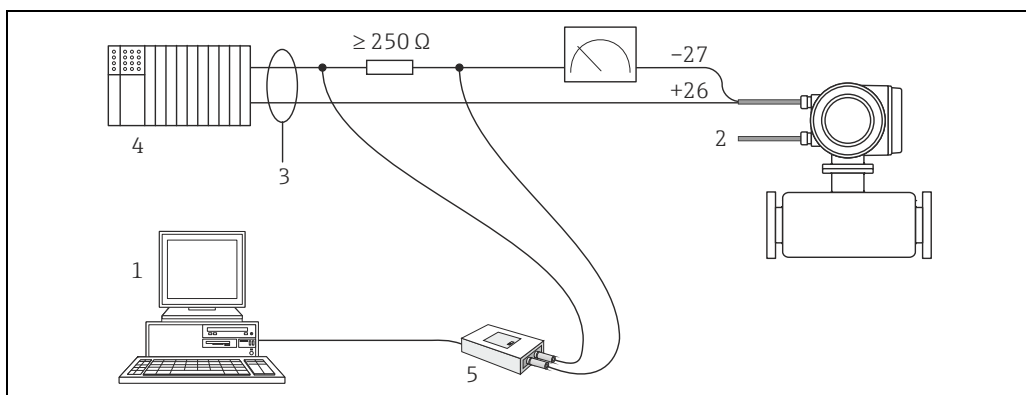





Fig. 26: Electrical connection of a PC with operating software

- 1 PC with operating software
- 2 Auxiliary energy
- 3 Shielding
- 4 Other switching units or PLC with passive input
- 5 HART modem, e.g. Commubox FXA195

## 4.3 Degree of protection

The measuring device fulfill all the requirements for IP 67.

Compliance with the following points is mandatory following installation in the field or servicing, in order to ensure that IP 67 protection is maintained:

- The housing seals must be clean and undamaged when inserted into their grooves. The seals must be dried, cleaned or replaced if necessary.
- The threaded fasteners and screw covers must be firmly tightened.
- The cables used for connection must be of the specified outside diameter →  110, cable entries.
- The cable entries must be firmly tighten (point **a** →  27).
- The cable must loop down in front of the cable entry ("water trap") (point **b** →  27). This arrangement prevents moisture penetrating the entry.

 Note!

The cable entries may not be point up.

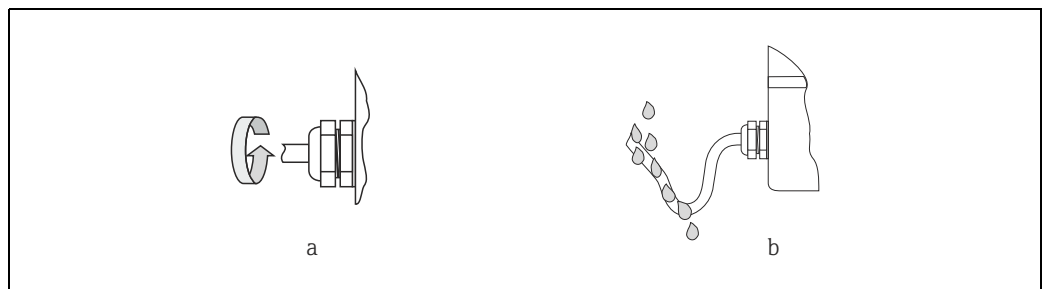

Fig. 27: Installation instructions, cable entries

- Remove all unused cable entries and insert plugs instead.
- Do not remove the grommet from the cable entry.





Caution!

Do not loosen the screws of the sensor housing, as otherwise the degree of protection guaranteed by Endress+Hauser no longer applies.

## 4.4 Post-connection check

Perform the following checks after completing electrical installation of the measuring device:

Device condition and specifications	Notes
Are cables or the device damaged (visual inspection)?	–
Electrical connection	Notes
Does the supply voltage match the specifications on the nameplate?	85 to 260 V AC (45 to 65 Hz) 20 to 55 V AC (45 to 65 Hz) 16 to 62 V DC
Do the cables comply with the specifications?	→  26
Do the cables have adequate strain relief?	–
Cables correctly segregated by type? Without loops and crossovers?	–
Are the power supply and signal cables correctly connected?	See the wiring diagram inside the cover of the terminal compartment
Are all screw terminals firmly tightened?	–
Are all cable entries installed, firmly tightened and correctly sealed? Cables looped as "water traps"?	→  30
Are all housing covers installed and firmly tightened?	–

## 5 Operation

### 5.1 Display and operating elements

The local display enables you to read all important parameters directly at the measuring point and configure the device using the "Quick Setup" or the function matrix. The display consists of four lines; this is where measured values and/or status variables (direction of flow, empty pipe, bar graph, etc.) are displayed. You can change the assignment of display lines to different variables to suit your needs and preferences (→ see the "Description of Device Functions" manual).

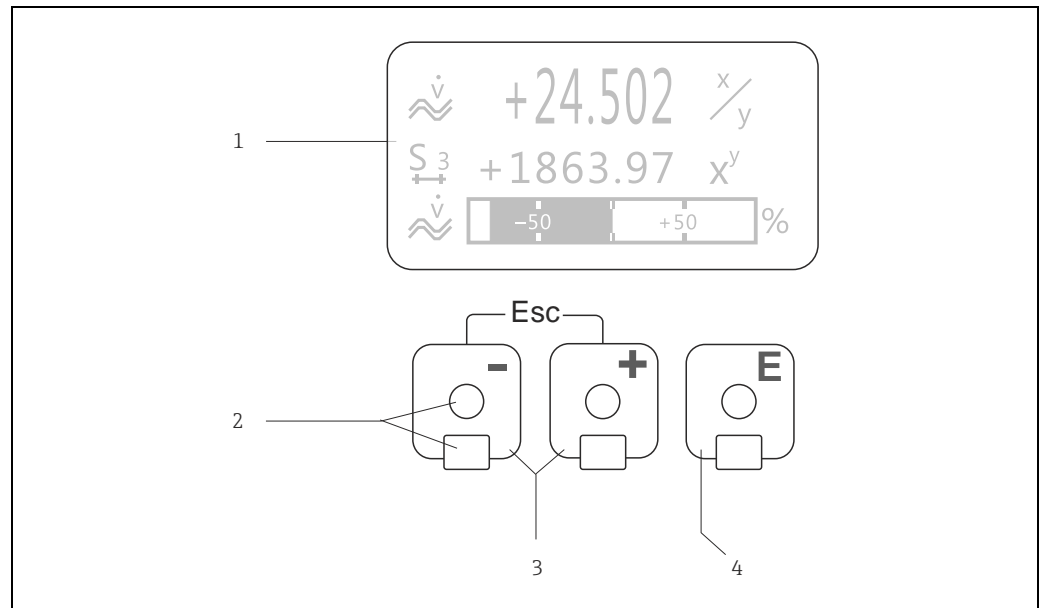

Fig. 28: Display and operating elements

- 1 **Liquid crystal display**  
The backlit, four-line liquid crystal display shows measured values, dialog texts, fault messages and notice messages. HOME position (operating mode) is the term given to the display during normal operation.  
Readings displayed
- 2 **Optical sensors for "Touch Control"**
- 3 **Plus/minus keys**
  - HOME position → Direct access to totalizer values and actual values of inputs/outputs
  - Enter numerical values, select parameters
  - Select different blocks, groups and function groups within the function matrix

Press the +/- keys (↵) simultaneously to trigger the following functions::

  - Exit the function matrix step by step → HOME position
  - Press and hold down +/- keys for longer than 3 seconds → Return directly to HOME position
  - Cancel data entry
- 4 **Enter key**
  - HOME position → Entry into the function matrix
  - Save the numerical values you input or settings you change

### 5.1.1 Readings displayed (operation mode)

The display area consists of three lines in all; this is where measured values are displayed, and/or status variables (direction of flow, bar graph, etc.). You can change the assignment of display lines to different variables to suit your needs and preferences (→ see the "Description of Device Functions" manual).

*Multiplex mode:*

A maximum of two different display variables can be assigned to each line. Variables multiplexed in this way alternate every 10 seconds on the display.

*Error messages:*

Display and presentation of system/process errors →  37

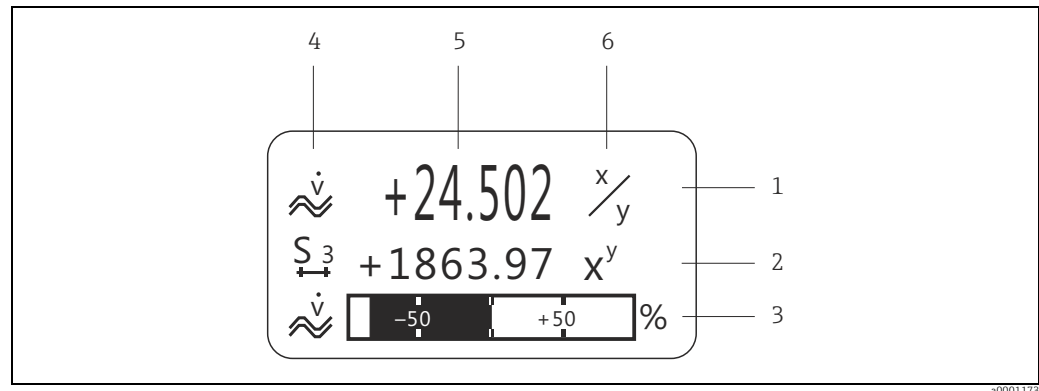



Fig. 29: Typical display for normal operating mode (HOME position)

- 1 Main line: shows main measured values
- 2 Additional line: shows additional measured variables and status variables
- 3 Information line: shows additional information on the measured variables and status variables, e.g. bargraph display
- 4 "Info icons" field: icons representing additional information on the measured values are shown in this field →  33.
- 5 "Measured values" field: the current measured values appear in this field.
- 6 "Unit of measure" field: the units of measure and time defined for the current measured values appear in this field.

### 5.1.2 Additional display functions

Depending on the order option, the local display has different display functions (F-CHIP →  83).

#### Device without batching software:

From HOME position, use the  keys to open an "Info Menu" containing the following information:

- Totalizer (including overflow)
- Actual values or states of the configured inputs/outputs
- Device TAG number (user-definable)

 → Scan of individual values within the Info Menu

 (Esc key) → Back to HOME position































#### Device with batching software:

On measuring instruments with installed batching software (F-Chip\*) and a suitably configured display line, you can carry out filling processes directly using the local display. You will find a detailed description →  34.



### 5.1.3 Icons

The icons which appear in the field on the left make it easier to read and recognize measured variables, device status, and error messages.

Icon	Meaning	Icon	Meaning
S	System error	P	Process error
	Fault message (with effect on outputs)	!	Notice message (without effect on outputs)
1 to n	Current output 1 to n	P 1 to n	Pulse output 1 to n
F 1 to n	Frequency output	S 1 to n	Status output/relay output 1 to n
S 1 to n	Totalizer 1 to n		Status input
	Measuring mode; PULSATING FLOW		Measuring mode; SYMMETRY (bidirectional)
	Measuring mode; STANDARD		Counting mode, totalizer; BALANCE (forward + reverse flow)
	Counting mode, totalizer; forward		Counting mode, totalizer; reverse
	Volume flow		Target volume flow
	Target corrected volume flow		Carrier volume flow
	Carrier corrected volume flow		% Target volume flow
	% Carrier volume flow		Mass flow
	Target mass flow		% Target mass flow
	Carrier mass flow		% Carrier mass flow
	Fluid density		Reference density
	Batching quantity upwards		Batching quantity downwards
	Batch quantity		Total batching quantity
	Batch counter (x times)		Fluid temperature
	Current input		Remote configuration Active device operation via: ▪ HART, e.g. FieldCare, DXR 375

### 5.1.4 Controlling the batching processes using the local display

Filling processes can be controlled directly by means of the local display with the aid of the optional "(Batching)" software package (F-CHIP, accessories → 85). Therefore, the device can be fully deployed in the field as a "batch controller".

Procedure:

1. Configure all the required batching functions and assign the lower display info line (= BATCHING KEYS) using the "Batch" Quick Setup menu (→ 62) or using the function matrix (→ 35).

The following "softkeys" then appear on the bottom line of the local display → 30:

- START = left display key (−)
- PRESET = middle display key (+)
- MATRIX = right display key (E)

2. Press the "PRESET (+)" key. Various batching process functions requiring configuration will now appear on the display:

"PRESET" → Initial settings for the batching process		
No.	Function	Configuration
7200	BATCH SELECTOR	⊕ ⊖ → Select the batching liquid (BATCH #1 to 6)
7203	BATCH QUANTITY	If the "ACCESS CUSTOMER" option was selected for the "PRESET batch quantity" prompt in the "Batching" Quick Setup, the batching quantity can be altered via the local display. If the "LOCKED" option was selected, the batching quantity can only be read and cannot be altered until the private code has been entered.
7265	RESET TOTAL BATCH SUM/ COUNTER	Resets the batching quantity counter or the total batching quantity to "0".

3. After exiting the PRESET menu, you can now start the batching process by pressing "START (−)". New softkeys (STOP / HOLD or GO ON) now appear on the display. You can use these to interrupt, continue or stop the batching process at any time. → 30

**STOP (−)** → Stops batching process

**HOLD (+)** → Interrupts batching process (softkey changes to "GO ON")

**GO ON (+)** → Continues batching process (softkey changes to "HOLD")

After the batch quantity is reached, the "START" or "PRESET" softkeys reappear on the display.

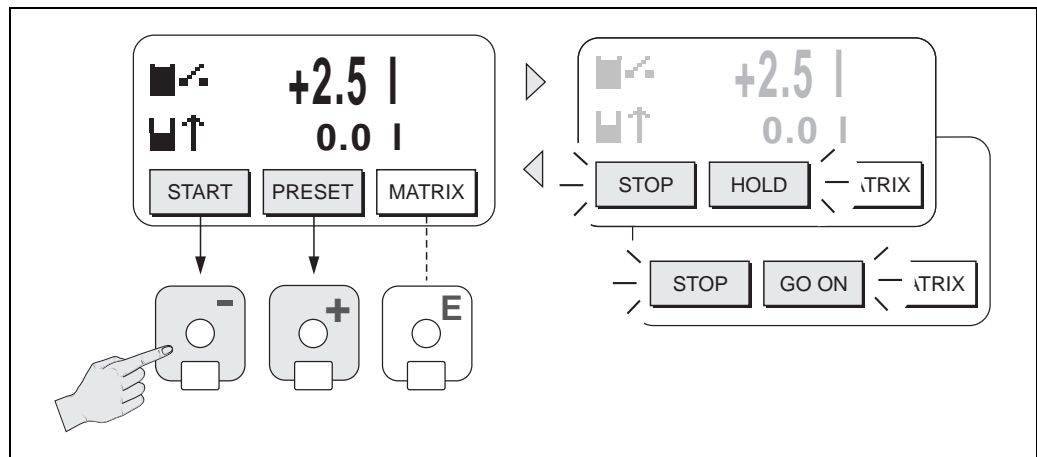

Fig. 30: Controlling batching processes using the local display (softkeys)

a0004386

## 5.2 Brief operating instructions to the function matrix



Note!

- See the general notes → 36
- Function descriptions → see the "Description of Device Functions" manual

1. HOME position → **E** → Entry into the function matrix
2. Select a block (e.g. OUTPUTS)
3. Select a group (e.g. CURRENT OUTPUT 1)
4. Select a function group (e.g. SETTINGS)
5. Select a function (e.g. TIME CONSTANT)  
Change parameter / enter numerical values:  
  - +** → Select or enter enable code, parameters, numerical values
  - E** → Save your entries
6. Exit the function matrix:
  - Press and hold down Esc key (**Esc**) for longer than 3 seconds → HOME position
  - Repeatedly press Esc key (**Esc**) → Return step by step to HOME position

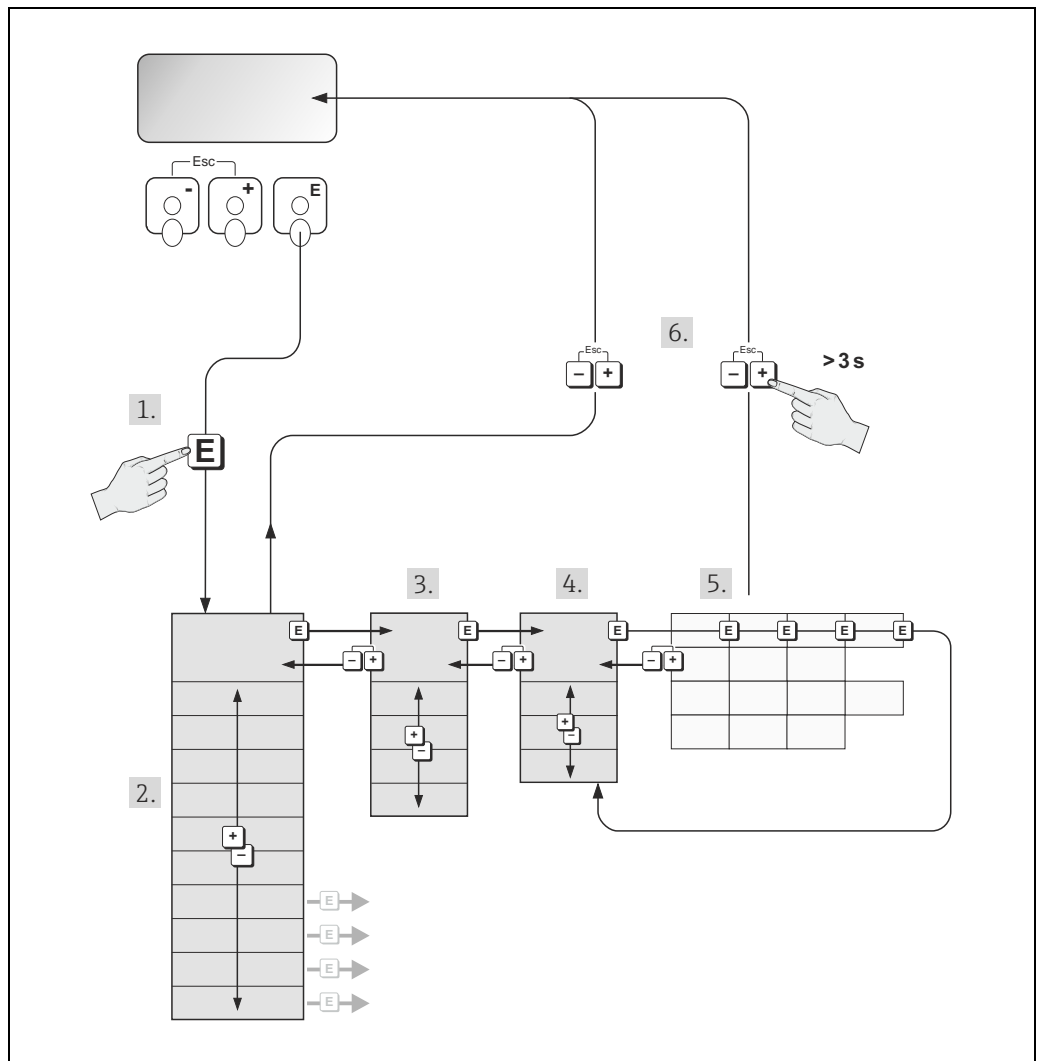





Fig. 31: Selecting functions and configuring parameters (function matrix)

a00012.10

### 5.2.1 General notes

The Quick Setup menu contains the default settings that are adequate for commissioning. Complex measuring operations on the other hand necessitate additional functions that you can configure as necessary and customize to suit your process parameters. The function matrix, therefore, comprises a multiplicity of additional functions which, for the sake of clarity, are arranged on a number of menu levels (blocks, groups, and function groups).

Comply with the following instructions when configuring functions:

- You select functions as described on →  35.
  - Each cell in the function matrix is identified by a numerical or letter code on the display.
- You can switch off certain functions (OFF). If you do so, related functions in other function groups will no longer be displayed.
- Certain functions prompt you to confirm your data entries. Press  to select "SURE | YES |" and press  to confirm. This saves your setting or starts a function, as applicable.
- Return to the HOME position is automatic if no key is pressed for 5 minutes.
- Programming mode is disabled automatically if you do not press a key within 60 seconds following automatic return to the HOME position.



Caution!

All functions are described in detail, as is the function matrix itself, in the "Description of Device Functions" manual, which is a separate part of these Operating Instructions.



Note!

- The transmitter continues to measure while data entry is in progress, i.e. the current measured values are output via the signal outputs in the normal way.
- If the supply voltage fails all preset and parameterized values remain safely stored in the EEPROM.

### 5.2.2 Enabling the programming mode

The function matrix can be disabled. Disabling the function matrix rules out the possibility of inadvertent changes to device functions, numerical values or factory settings. A numerical code (factory setting = 83) has to be entered before settings can be changed.

If you use a code number of your choice, you exclude the possibility of unauthorized persons accessing data (→ see the "Description of Device Functions" manual).

Comply with the following instructions when entering codes:

- If programming is disabled and the  operating elements are pressed in any function, a prompt for the code automatically appears on the display.
- If "0" is entered as the customer's code, programming is always enabled!
- The Endress+Hauser service organization can be of assistance if you mislay your personal code.



Caution!

Changing certain parameters such as all sensor characteristics, for example, influences numerous functions of the entire measuring system, particularly measuring accuracy. There is no need to change these parameters under normal circumstances and consequently, they are protected by a special code known only to the Endress+Hauser service organization. Please contact Endress+Hauser if you have any questions.

### 5.2.3 Disabling the programming mode

Programming mode is disabled if you do not press an operating element within 60 seconds following automatic return to the HOME position.

You can also disable programming in the ACCESS CODE function by entering any number (other than the customer's code).

## 5.3 Error messages

### 5.3.1 Type of error

Errors that occur during commissioning or measuring are displayed immediately. If two or more system or process errors are present, the error with the highest priority is the one shown on the display.

The measuring system distinguishes between two types of error:

- **System error:**  
Includes all device errors, e.g. communication errors, hardware errors, etc. → 88
- **Process error:**  
Includes all application errors, e.g. fluid not homogeneous, etc. → 93

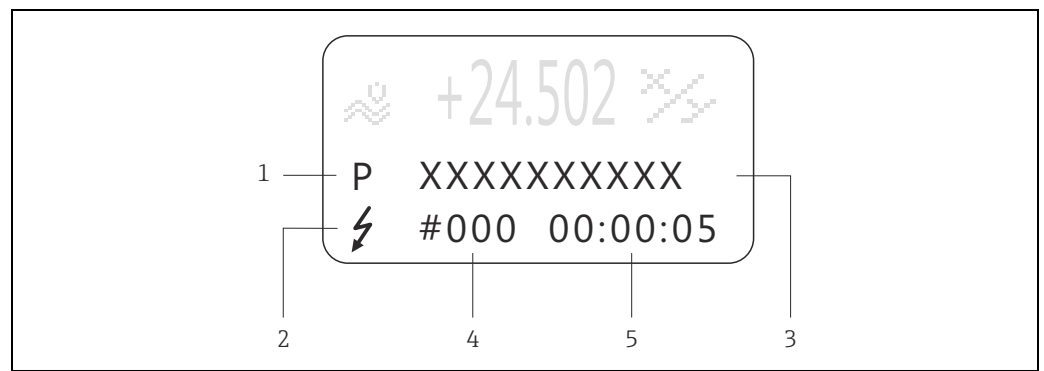

Fig. 32: Error messages on the display (example)

- 1 Error type: P = process error, S = system error
- 2 Error message type: ⚡ = fault message, ! = notice message
- 3 Error designation: e.g. "FLUID INHOM." = fluid is not homogeneous
- 4 Error number: e.g. #702
- 5 Duration of most recent error occurrence (hours: minutes: seconds)

### 5.3.2 Error message type

Users have the option of weighting system and process errors differently, by defining them as **Fault messages** or **Notice messages**. You can define messages in this way with the aid of the function matrix (see the "Description of Device Functions" manual).

Serious system errors, e.g. module defects, are always identified and classed as "fault messages" by the measuring device.

Notice message (!)

- The error in question has no effect on the current measuring operation and the outputs of the measuring device.
- Displayed as → Exclamation mark (!), type of error (S: system error, P: process error)

Fault message (⚡)

- The error in question interrupts or stops the current measuring operation and has an immediate effect on the outputs. The response of the outputs (failsafe mode) can be defined by means of functions in the function matrix. → 96
- Displayed as → Lightning flash (⚡), type of error (S: system error, P: process error)



Note!

- Error conditions can be output via the relay outputs.
- If an error message occurs, an upper or lower signal level for the breakdown information according to NAMUR 43 can be output via the current output.

### 5.3.3 Confirming error messages

For the sake of plant and process safety, the measuring device can be configured in such a way that fault messages displayed (⚡) always have to be rectified and acknowledged locally by pressing [E]. Only then do the error messages disappear from the display.

This option can be switched on or off by means of the "ACKNOWLEDGE FAULT MESSAGES" function (see the "Description of Device Functions" manual).



Note!

- Fault messages (⚡) can also be reset and confirmed via the status input.
- Notice messages (!) do not require acknowledgment. Note, however, that they remain visible until the cause of the error has been rectified.

## 5.4 Communication

In addition to local operation, the measuring device can be configured and measured values can be obtained by means of the HART protocol. Digital communication takes place using the 4-20 mA current output HART. → 29

The HART protocol allows the transfer of measuring and device data between the HART master and the field devices for configuration and diagnostics purposes. The HART master, e.g. a handheld terminal or PC-based operating programs (such as FieldCare), require device description (DD) files which are used to access all the information in a HART device.

Information is exclusively transferred using so-called "commands". There are three different command groups:

There are three different command groups:

- *Universal Commands*

Universal commands are supported and used by all HART devices. These are associated with the following functionalities for example:

- Recognizing HART devices
- Reading digital measured values (volume flow, totalizer, etc.)

- *Common practice commands:*

Common practice commands offer functions which are supported and can be executed by most but not all field devices.

- *Device-specific commands:*

These commands allow access to device-specific functions which are not HART standard. Such commands access individual field device information, amongst other things, such as empty/full pipe calibration values, low flow cut off settings, etc.



Note!

The measuring device has access to all three command classes.

### 5.4.1 Operating options

For the complete operation of the measuring device, including device-specific commands, there are DD files available to the user to provide the following operating aids and programs:



Note!

- In the CURRENT RANGE function (current output 1), the HART protocol demands the setting "4-20 mA HART" or "4-20 mA (25 mA) HART".
- HART write protection can be disabled or enabled by means of a jumper on the I/O board. → 55

#### HART handheld terminal Field Xpert

Selecting device functions with a HART Communicator is a process involving a number of menu levels and a special HART function matrix.

The HART manual in the carrying case of the HART Communicator contains more detailed information on the device.

**Operating program "FieldCare"**

FieldCare is Endress+Hauser's FDT-based plant asset management tool and allows the configuration and diagnosis of intelligent field devices. By using status information, you also have a simple but effective tool for monitoring devices. The Proline flowmeters are accessed via a HART interface FXA195 or via the service interface FXA193.

**Operating program "SIMATIC PDM" (Siemens)**

SIMATIC PDM is a standardized, manufacturer-independent tool for the operation, configuration, maintenance and diagnosis of intelligent field devices.

**Operating program "AMS" (Emerson Process Management)**

AMS (Asset Management Solutions): program for operating and configuring devices

**5.4.2 Current device description files**

The following table illustrates the suitable device description file for the operating tool in question and then indicates where these can be obtained.

HART protocol

Order code "Power Supply; Display", option A, B, C, D, E, F, G, H, X, 7, 8 (HART 5)		
<b>Valid for software:</b>	3.01.XX	→ Function DEVICE SOFTWARE (8100)
<b>Device data HART</b>		
Manufacturer ID:	11 <sub>hex</sub> (ENDRESS+HAUSER)	→ Function MANUFACTURER ID (6040)
Device ID:	51 <sub>hex</sub>	→ Function DEVICE ID (6041)
<b>HART version data:</b>	Device Revision 9 / DD Revision 1	
<b>Software release:</b>	01.2010	
<b>Operating program:</b>	<b>Sources for obtaining device descriptions:</b>	

Order code "Power Supply; Display", option P, Q, R, S, T, U, 4, 5 (HART 7)		
<b>Valid for software</b>	3.07.XX	→ Function DEVICE SOFTWARE (8100)
<b>Device data HART</b>		
Manufacturer ID:	11 <sub>hex</sub> (ENDRESS+HAUSER)	→ Function MANUFACTURER ID (6040)
Device ID:	51 <sub>hex</sub>	→ Function DEVICE ID (6041)
<b>HART version data</b>	Device Revision 9 / DD Revision 1	
<b>Software release</b>	12.2014	

Field Xpert handheld terminal	<ul style="list-style-type: none"> <li>Use update function of handheld terminal</li> </ul>
FieldCare / DTM	<ul style="list-style-type: none"> <li>www.endress.com → Download-Area</li> <li>CD-ROM (Endress+Hauser order number 56004088)</li> <li>DVD (Endress+Hauser order number 70100690)</li> </ul>
AMS	<ul style="list-style-type: none"> <li>www.endress.com → Download-Area</li> </ul>
SIMATIC PDM	<ul style="list-style-type: none"> <li>www.endress.com → Download-Area</li> </ul>

<b>Tester/simulator:</b>	<b>Sources for obtaining device descriptions:</b>
Fieldcheck	<ul style="list-style-type: none"> <li>Update by means of FieldCare via flow device FXA 193/291 DTM in Fieldflash Module</li> </ul>

### 5.4.3 Device and process variables

*Device variables:*

The following device variables are available using the HART protocol:

Code (decimal)	Device variable	Code (decimal)	Device variable
0	OFF (unassigned)	26	°PLATO
2	Mass flow	27	°BALLING
5	Volume flow	28	°BRIX
6	Corrected volume flow	29	Other
7	Density	52	Batch up
8	Reference density	53	Batch down
9	Temperature	58	Mass flow deviation
12	Target mass flow	59	Density deviation
13	% Target mass flow	60	Reference density deviation
14	Target volume flow	61	Temperature deviation
15	% Target volume flow	62	Tube damping deviation
16	Target corrected volume flow	63	Electrodyn. sensor deviation
17	Carrier mass flow	64	Dynamic viscosity
18	% Carrier mass flow	65	Kinematic viscosity
19	Carrier volume flow	81	Temp. comp. dyn. viscosity
20	% carrier volume flow	82	Temp. comp. kin. viscosity
21	Carrier corrected volume flow	86	Operating frequency fluctuation
22	%-BLACK LIQUOR	87	Tube damping fluctuation
23	°BAUME >1kg/l	250	Totalizer 1
24	°BAUME <1kg/l	251	Totalizer 2
25	°API	252	Totalizer 3

*Process variables:*

At the factory, the process variables are assigned to the following device variables:

- Primary process variable (PV) → Mass flow
- Second process variable (SV) → Totalizer 1
- Third process variable (TV) → Density
- Fourth process variable (FV) → Temperature





Note!

You can set or change the assignment of device variables to process variables using Command 51.







### 5.4.4 Universal / Common practice HART commands

The following table contains all the universal commands supported by the device.







Command No. HART command / Access type		Command data (numeric data in decimal form)	Response data (numeric data in decimal form)
<b>Universal Commands</b>			
0 (HART 5)	Read unique device identifier Access type = read	none	<p>Device identification delivers information on the device and the manufacturer. It cannot be changed.</p> <p>The response consists of a 12-byte device ID:</p> <ul style="list-style-type: none"> <li>- Byte 0: Fixed value 254</li> <li>- Byte 1: Manufacturer ID, 17 = E+H</li> <li>- Byte 2: Device type ID, e.g. 81 = Promass 83 or 80 = Promass 80</li> <li>- Byte 3: Number of preambles</li> <li>- Byte 4: Universal commands rev. no.</li> <li>- Byte 5: Device-spec. commands rev. no.</li> <li>- Byte 6: Software revision</li> <li>- Byte 7: Hardware revision</li> <li>- Byte 8: Additional device information</li> <li>- Byte 9-11: Device identification</li> </ul>
0 (HART 7)	Read unique device identifier Access type = read	none	<p>Device identification delivers information on the device and the manufacturer. It cannot be changed.</p> <p>The response consists of a 22 byte device ID:</p> <ul style="list-style-type: none"> <li>- Byte 0: Fixed value 254</li> <li>- Byte 1: Manufacturer ID, 17 = E+H</li> <li>- Byte 2: Device type ID, e.g.66 = Promag 53</li> <li>- Byte 3: Number of preambles</li> <li>- Byte 4: Universal commands rev. no.</li> <li>- Byte 5: Device-specific rev. no. Commands</li> <li>- Byte 6: Software revision</li> <li>- Byte 7: Hardware revision</li> <li>- Byte 8: Additional device information</li> <li>- Byte 9-11: Device identification</li> <li>- Byte 12: Minimum number of preambles that are sent by the slave to the master with the response message</li> <li>- Byte 13: Maximum number of device variables</li> <li>- Byte 14-15: Configuration change counter</li> <li>- Byte 16: Extended field device status</li> <li>- Byte 17-18: Manufacturer ID code</li> </ul>
1	Read primary process variable Access type = read	none	<ul style="list-style-type: none"> <li>- Byte 0: HART unit code of the primary process variable</li> <li>- Bytes 1-4: Primary process variable</li> </ul> <p><i>Factory setting:</i> Primary process variable = Mass flow</p> <p> <b>Note!</b></p> <ul style="list-style-type: none"> <li>■ You can set the assignment of device variables to process variables using Command 51.</li> <li>■ Manufacturer-specific units are represented using the HART unit code "240".</li> </ul>
2	Read the primary process variable as current in mA and percentage of the set measuring range Access type = read	none	<ul style="list-style-type: none"> <li>- Bytes 0-3: Actual current of the primary process variable in mA</li> <li>- Bytes 4-7: Percentage of the set measuring range</li> </ul> <p><i>Factory setting:</i> Primary process variable = Mass flow</p> <p> <b>Note!</b> You can set the assignment of device variables to process variables using Command 51.</p>





Command No. HART command / Access type		Command data (numeric data in decimal form)	Response data (numeric data in decimal form)															
3	Read the primary process variable as current in mA and four (preset using Command 51) dynamic process variables Access type = read	none	<p>24 bytes are sent as a response:</p> <ul style="list-style-type: none"> <li>- Bytes 0-3: Primary process variable current in mA</li> <li>- Byte 4: HART unit code of the primary process variable</li> <li>- Bytes 5-8: Primary process variable</li> <li>- Byte 9: HART unit code of the second process variable</li> <li>- Bytes 10-13: Second process variable</li> <li>- Byte 14: HART unit code of the third process variable</li> <li>- Bytes 15-18: Third process variable</li> <li>- Byte 19: HART unit code of the fourth process variable</li> <li>- Bytes 20-23: Fourth process variable</li> </ul> <p><i>Factory setting:</i></p> <ul style="list-style-type: none"> <li>■ Primary process variable = Mass flow</li> <li>■ Second process variable = Totalizer 1</li> <li>■ Third process variable = Density</li> <li>■ Fourth process variable = Temperature</li> </ul> <p> Note!</p> <ul style="list-style-type: none"> <li>■ You can set the assignment of device variables to process variables using Command 51.</li> <li>■ Manufacturer-specific units are represented using the HART unit code "240".</li> </ul>															
6 (HART 5)	Set HART shortform address Access type = write	<p>Byte 0: desired address (0 to 15)</p> <p><i>Factory setting:</i> 0</p> <p> Note! With an address &gt;0 (multidrop mode), the current output of the primary process variable is set to 4 mA.</p>	Byte 0: active address															
6 (HART 7)	Set HART address and loop current mode Access type = write	<p>Byte 0: Desired address (0 to 63)</p> <p><i>Factory setting:</i> 0</p> <p> Note! With an address &gt;0 (multidrop mode), the current output of the primary process variable is fixed at 4 mA..</p>	<p>Byte 0: Active address</p> <p>Byte 1: Loop current mode</p>															
9 (HART 7)	Write long HART tag name Access type = write	none	<p>This command allows a master (PLC) to request the value and status of up to four devices or dynamic variables..</p> <table border="1" style="width: 100%; border-collapse: collapse;"> <thead> <tr> <th>Number of device variables requested</th> <th>Number of data bytes requested</th> <th>Number of data bytes in response</th> </tr> </thead> <tbody> <tr> <td>1</td> <td>1</td> <td>9</td> </tr> <tr> <td>2</td> <td>2</td> <td>17</td> </tr> <tr> <td>3</td> <td>3</td> <td>25</td> </tr> <tr> <td>4</td> <td>4</td> <td>33</td> </tr> </tbody> </table>	Number of device variables requested	Number of data bytes requested	Number of data bytes in response	1	1	9	2	2	17	3	3	25	4	4	33
Number of device variables requested	Number of data bytes requested	Number of data bytes in response																
1	1	9																
2	2	17																
3	3	25																
4	4	33																



Command No. HART command / Access type		Command data (numeric data in decimal form)	Response data (numeric data in decimal form)
11	Read unique device identification using the TAG (measuring point designation) Access type = read	Bytes 0-5: TAG	Device identification delivers information on the device and the manufacturer. It cannot be changed. The response consists of a 12-byte device ID if the given TAG agrees with the one saved in the device: <ul style="list-style-type: none"> <li>- Byte 0: Fixed value 254</li> <li>- Byte 1: Manufacturer ID, 17 = E+H</li> <li>- Byte 2: Device type ID, 81 = Promass 83 or 80 = Promass 80</li> <li>- Byte 3: Number of preambles</li> <li>- Byte 4: Universal commands rev. no.</li> <li>- Byte 5: Device-spec. commands rev. no.</li> <li>- Byte 6: Software revision</li> <li>- Byte 7: Hardware revision</li> <li>- Byte 8: Additional device information</li> <li>- Byte 9-11: Device identification</li> </ul>
12	Read user message Access type = read	none	Bytes 0-24: User message  Note! You can write the user message using Command 17.
13	Read TAG, descriptor and date Access type = read	none	- Byte 0-5: TAG - Bytes 6-17: Descriptor - Byte 18-20: Date  Note! You can write the TAG, descriptor and date using Command 18.
14	Read sensor information on primary process variable	none	- Bytes 0-2: Sensor serial number - Byte 3: HART unit code of sensor limits and measuring range of the primary process variable - Bytes 4-7: Upper sensor limit - Bytes 8-11: Lower sensor limit - Bytes 12-15: Minimum span  Note! <ul style="list-style-type: none"> <li>■ The data relate to the primary process variable (= Mass flow).</li> <li>■ Manufacturer-specific units are represented using the HART unit code "240".</li> </ul>
15	Read output information of primary process variable Access type = read	none	- Byte 0: Alarm selection ID - Byte 1: Transfer function ID - Byte 2: HART unit code for the set measuring range of the primary process variable - Bytes 3-6: Upper range, value for 20 mA - Bytes 7-10: Start of measuring range, value for 4 mA - Bytes 11-14: Attenuation constant in [s] - Byte 15: Write protection ID - Byte 16: OEM dealer ID, 17 = E+H  <i>Factory setting:</i> Primary process variable = Mass flow  Note! <ul style="list-style-type: none"> <li>■ You can set the assignment of device variables to process variables using Command 51.</li> <li>■ Manufacturer-specific units are represented using the HART unit code "240".</li> </ul>
16	@Read the device production number Access type = read	none	Bytes 0-2: Production number
17	Write user message Access = write	You can save any 32-character long text in the device under this parameter: Bytes 0-23: Desired user message	Displays the current user message in the device: Bytes 0-23: Current user message in the device

Command No. HART command / Access type		Command data (numeric data in decimal form)	Response data (numeric data in decimal form)		
18	Write TAG, descriptor and date Access = write	With this parameter, you can store an 8 character TAG, a 16 character descriptor and a date: - Bytes 0-5: TAG - Bytes 6-17: Descriptor - Byte 18-20: Date	Displays the current information in the device: - Bytes 0-5: TAG - Bytes 6-17: Descriptor - Byte 18-20: Date		
20 (HART 7)	Read long HART tag name Access type = read	none	The long tag name with the international character set (ISO Latin 1) makes it possible to use longer names as required by many users in industry. The long tag name occupies 16 consecutive buffer memory addresses. 32 characters are saved in ASCII format, the first character in the least significant byte (LSB) of the lowest buffer memory address.		
21 (HART 7)	Read unique ID assigned to long HART tag name Access type = read	none	This command can either be issued with the long frame address of the device or the broadcast address No response if the long HART tag name and the device do not match. This comparison is case-sensitive. If the long frame address is used, no response if the address and the long HART tag name of the device do not match		
22 (HART 7)	Write long HART tag name Access type = write	Byte 0-31: Long HART tag name response codes	Response codes		
			Code	Class	Description
			0	Success	No command-specific errors
			1-4		Undefined
			5	Error	Too few data bytes received
			6	Error	Device-specific command error
			7	Error	In write protect mode
			8-15		Undefined
			16	Error	Access Restricted
			17-31		Undefined
			32	Error	Busy (A DR cannot be started)
			33	Error	DR Initiated
34	Error	DR Running			
35	Error	DR Dead			
36	Error	DR Conflict			

The following table contains all the common practice commands supported by the device.

Command No. HART command / Access type	Command data (numeric data in decimal form)	Response data (numeric data in decimal form)
<b>Common Practice Commands")</b>		
34	Write damping value for primary process variable Access = write  <i>Factory setting:</i> Primary process variable = Mass flow	Displays the current damping value in the device: Bytes 0-3: Damping value in seconds
35	Write measuring range of primary process variable Access = write  <i>Factory setting:</i> Primary process variable = Mass flow  Note! <ul style="list-style-type: none"> <li>▪ Die You can set the assignment of device variables to process variables using Command 51.</li> <li>▪ If the HART unit code is not the correct one for the process variable, the device will continue with the last valid unit.</li> </ul>	The currently set measuring range is displayed as a response: <ul style="list-style-type: none"> <li>- Byte 0: HART unit code for the set measuring range of the primary process variable</li> <li>- Bytes 1-4: Upper range, value for 20 mA</li> <li>- Bytes 5-8: Start of measuring range, value for 4 mA</li> </ul>  Note! Manufacturer-specific units are represented using the HART unit code "240".
38	Device status reset (Configuration changed) Access = write	none
40	Simulate output current of primary process variable Access = write  <i>Factory setting:</i> Primary process variable = Mass flow  Note! You can set the assignment of device variables to process variables with Command 51.	The momentary output current of the primary process variable is displayed as a response: Byte 0-3: Output current in mA
42	Perform master reset Access = write	none
44	Write unit of primary process variable Access = write  <i>Factory setting:</i> Primary process variable = Mass flow  Note! <ul style="list-style-type: none"> <li>▪ If the written HART unit code is not the correct one for the process variable, the device will continue with the last valid unit.</li> <li>▪ If you change the unit of the primary process variable, this has no impact on the system units.</li> </ul>	The current unit code of the primary process variable is displayed as a response: Byte 0: HART unit code  Note! Manufacturer-specific units are represented using the HART unit code "240".
48	Read additional device status Access = read	none  The device status is displayed in extended form as the response: Coding: see table →  49

Command No. HART command / Access type	Command data (numeric data in decimal form)	Response data (numeric data in decimal form)
50 Read assignment of the device variables to the four process variables Access = read	none	Display of the current variable assignment of the process variables: – Byte 0: Device variable code to the primary process variable – Byte 1: Device variable code to the second process variable – Byte 2: Device variable code to the third process variable – Byte 3: Device variable code to the fourth process variable  <i>Factory setting:</i> ■ Primary process variable: Code 1 for mass flow ■ Second process variable: Code 250 for totalizer 1 ■ Third process variable: Code 7 for density ■ Fourth process variable: Code 9 for temperature   <b>Note!</b> You can set the assignment of device variables to process variables with Command 51.
51 Write assignments of the device variables to the four process variables Access = write	Setting of the device variables to the four process variables: – Byte 0: Device variable code to the primary process variable – Byte 1: Device variable code to the second process variable – Byte 2: Device variable code to the third process variable – Byte 3: Device variable code to the fourth process variable  <i>Code of the supported device variables:</i> See data →  40  <i>Factory setting:</i> ■ Primary process variable = Mass flow ■ Second process variable = Totalizer 1 ■ Third process variable = Density ■ Fourth process variable = Temperature	The variable assignment of the process variables is displayed as a response: – Byte 0: Device variable code to the primary process variable – Byte 1: Device variable code to the second process variable – Byte 2: Device variable code to the third process variable – Byte 3: Device variable code to the fourth process variable
53 Write device variable unit Access = write	This command sets the unit of the given device variables. Only those units which suit the device variable are transferred: – Byte 0: Device variable code – Byte 1: HART unit code  <i>Code of the supported device variables:</i> See data →  40   <b>Note!</b> ■ If the written unit is not the correct one for the device variable, the device will continue with the last valid unit. ■ If you change the unit of the device variable, this has no impact on the system units.	The current unit of the device variables is displayed in the device as a response: – Byte 0: Device variable code – Byte 1: HART unit code   <b>Note!</b> Manufacturer-specific units are represented using the HART unit code "240".
59 Write number of preambles in response message Access = write	This parameter sets the number of preambles which are inserted in the response messages: Byte 0: Number of preambles (2 to 20)	As a response, the current number of the preambles is displayed in the response message: Byte 0: Number of preambles
95 (HART 7) Read device communication statistics Access type = read	none	The device communication statistics command provides statistics about device communication  6 bytes follow by way of response – Byte 0-1: Number of STX messages received by the device – Byte 2-3: Number of ACK messages sent by the device – Byte 4-6: Number of BACK messages sent by the device

Command No. HART command / Access type		Command data (numeric data in decimal form)	Response data (numeric data in decimal form)
523 (HART 7)	Read condensed status mapping array Access type = read	Byte 0: Start index of the status map Byte 1: Number of status map entries to be read	<p>This command returns the requested condensed status map entries of the field device. Each entry in the status map corresponds to either a bit of the field device status or a bit of command 48.</p> <p>Two status map codes are packed into a byte. The least significant nibble corresponds to the smaller of the two indices of the status map array.</p> <p>The following is returned by way of response:</p> <ul style="list-style-type: none"> <li>- Byte 0: Current start index of the status map</li> <li>- Byte 1: Number of status map entries to be read</li> <li>- Byte 2.0-2.3: First status map code</li> <li>- Byte 2.4-2.7: Second status map code</li> <li>- Byte 3.0-3.3: Third status map code</li> </ul> <p>...</p> <ul style="list-style-type: none"> <li>- Byte <math>(2+(n-2)/2).0-</math> <math>(2+(n-2)/2).3</math>: <math>(n-1)</math>-th status map code</li> <li>- Byte <math>(2+(n-2)/2).4-</math> <math>(2+(n-2)/2).7</math>: <math>n</math>-th status map code</li> </ul>
524 (HART 7)	Write condensed status mapping Access = write	<p>This command changes the status map of the field device. Each entry in the status map corresponds to either a bit of the field device status or a bit of command 48.</p> <p>Two status map codes are packed into a byte. The least significant nibble corresponds to the smaller of the two indices of the status map array.</p> <p> <b>Note!</b> Modified mapping is active immediately as soon as this command is executed and can therefore cause immediate changes to the condensed status.</p> <p>This command must always write at least two status map entries. This means that the number of entries to be written must always be an even number.</p> <ul style="list-style-type: none"> <li>- Byte 0: Current start index of the status map</li> <li>- Byte 1: Number of status map entries to be written</li> <li>- Byte 2.0-2.3: First status map code</li> <li>- Byte 2.4-2.7: Second status map code</li> <li>- Byte 3.0-3.3: Third status map code</li> </ul> <p>...</p> <ul style="list-style-type: none"> <li>- Byte <math>(2+(n-2)/2).0-</math> <math>(2+(n-2)/2).3</math>: <math>(n-1)</math>-th status map code</li> <li>- Byte <math>(2+(n-2)/2).4-</math> <math>(2+(n-2)/2).7</math>: <math>n</math>-th status map code</li> </ul>	<ul style="list-style-type: none"> <li>- Byte 0: Current start index of the status map</li> <li>- Byte 1: Number of status map entries to be written</li> <li>- Byte 2.0-2.3: First status map code</li> <li>- Byte 2.4-2.7: Second status map code</li> <li>- Byte 3.0-3.3: Third status map code</li> </ul> <p>...</p> <ul style="list-style-type: none"> <li>- Byte <math>(2+(n-2)/2).0-</math> <math>(2+(n-2)/2).3</math>: <math>(n-1)</math>-th status map code</li> <li>- Byte <math>(2+(n-2)/2).4-</math> <math>(2+(n-2)/2).7</math>: <math>n</math>-th status map code</li> </ul>
525 (HART 7)	Reset condensed status map Access = write	<p>none</p> <p>This command resets the status map (i.e. the default values for the status map are written to the status map array).</p> <p> <b>Note!</b> The condensed status map reset becomes effective immediately as soon as this command is executed and can result in immediate changes to the condensed status</p>	<p>none</p>

Command No. HART command / Access type		Command data (numeric data in decimal form)	Response data (numeric data in decimal form)
526 (HART 7)	Write simulation status mode Access = write	<p>Byte 0: Status simulation mode code</p> <p>This command is used to activate or deactivate status simulation mode.</p> <p>The status simulation mode enables the point-to-point verification of the system response to changes in the device status or command 48 response.</p> <p>If status simulation is enabled:</p> <ul style="list-style-type: none"> <li>- all device-initiated changes to the device status and command 48 response are disabled</li> <li>- the simulation status active bit is set</li> </ul> <p>When status simulation is enabled, the device status and command 48 response are influenced by the host application only when command 527 is received.</p> <p>If status simulation is disabled:</p> <ul style="list-style-type: none"> <li>- the simulation status active bit is reset</li> <li>- the current values that apply for the device status and command 48 response are active</li> <li>- Normal internal updating of the device status and command 48 response are resumed</li> </ul> <p>The status simulation mode is also disabled if power supply to the device is interrupted or if the device is reset.</p>	<p>The following is returned by way of response:</p> <p>Byte 0: Status simulation mode code</p>
527 (HART 7)	Simulation status bit Access = write	<p>Byte 0: Index of the simulated bit</p> <p>Byte 1: Value of the simulated bit</p> <p>When the status simulation mode is enabled, this command allows the device status bits or the bits in the command 48 response to be set or reset individually.</p>	<p>The following is returned by way of response:</p> <p>Byte 0: Index of the simulated bit</p> <p>Byte 1: Value of the simulated bit</p>



### 5.4.5 Device status / Error messages

You can read the extended device status, in this case, current error messages, via Command "48". The command delivers information which are partly coded in bits (see table below).



Note!

Explanation of the device status and error messages and their elimination ® Page 84 ff.

#### HART 5

Byte-bit	Error No.	Short error description → 87.
0-0	001	Serious device error
0-1	011	Measuring amplifier has faulty EEPROM
0-2	012	Error when accessing data of the measuring amplifier EEPROM
1-1	031	S-DAT: Defective or missing
1-2	032	S-DAT: Error accessing saved values
1-3	041	T-DAT: Defective or missing
1-4	042	T-DAT: Error accessing saved values
1-5	051	I/O board and the amplifier board are not compatible.
3-3	111	Totalizer checksum error
3-4	121	I/O board and the amplifier board (software versions) are not compatible.
3-6	205	T-DAT: Data download not successful
3-7	206	T-DAT: Data upload not successful
4-3	251	Internal communication fault on the amplifier board.
4-4	261	No data reception between amplifier and I/O board
5-7	339	Flow buffer: The temporarily buffered flow portions (measuring mode for pulsating flow) could not be cleared or output within 60 seconds.
6-0	340	
6-1	341	
6-2	342	
6-3	343	Frequency buffer: The temporarily buffered flow portions (measuring mode for pulsating flow) could not be cleared or output within 60 seconds.
6-4	344	
6-5	345	
6-6	346	
6-7	347	Pulse buffer: The temporarily buffered flow portions (measuring mode for pulsating flow) could not be cleared or output within 60 seconds.
7-0	348	
7-1	349	
7-2	350	
7-3	351	Current output: The actual value for the flow lies outside the set limits.
7-4	352	
7-5	353	
7-6	354	
7-7	355	Frequency output: The actual value for the flow lies outside the set limits.
8-0	356	
8-1	357	
8-2	358	

Byte-bit	Error No.	Short error description → 87.
8-3	359	Pulse output: Pulse output frequency is out of range.
8-4	360	
8-5	361	
8-6	362	
9-0	379	The measuring tube oscillation frequency is outside the permitted range.
9-1	380	
9-2	381	The temperature sensor on the measuring tube is likely defective.
9-3	382	
9-4	383	The temperature sensor on the carrier tube is likely defective.
9-5	384	
9-6	385	One of the measuring tube exciter coils (inlet or outlet) is likely defective.
9-7	386	
10-0	387	
10-1	388	Amplifier error
10-2	389	
10-3	390	
11-6	471	Max. permitted batching time has been exceeded.
11-7	472	Underbatching: the minimum quantity was not reached. Overbatching: the maximum permitted batching quantity was exceeded.
12-0	473	The predefined batch quantity point was exceeded. End of filling process approaching.
12-1	474	Maximum flow value entered is overshoot.
12-7	501	New amplifier software version is loaded. Currently no other commands are possible.
13-0	502	Upload and download of device files. Currently no other commands are possible.
13-2	571	Batching process in progress (valves are open)
13-3	572	Batching process has been stopped (valves are closed)
13-5	586	The fluid properties do not allow normal measuring operation.
13-6	587	Extreme process conditions exist. The measuring system can therefore not be started.
13-7	588	Overdriving of the internal analog to digital converter. A continuation of the measurement is no longer possible!
14-3	601	Positive zero return active
14-7	611	Simulation current output active
15-0	612	
15-1	613	
15-2	614	
15-3	621	Simulation frequency output active
15-4	622	
15-5	623	
15-6	624	

Byte-bit	Error No.	Short error description → 87.
15-7	631	Simulation pulse output active
16-0	632	
16-1	633	
16-2	634	
16-3	641	Simulation status output active
16-4	642	
16-5	643	
16-6	644	
16-7	651	Simulation relay output active
17-0	652	
17-1	653	
17-2	654	
17-3	661	Simulation current input active
17-4	662	
17-5	663	
17-6	664	
17-7	671	Simulation status input active
18-0	672	
18-1	673	
18-2	674	
18-3	691	Simulation of response to error (outputs) active
18-4	692	Simulation of volume flow active
19-0	700	The process fluid density is outside the upper or lower limit values set in the "EPD" function
19-1	701	The maximum current value for the measuring tube exciter coils has been reached, since certain process fluid characteristics are extreme.
19-2	702	Frequency control is not stable, due to inhomogeneous fluid.
19-3	703	NOISE LIM. CH0 Overdriving of the internal analog to digital converter. A continuation of the measurement is still possible!
19-4	704	NOISE LIM. CH1 Overdriving of the internal analog to digital converter. A continuation of the measurement is still possible!
19-5	705	The electronics' measuring range will be exceeded. The mass flow is too high.
20-5	731	The zero point adjustment is not possible or has been canceled.
22-4	61	F-Chip is faulty or not plugged into the I/O board.
24-5	363	Current input: The actual value for the current lies outside the set limits.

**HART 7**

Byte-bit	Error No.	Short error description → 87.
0-0	001	Serious device error
0-1	011	Measuring amplifier has faulty EEPROM
0-2	012	Error when accessing data of the measuring amplifier EEPROM
0-3	031	S-DAT: Defective
0-4	032	S-DAT: missing
0-5	041	T-DAT: Defective or missing
0-6	042	T-DAT: Error accessing saved values
0-7	111	Totalizer checksum error
1-0	205	T-DAT: Data download not successful
1-1	206	T-DAT: Data upload not successful
1-2	251	Internal communication fault on the amplifier board.
1-3	261	No data reception between amplifier and I/O board
1-5	355	Frequency output: The actual value for the flow lies outside the set limits.
1-6	356	
1-7	357	
2-0	358	
2-1	359	Pulse output: Pulse output frequency is out of range.
2-2	360	
2-3	361	
2-4	362	
2-5	379	The measuring tube oscillation frequency is outside the permitted range.
2-6	380	
2-7	381	The temperature sensor on the measuring tube is likely defective.
3-0	382	
3-1	383	The temperature sensor on the carrier tube is likely defective.
3-2	384	
3-3	385	One of the measuring tube exciter coils (inlet or outlet) is likely defective
3-4	386	
3-5	387	
3-6	388	Amplifier error
3-7	389	
4-0	390	
4-1	502	Upload and download of device files. Currently no other commands are possible.
4-2	586	The fluid properties do not allow normal measuring operation.
4-3	587	Extreme process conditions exist. The measuring system can therefore not be started.
4-4	588	Overdriving of the internal analog to digital converter. A continuation of the measurement is no longer possible!
4-5	601	Positive zero return active

Byte-bit	Error No.	Short error description → 87.
4-6	621	Simulation frequency output active
4-7	622	
5-0	623	
5-1	624	
5-2	631	Simulation pulse output active
5-3	632	
5-4	633	
5-5	634	
5-6	641	Simulation status output active
5-7	642	
10-0	351	Current output: The actual value for the flow lies outside the set limits.
10-1	352	
10-2	353	
10-3	354	
13-0	611	Simulation current output active
13-1	612	
13-2	613	
13-3	614	
14-0	643	Simulation status output active
14-1	644	
14-2	651	Simulation relay output active
14-3	652	
14-4	653	
14-5	654	
14-6	661	Simulation current input active
15-2	671	Simulation status input active
15-3	672	
15-4	673	
15-5	674	
15-6	691	Simulation of response to error (outputs) active
15-7	692	Simulation of volume flow active
16-0	700	The process fluid density is outside the upper or lower limit values set in the "EPD" function
16-1	701	The maximum current value for the measuring tube exciter coils has been reached, since certain process fluid characteristics are extreme.
16-2	702	Frequency control is not stable, due to inhomogeneous fluid.
16-3	703	Overdriving of the internal analog to digital converter.
16-4	704	A continuation of the measurement is still possible!
16-5	705	The electronics' measuring range will be exceeded. The mass flow is too high.
16-6	800	Advanced Diagnostics: The mass flow is outside the limit value, set in the corresponding diagnosis function
16-7	801	Advanced Diagnostics: The density is outside the limit value, set in the corresponding diagnosis function.

Byte-bit	Error No.	Short error description →  87.
17-0	802	Advanced Diagnostics: The reference density is outside the limit value, set in the corresponding diagnosis function.
17-1	803	Advanced Diagnostics: The temperature is outside the limit value, set in the corresponding diagnosis function.
17-2	804	Advanced Diagnostics: The tube damping is outside the limit value, set in the corresponding diagnosis function.
17-3	805	Advanced Diagnostics: The electrodynamic sensor is outside the limit value, set in the corresponding diagnosis function.
17-4	731	The zero point adjustment is not possible or has been canceled.
17-5	471	The maximum permitted batching time was exceeded.
17-6	472	Under batching: The minimum quantity was not reached. Over batching: The maximum permitted batching quantity was exceeded.
17-7	473	The predefined batch quantity point was exceeded. End of filling process approaching
18-0	571	Batching is started and active (valves are open)
18-1	572	Batching has been interrupted (valves are closed)
18-2	339	Flow buffer: The temporarily buffered flow portions (measuring mode for pulsating flow) could not be cleared or output within 60 seconds.
18-3	340	
18-4	341	
18-5	342	
18-6	343	
18-7	344	Frequency buffer: The temporarily buffered flow portions (measuring mode for pulsating flow) could not be cleared or output within 60 seconds.
19-0	345	
19-1	346	
19-2	347	Pulse buffer: The temporarily buffered flow portions (measuring mode for pulsating flow) could not be cleared or output within 60 seconds.
19-3	348	
19-4	349	
19-5	350	
19-6	121	
19-7	061	F-Chip is faulty or not plugged into the I/O board.
20-0	363	Current input: The actual value for the current lies outside the set limits.
20-4	698	The measuring device is being checked on site via the test and simulation device.
20-5	474	Maximum flow value entered is overshoot.
20-6	806	Advanced Diagnostics: The fluctuation of the operating frequency is outside the limit value set in the corresponding diagnosis functions.
20-7	807	Advanced Diagnostics: The fluctuation of the pipe damping is outside the limit value set in the corresponding diagnosis functions.

### 5.4.6 Switching HART write protection on and off

A jumper on the I/O board provides the means of switching HART write protection on or off.



**Warning!**

Risk of electric shock. Exposed components carry dangerous voltages. Make sure that the power supply is switched off before you remove the cover of the electronics compartment.

1. Switch off power supply.
2. Remove the I/O board → 98
3. Switch HART write protection on or off, as applicable, by means of the jumper → 33.
4. Installation of the I/O board is the reverse of the removal procedure.

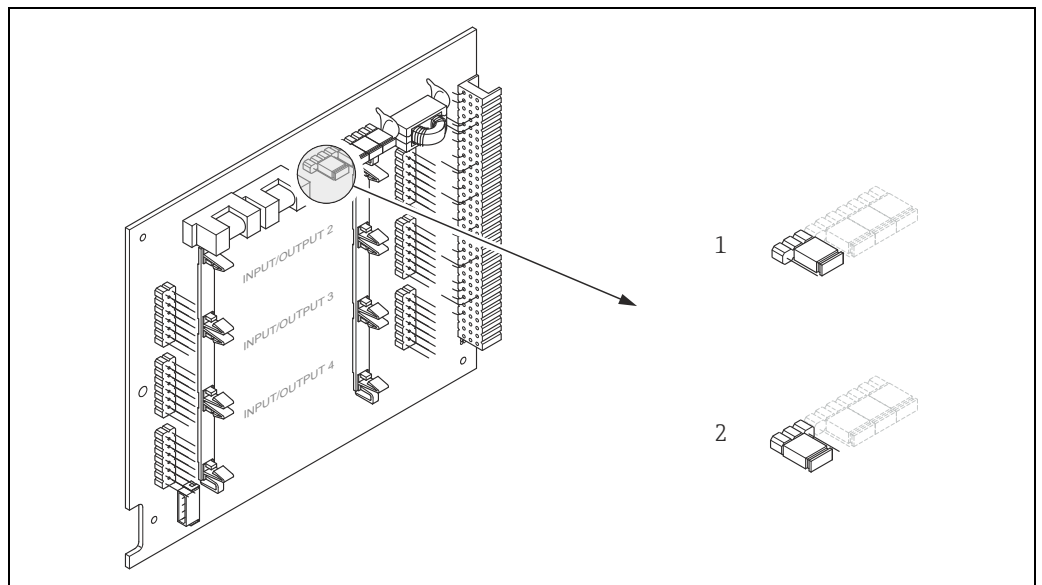

Fig. 33: Switching HART write protection on and off

- 1 Write protection OFF (default), that is: HART protocol unlocked
- 2 Write protection ON, that is: HART protocol locked

a00012.12

## 6 Commissioning

### 6.1 Function check

Make sure that the following function checks have been performed successfully before switching on the supply voltage for the measuring device:

- Checklist for "Post-installation check" →  24
- Checklist for "Post-connection check" →  30

### 6.2 Switching on the measuring device

Once the function check has been performed successfully, the device is operational and can be switched on via the supply voltage. The device then performs internal test functions and the following messages are shown on the local display:

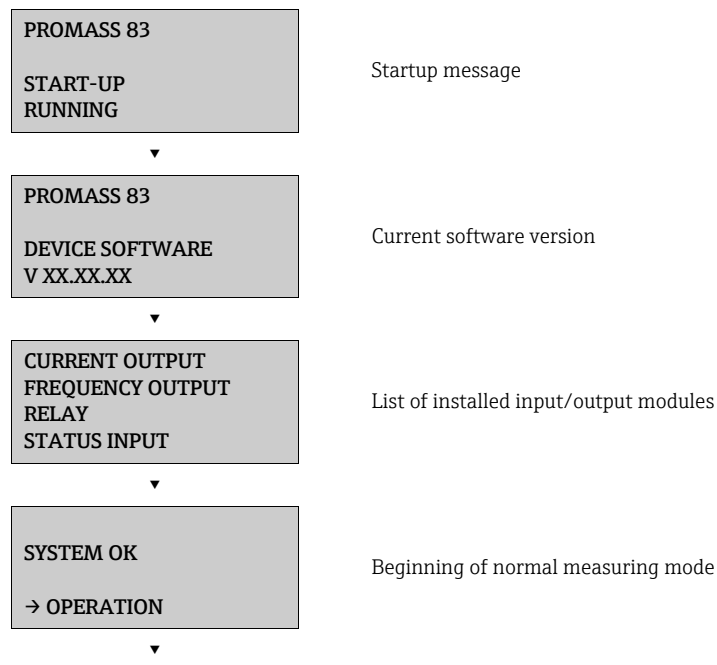

Normal measuring mode commences as soon as startup completes.

Various measured value and/or status variables appear on the display (HOME position).



Note!

If startup fails, an error message indicating the cause is displayed.



### 6.3 Quick Setup

In the case of measuring devices without a local display, the individual parameters and functions must be configured via the configuration program, e.g. FieldCare. If the measuring device is equipped with a local display, all the important device parameters for standard operation, as well as additional functions, can be configured quickly and easily by means of the following Quick Setup menus.

#### 6.3.1 Quick Setup "Commissioning"

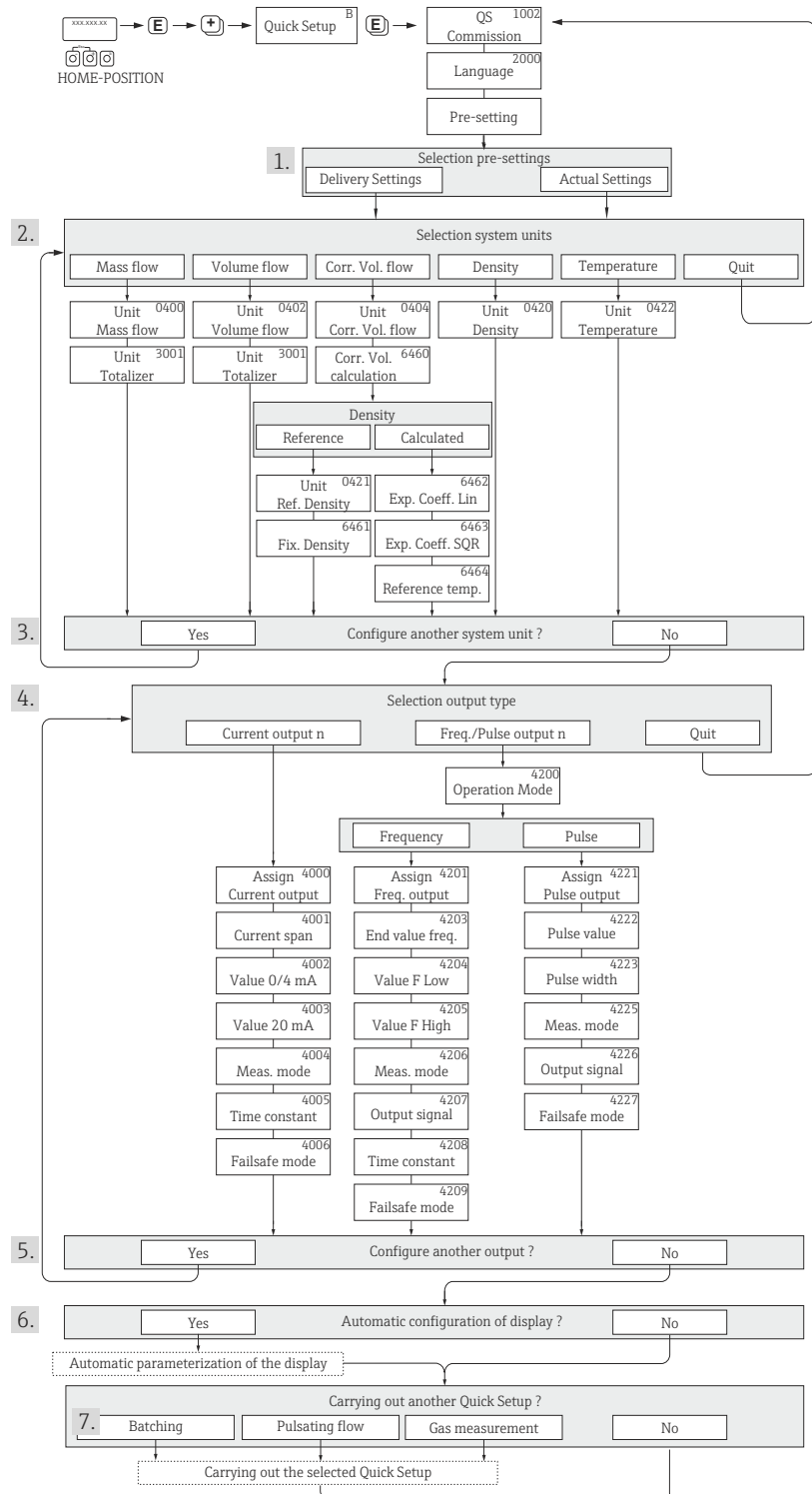

Fig. 34: "QUICK SETUP COMMISSIONING" menu for straightforward configuration of the major device functions

a0004561-en

**Note!**

- The display returns to the cell SETUP COMMISSIONING (1002) if you press the  $\square$  key combination during parameter interrogation. The stored parameters remain valid.
  - The "Commissioning" Quick Setup must be carried out before one of the Quick Setups explained below is run.
- 1 The "DELIVERY SETTING" option sets every selected unit to the factory setting. The "ACTUAL SETTING" option accepts the units you previously configured.
  - 2 Only units not yet configured in the current Setup are offered for selection in each cycle. The unit for mass, volume and corrected volume is derived from the corresponding flow unit.
  - 3 The "YES" option remains visible until all the units have been configured. "NO" is the only option displayed when no further units are available.
  - 4 Only outputs not yet configured in the current Setup are offered for selection in each cycle.
  - 5 The "YES" option remains visible until all the outputs have been configured. "NO" is the only option displayed when no further outputs are available.
  - 6 The "automatic parameterization of the display" option contains the following basic settings/factory settings:
    - YES: Main line = Mass flow; Additional line = Totalizer 1;  
Information line = Operating/system conditions
    - NO: The existing (selected) settings remain.
  - 7 The QUICK SETUP BATCHING is only available when the optional software package BATCHING is installed.

### 6.3.2 "Pulsating Flow" Quick Setup menu

Certain types of pump such as reciprocating, peristaltic and cam-type pumps, for example, create a flow characterized by severe periodic fluctuations. Negative flows can occur with pumps of these types on account of the closing volume of the valves or valve leaks.

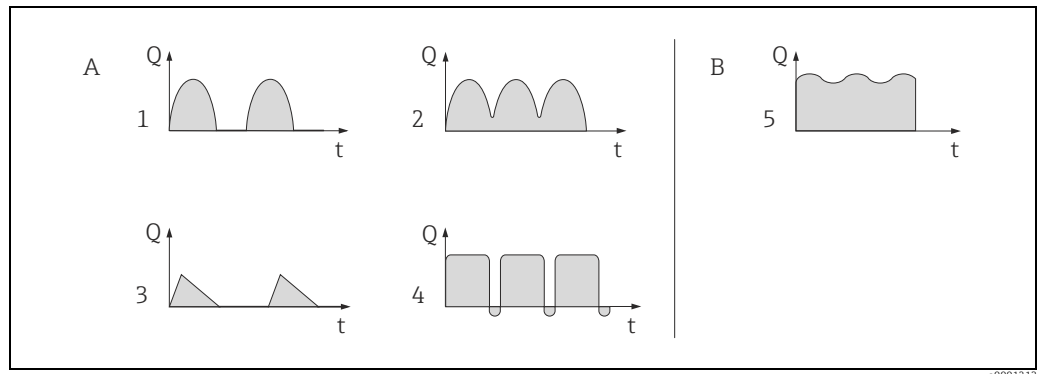

Fig. 35: Flow characteristics of various types of pump

A With severely pulsating flow  
B With low pulsating flow

- 1 1-cylinder cam pump
- 2 2-cylinder cam pump
- 3 Magnetic pump
- 4 Peristaltic pump, flexible connecting hose
- 5 Multi-cylinder reciprocating pump



Note!

Before carrying out the Quick Setup "Pulsating Flow" the Quick Setup "Commissioning." → 

#### Severely pulsating flow

Once several device functions have been configured in the "Pulsating flow" Quick Setup menu, flow fluctuations of this nature can be compensated over the entire flow range and pulsating fluid flows measured correctly. You will find detailed instructions on how to use this Quick Setup menu below.



Note!

It is always advisable to work through the "Pulsating flow" Quick Setup menu if there is any uncertainty about the exact flow characteristic.

#### Slightly pulsating flow

If flow fluctuations are no more than minor, as is the case, for example with gear-type, three-cylinder or multi-cylinder pumps, it is **not** absolutely necessary to work through the Quick Setup menu.

In cases of this nature, however, it is advisable to adapt the functions listed below (see the "Description of Device Functions" manual) to suit local process conditions in order to ensure a stable, unvarying output signal. This applies in particular to the current output:

- Measuring system damping: FLOW DAMPING function → increase value
- Current output damping: TIME CONSTANT function → increase the value

## Performing the "Pulsating flow" Quick Setup

This Quick Setup menu guides you systematically through the setup procedure for all the device functions that have to be parameterized and configured for measuring pulsating flows. Note that this has no effect on values configured beforehand, such as measuring range, current range or full scale value!

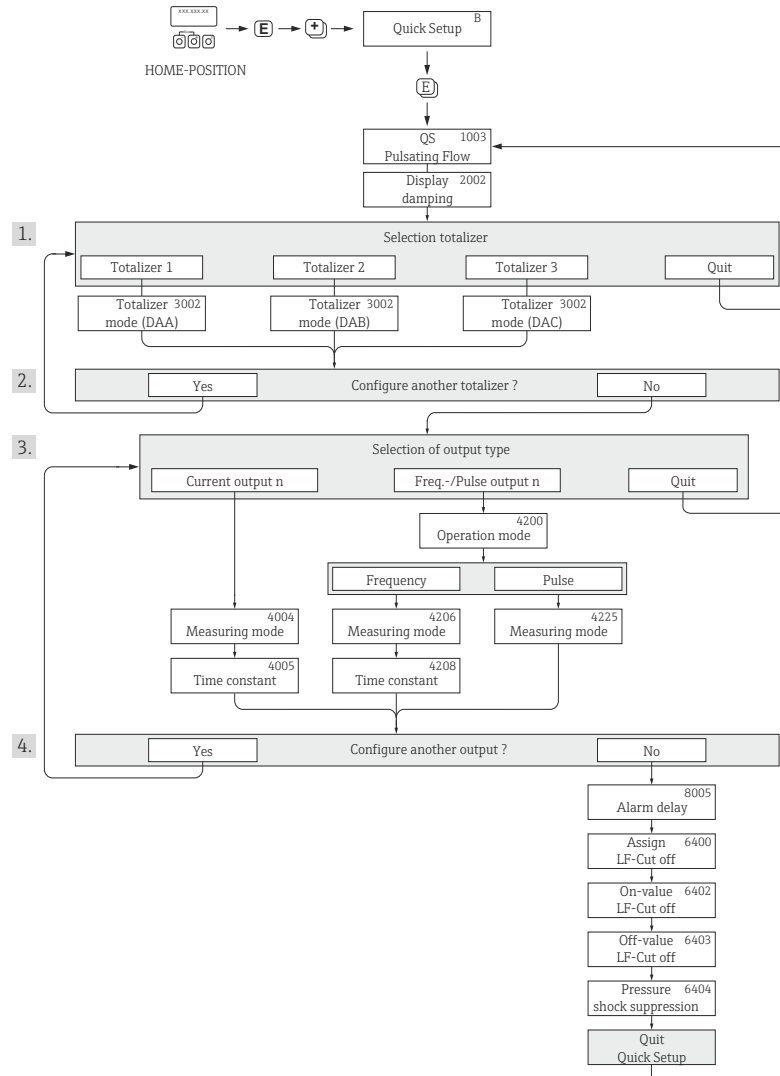

a0002615-en

Fig. 36: Quick Setup for measuring severely pulsating flows.  
Recommended settings are found on the following page.

- 1 Only the counters not yet configured in the current Setup are offered for selection in each cycle.
- 2 The "YES" option remains visible until all the counters have been configured. "NO" is the only option displayed when no further counters are available.
- 3 Only the outputs not yet configured in the current Setup are offered for selection in each cycle.
- 4 The "YES" option remains visible until all the outputs have been configured. "NO" is the only option displayed when no further outputs are available.



### Note!

- The display returns to the cell QUICK SETUP PULSATING FLOW (1003) if you press the  key combination during parameter interrogation.
- The Setups can be called up either directly after the "COMMISSIONING" Quick Setup or manually by means of the QUICK SETUP PULSATING FLOW (1003) function.

### Recommended settings

"Pulsating Flow" Quick Setup menu		
HOME-Position →  → MEASURED VARIABLE (A) MEASURED VARIABLE →  → QUICK SETUP (B) QUICK SETUP →  → QS PULS. FLOW (1003)		
Function No.	Function name	Selection with (  )
1003	QS PULSATING FLOW	YES After  is pressed by way of confirmation, the Quick Setup menu calls up all the subsequent functions in succession.
▼		
Basic configuration		
2002	DISPLAY DAMPING	1 s
3002	TOTALIZER MODE (DAA)	BALANCE (Totalizer 1)
3002	TOTALIZER MODE (DAB)	BALANCE (Totalizer 2)
3002	TOTALIZER MODE (DAC)	BALANCE (Totalizer 3)
Signal type for "CURRENT OUTPUT 1 to n"		
4004	MEASURING MODE	PULSATING FLOW
4005	TIME CONSTANT	1 s
Signal type for "FREQ./PULSE OUTPUT 1 to n" (for FREQUENCY operating mode)		
4206	MEASURING MODE	PULSATING FLOW
4208	TIME CONSTANT	0 s
Signal type for "FREQ./PULSE OUTPUT 1 to n" (for PULSE operating mode)		
4225	MEASURING MODE	PULSATING FLOW
Other settings		
8005	ALARM DELAY	0 s
6400	ASSIGN LOW FLOW CUTOFF	MASS FLOW
6402	ON-VALUE LOW FLOW CUTOFF	Setting depends on diameter: DN 1 = 0.02 [kg/h] or [l/h] DN 2 = 0.10 [kg/h] or [l/h] DN 4 = 0.45 [kg/h] or [l/h] DN 8 = 2.0 [kg/h] or [l/h] DN 15 = 6.5 [kg/h] or [l/h] DN 15 FB = 18 [kg/h] resp. [l/h] DN 25 = 18 [kg/h] resp. [l/h] DN 25 FB = 45 [kg/h] resp. [l/h] DN 40 = 45 [kg/h] resp. [l/h] DN 40 FB = 70 [kg/h] resp. [l/h] DN 50 = 70 [kg/h] resp. [l/h] DN 50 FB = 180 [kg/h] resp. [l/h] DN 80 = 180 [kg/h] or [l/h] DN 100 = 350 [kg/h] or [l/h] DN 150 = 650 [kg/h] or [l/h] DN 250 = 1800 [kg/h] or [l/h] DN 350 = 3250 [kg/h] or [l/h]  FB = Full bore versions of Promass I
6403	OFF-VALUE LOW FLOW CUTOFF	50%
6404	PRESSURE SHOCK SUPPRESSION	0 s
▼		
Back to the HOME position: → Press and hold down Esc key  for longer than three seconds or → Repeatedly press and release Esc key  → Exit the function matrix step by step		

### 6.3.3 "Batching" Quick Setup menu

This Quick Setup menu guides you systematically through the setup procedure for all the device functions that have to be parameterized and configured for batching operation. These basic settings allow simple (one step) batching processes.

Additional settings, e.g. for the calculation of after runs or for multi-stage batching procedures, must be made via the function matrix itself (see the "Description of Device Functions" manual).



#### Caution!

The "Batching" Quick Setup sets certain device parameters for discontinuous measurement operation.

If the measuring instrument is used for continuous flow measurement at a later time, we recommend at you rerun the "Commissioning" and/or "Pulsating Flow" Quick Setup.



#### Note!



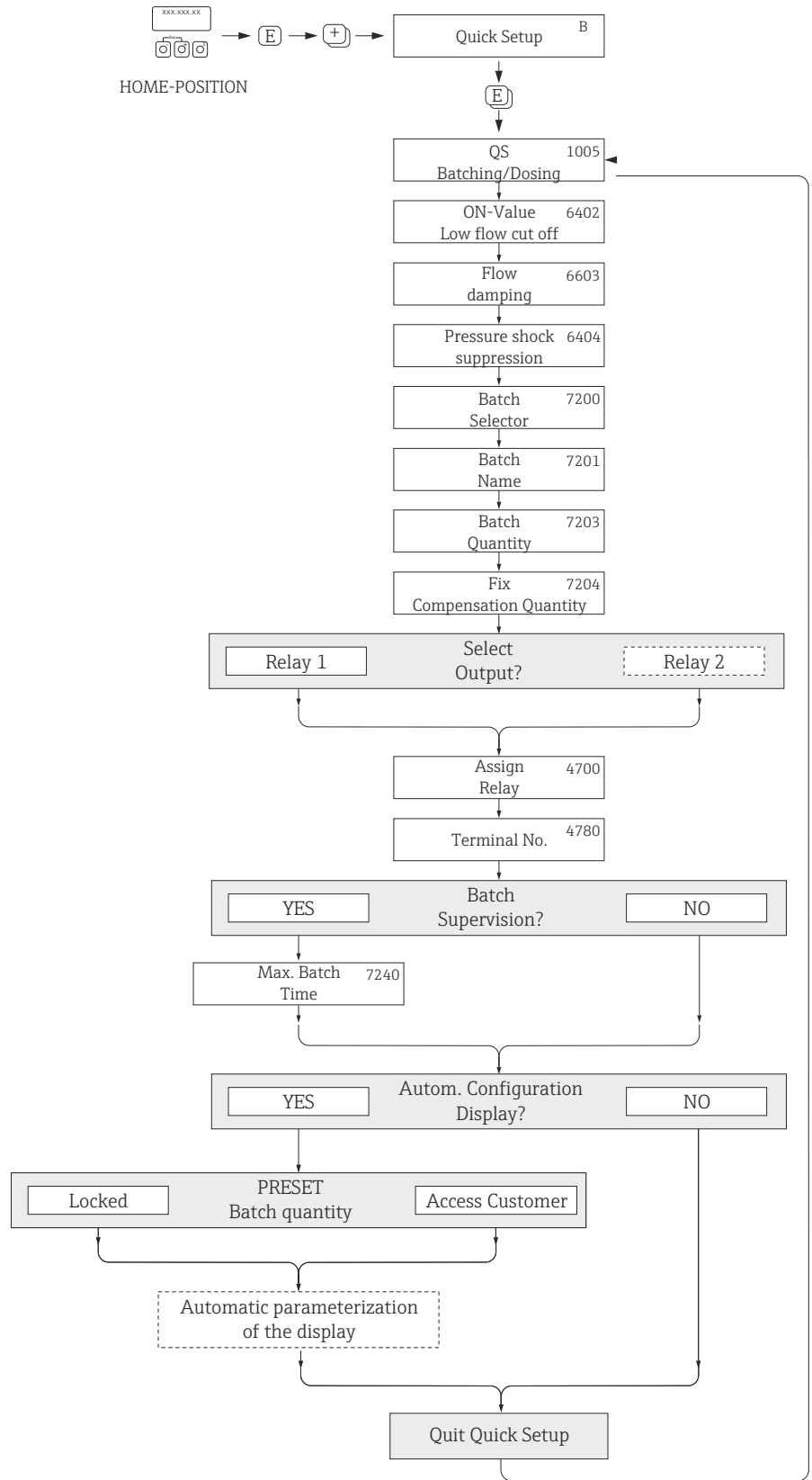







- Before carrying out the Quick Setup "Batching" the Quick Setup "Commissioning" has to be executed. → 57
- This function is only available when the additional "batching" software is installed in the measuring device (order option). You can order this software from E+H as an accessory at a later date. → 85
- You can find detailed information on the batching functions in the separate "Description of Device Functions" manual.
- You can also directly control filling process using the local display. During Quick Setup, an appropriate dialog appears concerning the automatic display configuration. Acknowledge this by clicking "YES".  
This assigns special batching functions (START, PRESET, MATRIX) to the bottom line of the display. These can be directly executed onsite using the three operating keys ( / / ). Therefore, the measuring device can be fully deployed in the field as a "batch controller". → 34
- The Quick Setup "Batching" is not available for Promass X.



a0004644-en

Fig. 37: Quick Setup "Batching"  
 Recommended settings are found on the following page.

### Recommended settings

"Batching" Quick Setup menu		
HOME-Position →  → MEASURED VARIABLE (A) MEASURED VARIABLE →  → QUICK SETUP (B) QUICK SETUP →  → QUICK SETUP BATCHING (1005)		
Function No.	Function name	Setting to be selected (  ) (to next function with  )
1005	QUICK SETUP BATCHING / DOSING	YES After  is pressed by way of confirmation, the Quick Setup menu calls up all the subsequent functions in succession.
▼		
 <b>Note!</b> Functions with a gray background are configured automatically (by the measuring system itself)		
6400	ASSIGN LOW FLOW CUTOFF	MASS FLOW
6402	ON-VALUE LOW FLOW CUTOFF	See Table on →  65
6403	OFF-VALUE LOW FLOW CUTOFF	50%
6603	FLOW DAMPING	0 seconds
6404	PRESSURE SHOCK SUPPRESSION	0 seconds
7200	BATCH SELECTOR	BATCH #1
7201	BATCH NAME	BATCH #1
7202	ASSIGN BATCH VARIABLE	MASS
7203	BATCH QUANTITY	0
7204	FIXED CORRECTION QUANTITY	0
7205	CORRECTION MODE	OFF
7208	BATCH STAGES	1
7209	INPUT FORMAT	VALUE INPUT
4700	ASSIGN RELAY	BATCH VALVE 1
4780	TERMINAL NUMBER	Output (display only)
7220	OPEN VALVE 1	0% or 0 [unit]
7240	MAXIMUM BATCH TIME	0 seconds (= switched off)
7241	MINIMUM BATCH QUANTITY	0
7242	MAXIMUM BATCH QUANTITY	0
2200	ASSIGN (main line)	BATCH NAME
2220	ASSIGN (Multiplex main line)	OFF
2400	ASSIGN (additional line)	BATCH DOWNWARDS
2420	ASSIGN (Multiplex additional line)	OFF
2600	ASSIGN (information line)	BATCHING KEYS
2620	ASSIGN (Multiplex information line)	OFF
▼		
Back to the HOME position: → Press and hold down Esc key  for longer than three seconds or → Repeatedly press and release Esc key  → Exit the function matrix step by step		



DN		Low flow cut off / factory settings (v ~ 0.04 m/s (0.13 ft/s))	
		SI units [kg/h]	US units [lb/min]
1	1/24"	0.08	0.003
2	1/12"	0.4	0.015
4	1/8"	1.8	0.066
8	3/8"	8	0.3
15	1/2"	26	1.0
15 FB	1/2"	72	2.6
25	1"	72	2.6
25 FB	1"	180	6.6
40	1 1/2"	180	6.6
40 FB	1 1/2"	300	11
50	2"	300	11
50 FB	2"	720	26
80	3"	720	26
100	4"	1200	44
150	6"	2600	95
250	10"	7200	260

FB = Full bore versions of Promass I

### 6.3.4 "Gas Measurement" Quick Setup menu

The measuring device is not only suitable for measuring liquid flow. Direct mass measurement based on the Coriolis principle is also possible for measuring the flow rate of gases.



Note!

- Before carrying out the Quick Setup "Gas measurement" the Quick Setup "Commissioning" has to be executed → 57 → 60.
- Only mass and Corrected volume flow can be measured and output with the gas measurement mode. Note that direct density and/or volume measurement is not possible!
- The flow ranges and measuring accuracy that apply to gas measurement are not the same as those for liquids.
- If corrected volume flow (e.g. in Nm<sup>3</sup>/h) is to be measured and output instead of the mass flow (e.g. in kg/h), change the setting for the CORRECTED VOLUME CALCULATION function to "FIXED REFERENCE DENSITY" in the "Commissioning" Quick Setup menu. Corrected volume flow can be assigned as follows:
  - to a display line,
  - to the current output,
  - to the pulse/frequency output.

#### Performing the "Gas Measurement" Quick Setup



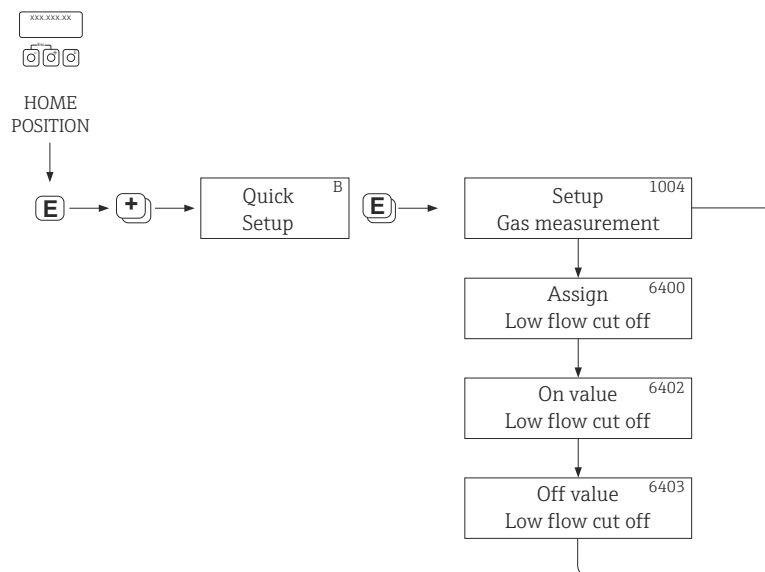





This Quick Setup menu guides you systematically through the setup procedure for all the device functions that have to be parameterized and configured for gas measurement.



a0002618-en

Fig. 38: "Gas Measurement" Quick Setup menu  
Recommended settings are found on the following page.

### Recommended settings

"Gas Measurement" Quick Setup menu		
HOME position →  → MEASURED VARIABLE (A) MEASURED VARIABLE →  → QUICK SETUP (B) QUICK SETUP →  → QS-GAS MEASUREMENT (1004)		
Function No.	Function name	Setting to be selected (  ) (to next function with  )
1004	QS GAS MEASUREMENT	YES After  is pressed by way of confirmation, the Quick Setup menu calls up all the subsequent functions in succession.
▼		
6400	ASSIGN LOW FLOW CUTOFF	On account of the low mass flow involved when gas flows are measured, it is advisable not use a low flow cut off.  Setting: OFF
6402	ON-VALUE LOW FLOW CUTOFF	If the ASSIGNMENT LOW FLOW CUTOFF function was not set to "OFF", the following applies:  Setting: 0.0000 [unit]  User input: Flow rates for gas measurements are low, so the value for the switch-on point (= low flow cut off) must be correspondingly low.
6403	OFF-VALUE LOW FLOW CUTOFF	If the ASSIGNMENT LOW FLOW CUTOFF function was not set to "OFF", the following applies:  Setting: 50%  User input: Enter the switch-off point as a positive hysteresis in %, referenced to the switch-on point.
▼		
Back to the HOME position: → Press and hold down Esc key  for longer than three seconds or → Repeatedly press and release Esc key  → Exit the function matrix step by step		



#### Note!

Quick Setup automatically deactivates the function EMPTY PIPE DETECTION (6420) so that the instrument can measure flow at low gas pressures.

### 6.3.5 Data backup/transmission

Using the T-DAT SAVE/LOAD function, you can transfer data (device parameters and settings) between the T-DAT (exchangeable memory) and the EEPROM (device storage unit).

This is required in the following instances:

- Creating a backup: current data are transferred from an EEPROM to the T-DAT.
- Replacing a transmitter: current data are copied from an EEPROM to the T-DAT and then transferred to the EEPROM of the new transmitter.
- Duplicating data: current data are copied from an EEPROM to the T-DAT and then transferred to EEPROMs of identical measuring points.



Note!

For information on installing and removing the T-DAT → Page 93 ff.

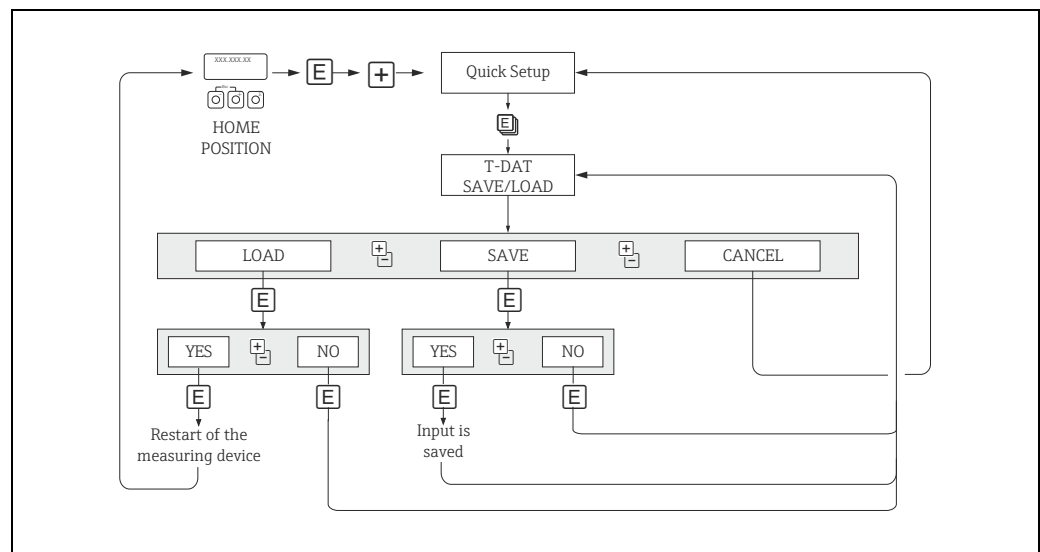

Fig. 39: Data backup/transmission with T-DAT SAVE/LOAD function

Information on the LOAD and SAVE options available:

LOAD: Data are transferred from the T-DAT to the EEPROM.



Note!

- Any settings already saved on the EEPROM are deleted.
- This option is only available, if the T-DAT contains valid data.
- This option can only be executed if the software version of the T-DAT is the same or newer than that of the EEPROM. Otherwise, the error message "TRANSM. SW-DAT" appears after restarting and the LOAD function is then no longer available.

SAVE:

Data are transferred from the EEPROM to the T-DAT

## 6.4 Configuration

### 6.4.1 Two current outputs: active/passive

The current outputs are configured as "active" or "passive" by means of various jumpers on the I/O board or the current submodule.



Caution!

The configuration of the current outputs as "active" or "passive" is only possible on non-Ex i I/O boards. Ex i I/O boards are permanently wired as "active" or "passive", see Table → 28



Warning!

Risk of electric shock. Exposed components carry dangerous voltages. Make sure that the power supply is switched off before you remove the cover of the electronics compartment.

1. Switch off power supply
2. Remove the I/O board → 98
3. Set the jumpers → 40



Caution!

- Risk of destroying the measuring device. Set the jumpers exactly as shown in the diagram. Incorrectly set jumpers can cause overcurrents that would destroy either the measuring device or external devices connected to it.
- Note that the position of the current submodule on the I/O board can vary, depending on the version ordered, and that the terminal assignment in the connection compartment of the transmitter varies accordingly → 28.

4. Installation of the I/O board is the reverse of the removal procedure.

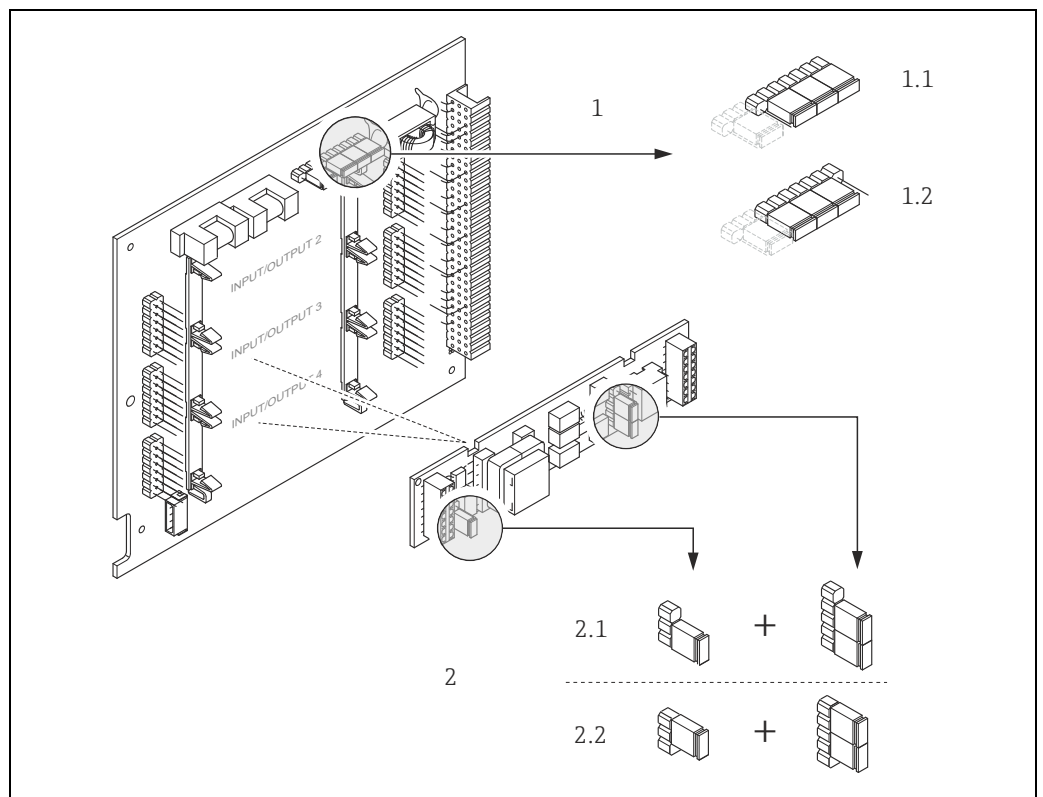

Fig. 40: Configuring current outputs with the aid of jumpers (I/O board)

- 1 Current output 1 with HART
- 1.1 Active current output (default)
- 1.2 Passive current output
- 2 Current output 2 (optional, plug-in module)
- 2.1 Active current output (default)
- 2.2 Passive current output

### 6.4.2 Current input: active/passive

The current outputs are configured as "active" or "passive" by means of various jumpers on the current input submodule.



Warning!

Risk of electric shock.

Exposed components carry dangerous voltages. Make sure that the power supply is switched off before you remove the cover of the electronics compartment.

1. Switch off power supply
2. Remove the I/O board → 98
3. Set the jumpers → 41



Caution!

- Risk of destroying the measuring device. Set the jumpers exactly as shown in the diagram. Incorrectly set jumpers can cause overcurrents that would destroy either the measuring device or external devices connected to it.
- Note that the position of the current submodule on the I/O board can vary, depending on the version ordered, and that the terminal assignment in the connection compartment of the transmitter varies accordingly → 28.

4. Installation of the I/O board is the reverse of the removal procedure.

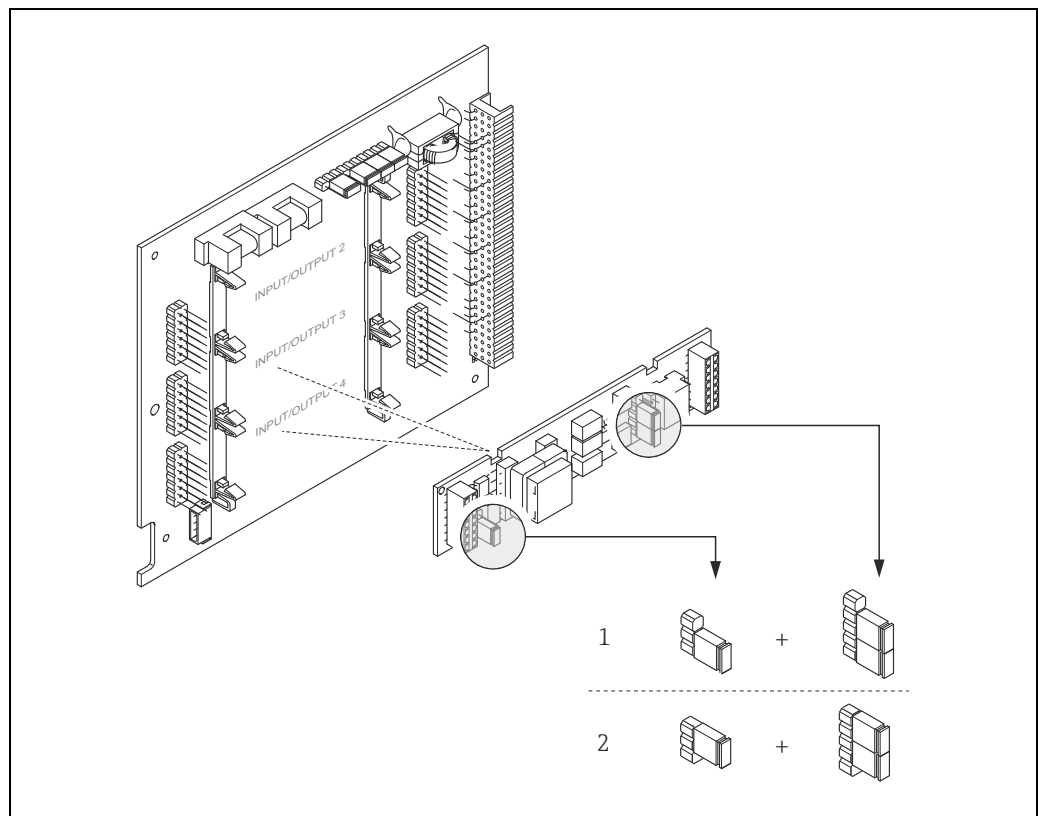

Fig. 41: Configuring current inputs with the aid of jumpers (I/O board)

Current input 1 (optional, plug-in module)

- 1 Active current input (default)
- 2 Passive current input

### 6.4.3 Relay contacts: Normally closed/Normally open

The relay contact can be configured as normally open (NO or make) or normally closed (NC or break) contacts by means of two jumpers on the I/O board or on the pluggable submodule. This configuration can be called up at any time with the ACTUAL STATUS RELAY<sup>®</sup> function (No. 4740).



**Warning!**

Risk of electric shock. Exposed components carry dangerous voltages. Make sure that the power supply is switched off before you remove the cover of the electronics compartment.

1. Switch off power supply
2. Remove the I/O board → 98
3. Set the jumpers → 42



**Caution!**

- If you change the setting you must always change the positions of **both** jumpers! Note precisely the specified positions of the jumpers.
- Note that the position of the relay submodule on the I/O board can vary, depending on the version ordered, and that the terminal assignment in the connection compartment of the transmitter varies accordingly → 28.

4. Installation of the I/O board is the reverse of the removal procedure.

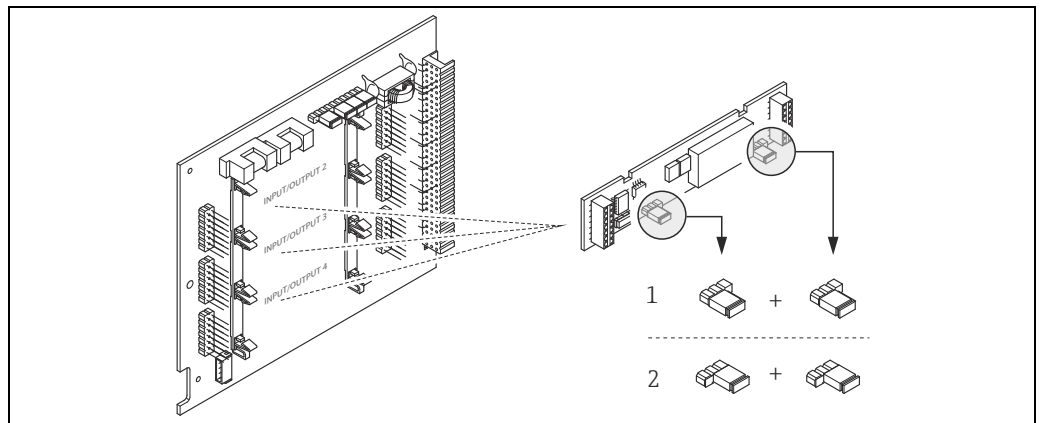

Fig. 42: Configuring relay contacts (NC / NO) on the convertible I/O board (submodule).

- 1 Configured as NO contact (default, relay 1)
- 2 Configured as NC contact (default, relay 2, if installed)

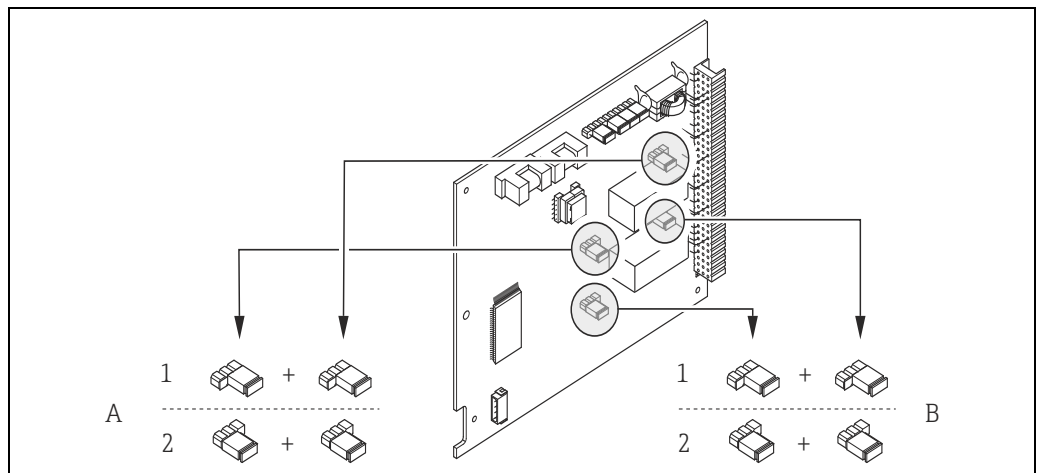

Fig. 43: Configuring relay contacts (NC / NO) on the non-convertible I/O board. A = Relay 1; B = Relay 2

- 1 Configured as NO contact (default, relay 1)
- 2 Configured as NC contact (default, relay 2)

#### 6.4.4 Concentration measurement

The measuring device determines three primary variables simultaneously:

- Mass flow
- Fluid density
- Fluid temperature

As standard, these measured variables allow other process variables to be calculated, such as volume flow, reference density (density at reference temperature) and corrected volume flow.

The optional software package "Concentration measurement" (F-Chip, accessories) offers a multitude of additional density functions. Additional evaluation methods are available in this way, especially for special density calculations in all types of applications: →  85

- Calculating percentage contents, mass and volume flow in two-phase media (carrier fluid and target fluid),
- Converting density of the fluid into special density units (°Brix, °Baumé, °API, etc.).

#### Concentration measurement with fixed calculation function

By means of the DENSITY FUNCTION (7000) function, you can select various density functions which use a fixed specified calculation mode for calculating concentration:

Density function	Remarks
%-MASS %-VOLUME	<p>By using the functions for two-phase-media, it is possible to calculate the percentage mass or volume contents of the carrier fluid or the target fluid. The basic equations (without temperature compensation) are:</p> $\text{Mass [\%]} = \frac{D2 \cdot (\rho - D1)}{\rho \cdot (D2 - D1)} \cdot 100\%$ $\text{Volume [\%]} = \frac{(\rho - D1)}{(D2 - D1)} \cdot 100\%$ <p style="text-align: right;">a0004610-en a0004619-en</p> <p>D1 = density of carrier fluid (transporting liquid, e.g. water) D2 = density of target fluid (material transported, e.g. lime powder or a second liquefied material to be measured) r = measured overall density</p>
°BRIX	<p>Density unit used for the Food &amp; Beverage industry which deals with the saccharose content of aqueous solutions, e.g. for measuring solutions containing sugar such as fruit juice, etc. The following ICUMSA table for Brix units is the basis for calculations within the device.</p>
°BAUME	<p>This density unit or scale is mainly used for acidic solutions, e.g. ferric chloride solutions. Two Baumé scales are used in practice: – BAUME &gt; 1 kg/l: for solutions heavier than water – BAUME &lt; 1 kg/l: for solutions lighter than water</p>
°BALLING °PLATO	<p>Both units are a commonly used basis for calculating the fluid density in the brewery industry. A liquid with a value of 1° BALLING (Plato) has the same fluid density as a water/cane sugar solution consisting of 1 kg cane sugar dissolved in 99 kg of water. 1° Balling (Plato) is thus 1% of the liquid weight.</p>
%-BLACK LIQUOR	<p>The units of concentration used in the paper industry for black liquor in % by mass. The formula used for the calculation is the same as for %-MASS.</p>
°API	<p>°API (= American Petroleum Institute) Density units specifically used in North America for liquefied oil products.</p>



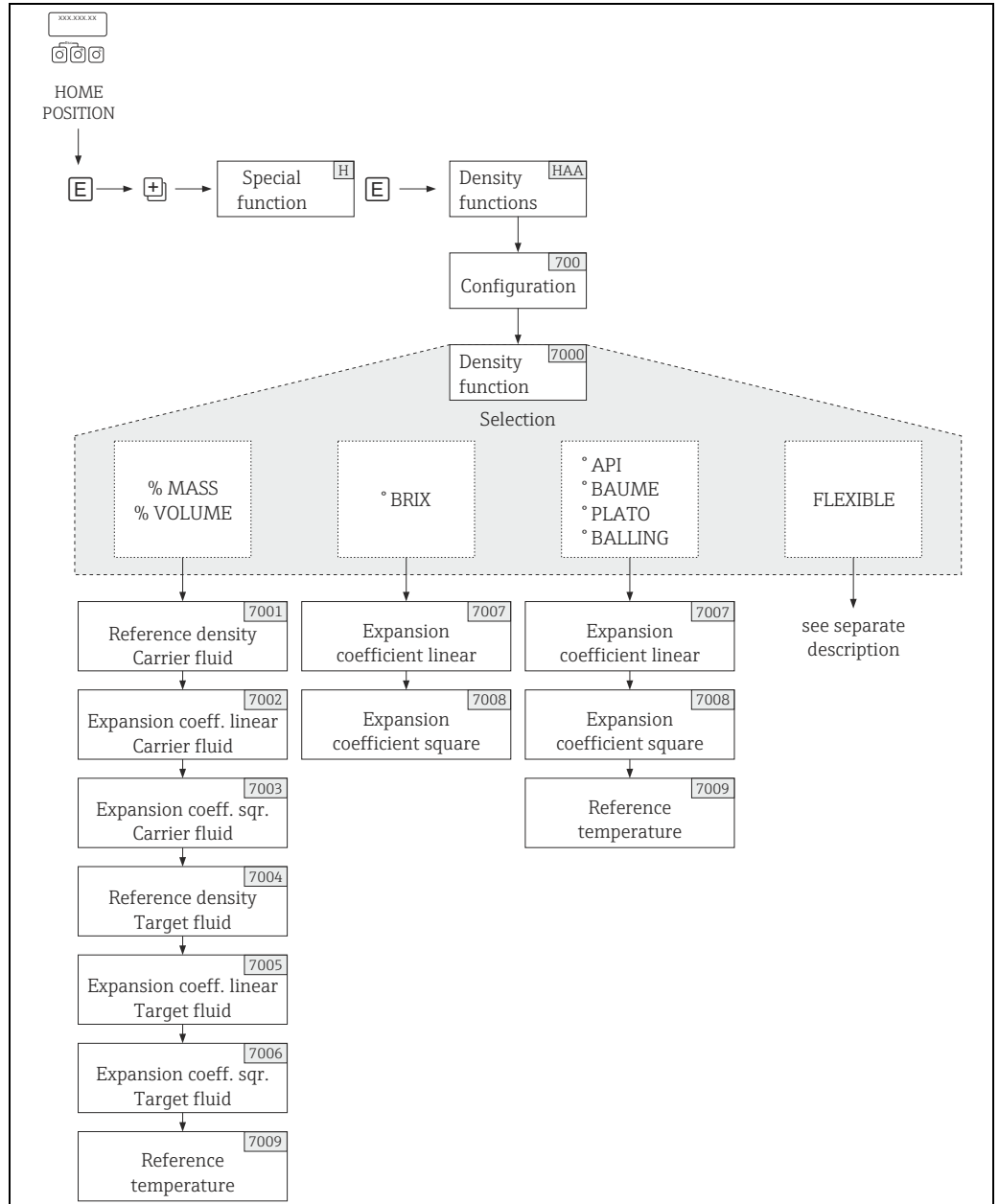

Fig. 44: Selecting and configuring different density functions in the function matrix

Brixgrade (density of hydrous saccharose solution in kg/m <sup>3</sup> )								
°Brix	10°C	20°C	30°C	40°C	50°C	60°C	70°C	80°C
0	999.70	998.20	995.64	992.21	988.03	983.19	977.76	971.78
5	1019.56	1017.79	1015.03	1011.44	1007.14	1002.20	996.70	989.65
10	1040.15	1038.10	1035.13	1031.38	1026.96	1021.93	1016.34	1010.23
15	1061.48	1059.15	1055.97	1052.08	1047.51	1042.39	1036.72	1030.55
20	1083.58	1080.97	1077.58	1073.50	1068.83	1063.60	1057.85	1051.63
25	1106.47	1103.59	1099.98	1095.74	1090.94	1085.61	1079.78	1073.50
30	1130.19	1127.03	1123.20	1118.80	1113.86	1108.44	1102.54	1096.21
35	1154.76	1151.33	1147.58	1142.71	1137.65	1132.13	1126.16	1119.79
40	1180.22	1176.51	1172.25	1167.52	1162.33	1156.71	1150.68	1144.27
45	1206.58	1202.61	1198.15	1193.25	1187.94	1182.23	1176.14	1169.70

Brixgrade (density of hydrous saccharose solution in kg/m <sup>3</sup> )								
°Brix	10°C	20°C	30°C	40°C	50°C	60°C	70°C	80°C
50	1233.87	1229.64	1224.98	1219.93	1214.50	1208.70	1202.56	1196.11
55	1262.11	1257.64	1252.79	1247.59	1242.05	1236.18	1229.98	1223.53
60	1291.31	1286.61	1281.59	1276.25	1270.61	1264.67	1258.45	1251.88
65	1321.46	1316.56	1311.38	1305.93	1300.21	1294.21	1287.96	1281.52
70	1352.55	1347.49	1342.18	1336.63	1330.84	1324.80	1318.55	1312.13
75	1384.58	1379.38	1373.88	1368.36	1362.52	1356.46	1350.21	1343.83
80	1417.50	1412.20	1406.70	1401.10	1395.20	1389.20	1383.00	1376.60
85	1451.30	1445.90	1440.80	1434.80	1429.00	1422.90	1416.80	1410.50

Source: A. & L. Emmerich, Technical University of Brunswick; officially recommended by ICUMSA, 20th session 1990

### Concentration measurement with flexible calculation function

Under certain application conditions, it may not be possible to use density functions with a fixed calculation function (% mass, °Brix, etc.). However, user-specific or application-specific concentration calculations can be used with the "FLEXIBLE" setting in the function DENSITY FUNCTION (7000).

The following types of calculation can be selected in function MODE (7021):

- % MASS 3D
- % VOLUME 3D
- % MASS 2D
- % VOLUME 2D
- OTHER 3D
- OTHER 2D

*Calculation type "% MASS 3D" or "% VOLUME 3D"*

For this type of calculation, the relationship between the three variables - concentration, density and temperature must be known (3-dimensional), e.g. by a table. In this way, the concentration can be calculated from the measured density and temperature values by means of the following formula (the coefficients A0, A1, etc. have to be determined by the user):

$$K = A0 + A1 \cdot \rho + A2 \cdot \rho^2 + A3 \cdot \rho^3 + A4 \cdot \rho^4 + B1 \cdot T + B2 \cdot T^2 + B3 \cdot T^3$$

a0004620

<i>K</i>	<i>Concentration</i>
<i>r</i>	<i>Currently measured density</i>
<i>A0</i>	<i>Value from function (COEFFICIENT A0 (7032))</i>
<i>A1</i>	<i>Value from function (COEFFICIENT A1 (7033))</i>
<i>A2</i>	<i>Value from function (COEFFICIENT A2 (7034))</i>
<i>A3</i>	<i>Value from function (COEFFICIENT A3 (7035))</i>
<i>A4</i>	<i>Value from function (COEFFICIENT A4 (7036))</i>
<i>B1</i>	<i>Value from function (COEFFICIENT B1 (7037))</i>
<i>B2</i>	<i>Value from function (COEFFICIENT B2 (7038))</i>
<i>B3</i>	<i>Value from function (COEFFICIENT B3 (7039))</i>
<i>T</i>	<i>Currently measured temperature in °C</i>

Example:

The following is a concentration table from a reference source.

Temperature	10°C	15°C	20°C	25°C	30°C
<b>Density</b>					
825 kg/m <sup>3</sup>	93.6%	92.5%	91.2%	90.0%	88.7%
840 kg/m <sup>3</sup>	89.3%	88.0%	86.6%	85.2%	83.8%
855 kg/m <sup>3</sup>	84.4%	83.0%	81.5%	80.0%	78.5%
870 kg/m <sup>3</sup>	79.1%	77.6%	76.1%	74.5%	72.9%
885 kg/m <sup>3</sup>	73.4%	71.8%	70.2%	68.6%	66.9%
900 kg/m <sup>3</sup>	67.3%	65.7%	64.0%	62.3%	60.5%
915 kg/m <sup>3</sup>	60.8%	59.1%	57.3%	55.5%	53.7%



Note!

The coefficients for the Promass 83 concentration algorithm should be determined with the density in units of kg/liter, temperature in °C and concentration in decimal form (0.50, not 50%). The coefficients B1, B2 and B3 must be entered in scientific notation into the matrix positions 7037, 7038 and 7039 as a product with 10<sup>-3</sup>, 10<sup>-6</sup> or 10<sup>-9</sup>

Assume:

Density (r): 870 kg/m<sup>3</sup> → 0.870 kg/l

Temperature (T): 20°C

Coefficients determined for table above:

A0 = -2.6057

A1 = 11.642

A2 = -8.8571

A3 = 0

A4 = 0

B1 = -2.7747·10<sup>-3</sup>

B2 = -7.3469·10<sup>-6</sup>

B3 = 0

Calculation:

$$K = A0 + A1 \cdot \rho + A2 \cdot \rho^2 + A3 \cdot \rho^3 + A4 \cdot \rho^4 + B1 \cdot T + B2 \cdot T^2 + B3 \cdot T^3$$

$$= -2.6057 + 11.642 \cdot 0.870 + (-8.8571) \cdot 0.870^2 + 0 \cdot 0.870^3 + 0 \cdot 0.870^4 + (-2.7747) \cdot 10^{-3} \cdot 20 + (-7.3469) \cdot 10^{-6} \cdot 20^2 + 0 \cdot 20^3$$

$$= 0.7604$$

$$= 76.04\%$$

a0004620

*Calculation type "% MASS 2D" or "% VOLUME 2D"*

For this type of calculation, the relationship between the two variables concentration and reference density must be known (2-dimensional), e.g. by a table. In this way, the concentration can be calculated from the measured density and temperature values by means of the following formula (the coefficients A0, A1, etc. have to be determined by the user):

$$K = A0 + A1 \cdot \rho_{\text{ref}} + A2 \cdot \rho_{\text{ref}}^2 + A3 \cdot \rho_{\text{ref}}^3 + A4 \cdot \rho_{\text{ref}}^4$$

a0004621

<i>K</i>	<i>Concentration</i>
<i>rref</i>	<i>Currently measured reference density</i>
<i>A0</i>	<i>Value from function (COEFFICIENT A0 (7032))</i>
<i>A1</i>	<i>Value from function (COEFFICIENT A1 (7033))</i>
<i>A2</i>	<i>Value from function (COEFFICIENT A2 (7034))</i>
<i>A3</i>	<i>Value from function (COEFFICIENT A3 (7035))</i>
<i>A4</i>	<i>Value from function (COEFFICIENT A4 (7036))</i>

**Note!**

Promass determines the reference density by means of the density and temperature currently measured. To do so, both the reference temperature (function REFERENCE TEMPERATURE) and the expansion coefficients (function EXPANSION COEFF) must be entered in the measuring system.

The parameters important for measuring the reference density can also be configured directly via the "Commissioning" Quick Setup menu.

*Calculation type "OTHER 3D" or "OTHER 2D"*

With this option, users can enter a free selectable designation for their specific concentration unit or target parameters (see function TEXT ARBITRARY CONCENTRATION (0606)).

### 6.4.5 Advanced diagnostic functions

Changes to the measuring system, e.g. coating buildup or corrosion and abrasion on the measuring tubes can be detected at an early stage by means of the optional software package "Advanced Diagnostics" (F-Chip, accessories →  85). Normally, these influences reduce the measuring accuracy of the system or may lead to serious system errors.

By means of the diagnostic functions it is now possible to record various process and device parameters during operation, e.g. mass flow, density/reference density, temperature values, measuring tube damping etc.

By analyzing the trend of these measured values, deviations of the measuring system from a "reference status" can be detected in good time and corrective measures can be taken.

#### Reference values as the basis for trend analysis

Reference values of the parameters in question must always be recorded for trend analysis. These reference values are determined under reproducible, constant conditions. Such reference values are initially recorded during calibration at the factory and saved in the measuring device.

Reference data can also be ascertained under customer-specific process conditions, e.g. during commissioning or at certain process stages (cleaning cycles, etc.).

Reference values are recorded and saved in the measuring system always by means of the device function REFERENCE CONDITION USER (7401).



Caution!

It is not possible to analyze the trend of process/device parameters without reference values! Reference values can only be determined under constant, non-changing process conditions.

#### Methods of ascertaining data

Process and device parameters can be recorded in two different ways which you can define in the function ACQUISITION MODE (7410):

- PERIODICAL option: Measuring device acquires data periodically. Enter the desired time interval by means of the function ACQUISITION PERIOD (7411).
- SINGLE SHOT option: The user himself acquires the data manually at different, free selectable periods.

Ensure that the process conditions always correspond to the reference status when data is being recorded. It is only in this way that deviations from the reference status can be clearly determined.



Note!

The last ten entries are retained in chronological order in the measuring system. The "history" of such values can be called up via various functions:

Diagnosis parameters	Data saved (per parameter)
Mass flow	Reference value → REFERENCE VALUE function
Density	Lowest measured value → MINIMUM VALUE function
Reference density	Highest measured value → MAXIMUM VALUE function
Temperature	List of the last ten measured values → HISTORY function
Measuring tube damping	Deviation measured/reference value → ACTUAL DEVIATION function
Sensor symmetry	
Operating frequency fluctuation	
Tube damping fluctuation	
More detailed information can be found in the "Description of Device Functions" manual.	

### Triggering warning messages

If required, a limit value can be assigned to all the process/device parameters relevant to the diagnostic functions. A warning message is triggered if this limit value is exceeded → function WARNING MODE (7403).

The limit value is entered into the measuring system as an absolute (+/-) or relative deviation from the reference value → function WARNING LEVEL (74...).

Deviations arising and recorded by the measuring system can also be output via the current or relay outputs.

### Data interpretation

The way the data recorded by the measuring system is interpreted depends largely on the application in question. This means that users must have a very good knowledge of their specific process conditions and the related deviation tolerances in the process, which have to be determined by the users themselves in each individual case.

For example, when using the limit function it is especially important to know the minimum and maximum deviation tolerances allowed. Otherwise there is the danger that a warning message is triggered inadvertently during "normal" process fluctuations.

There can be various reasons for deviating from the reference status. The following table provides examples and pointers for each of the six diagnosis parameters recorded:

Diagnosis parameters	Possible reasons for deviation
Mass flow	A deviation from the reference status indicates possible zero point shift.
Density	A deviation from the reference status can be caused by a change in the measuring tube resonance frequency, e.g. from deposits in the measuring tube, corrosion or abrasion.
Reference density	The reference density values can be interpreted in the same way as the density values. If the fluid temperature cannot be kept completely constant, you can analyze the reference density (density at a constant temperature, e.g. at 20 °C) instead of the density. Ensure that the parameters required for calculating the reference density have been correctly configured (functions REFERENCE TEMPERATURE and EXPANSION COEFF.).
Temperature	Use this diagnosis parameter to check the functionality of the PT 100 temperature sensor.
Measuring tube damping	A deviation from the reference status can be caused by a change in measuring tube damping, e.g. from mechanical changes (coating buildup, corrosion, abrasion).
Sensor symmetry	Use this diagnosis parameter to determine whether the sensor signals are symmetrical.
Operating frequency fluctuation	A deviation in the operating frequency fluctuation indicates possible gas content in the medium.
Tube damping fluctuation	A deviation in the tube damping fluctuation indicates possible gas content in the medium.

## 6.5 Adjustment

### 6.5.1 Zero point adjustment

All measuring devices are calibrated with state-of-the-art technology. The zero point obtained in this way is printed on the nameplate.

Calibration takes place under reference operating conditions → 111

Consequently, the zero point adjustment is generally **not** necessary!

Experience shows that the zero point adjustment is advisable only in special cases:

- To achieve highest measuring accuracy also at very small flow rates.
- Under extreme process or operating conditions (e.g. very high process temperatures or very high viscosity fluids).

#### Preconditions for a zero point adjustment

Note the following before you perform a zero point adjustment:

- A zero point adjustment can be performed only with fluids that contain no gas or solid contents.
- Zero point adjustment is performed with the measuring tubes completely filled and at zero flow ( $v = 0$  m/s). This can be achieved, for example, with shutoff valves upstream and/or downstream of the sensor or by using existing valves and gates.
  - Normal operation → Valves 1 and 2 open
  - Zero point adjustment *with* pump pressure → Valve 1 open / valve 2 closed
  - Zero point adjustment *without* pump pressure → Valve 1 closed / valve 2 open

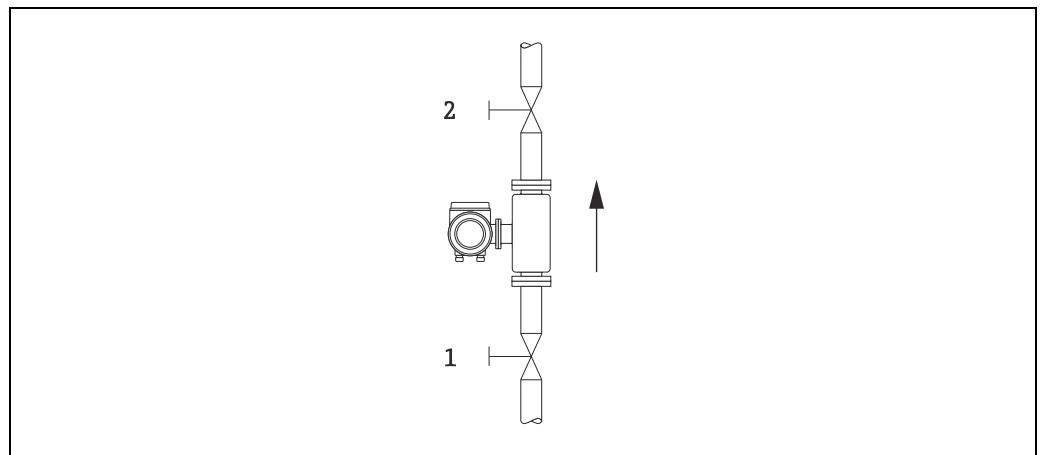

Fig. 45: Zero point adjustment and shutoff valves



















#### Caution!

- If the fluid is very difficult to measure (e.g. containing entrained solids or gas) it may prove impossible to obtain a stable zero point despite repeated zero point adjustments. In instances of this nature, please contact your E+H service center.
- You can view the currently valid zero point value using the ZERO POINT function (see the "Description of Device Functions" manual).

### Performing a zero point adjustment

1. Let the system run until operating conditions have been reached.
2. Stop the flow ( $v = 0$  m/s).
3. Check the shutoff valves for leaks.
4. Check that operating pressure is correct.
5. Perform a zero point adjustment as follows:

Key	Procedure	Display text
	HOME position → Enter the function matrix	> GROUP SELECTION< MEASURED VARIABLES
	Select the BASIC FUNCTION block	> GROUP SELECTION< BASIC FUNCTION
	Select the PROCESS PARAMETER group	> GROUP SELECTION< PROCESS PARAMETER
	Select the ADJUSTMENT function group	> GROUP SELECTION< ADJUSTMENT
	Select the ZERO ADJUST. function	ZERO ADJUST. CANCEL
	After you press  , you are automatically prompted to enter the code if the function matrix is still disabled.	CODE ENTRY ***
	Enter the code (83 = default)	CODE ENTRY 83
	Confirm the code as entered.  The ZERO ADJUST function reappears on the display.	PROGRAMMING ENABLED  ZERO ADJUST. CANCEL
	Select START	ZERO ADJUST. START
	Confirm the entry by pressing the Enter key. The confirmation prompt appears on the display.	SURE? NO
	Select YES.	SURE? YES
	Confirm the entry by pressing the Enter key. Zero point adjustment now starts. While zero point adjustment is in progress, the display shown here is visible for 30 to 60 seconds. If the flow of fluid in the pipe exceeds 0.1 m/s, an error message appears on the display: ZERO ADJUST NOT POSSIBLE.  When the zero point adjustment completes, the ZERO ADJUST. function reappears on the display.	ZERO ADJUST. RUNNING   ZERO ADJUST. CANCEL
	After actuating the Enter key, the new zero point value is displayed.	ZERO POINT
	Simultaneously pressing  → HOME position	



### 6.5.2 Density adjustment

It is advisable to perform a density adjustment when optimum measuring accuracy is required for calculating density dependent values. The application may require a 1-point or 2-point density adjustment.

*1-point density adjustment (with one fluid):*

This type of density adjustment is necessary under the following circumstances:

- The sensor does not measure exactly the density value that the user expects on the basis of laboratory analyses.
- The fluid properties are outside the measuring points set at the factory, or the reference operating conditions used to calibrate the measuring device.
- The system is used exclusively to measure a fluid's density which must be registered to a high degree of accuracy under constant conditions.

Example: Brix density measurement for apple juice.

*2-point density adjustment (with two fluids):*

This type of adjustment is always to be carried out if the measuring tubes have been mechanically altered by, e.g. material buildup, abrasion or corrosion. In such cases, the resonant frequency of the measuring tubes has been affected by these factors and is no longer compatible with the calibration data set at the factory. The 2-point density adjustment takes these mechanically-based changes into account and calculates new, adjusted calibration data.

#### Performing a 1-point or 2-point density adjustment







Caution!

- Onsite density adjustment can be performed only if the user has detailed knowledge of the fluid density, obtained for example from detailed laboratory analyses.
- The target density value specified in this way must not deviate from the measured fluid density by more than  $\pm 10\%$ .
- An error in defining the target density affects all calculated density and volume functions.
- The 2-point density adjustment is only possible if both target density values are different from each other by at least 0.2 kg/l. Otherwise the error message #731 (adjustment is not possible) appears in the "Diag. - Act. Sys. Condition" parameter.
- Density adjustment changes the factory density calibration values or the calibration values set by the service technician.
- The functions outlined in the following instructions are described in detail in the "Description of Device Functions" manual.





1. Fill the sensor with fluid. Make sure that the measuring tubes are completely filled and that liquids are free of gas bubbles.
2. Wait until the temperature difference between fluid and measuring tube has equalized. The time you have to wait for equalization depends on the fluid and the temperature level.
3. Using the local display, select the SETPOINT DENSITY function in the function matrix and perform density adjustment as follows:

Function No.	Function name	Setting to be selected ( $\square$ or $\square$ ) (to next function with $\square$ )
6482	DENSITY ADJUST MODE	Use $\square$ to select a 1- or 2-point adjustment. Note! When you press $\square$ you are automatically prompted to enter the access code if the function matrix is still disabled. Enter the code.
6483	DENSITY SET VALUE 1	Use $\square$ to enter the target density of the first fluid and press $\square$ to save this value (input range = actual density value $\pm 10\%$ ).



Function No.	Function name	Setting to be selected (  or  ) (to next function with  )
6484	MEASURE FLUID 1	Use  to select START and press  . The message "DENSITY MEASUREMENT RUNNING" appears on the display for approximately 10 seconds. During this time Promass measures the current density of the first fluid (measured density value).





For 2-point density adjustment only:

6485	DENSITY SET VALUE 2	Use  to enter the target density of the second fluid and press  to save this value (input range = actual density value $\pm 10\%$ ).
6486	MEASURE FLUID 2	Use  to select START and press  . The message "DENSITY MEASUREMENT RUNNING" appears on the display for approximately 10 seconds. During this time Promass measures the current density of the second fluid (measured density value).



6487	DENSITY ADJUSTMENT	Use  to select DENSITY ADJUSTMENT and press  . Promass compares the measured density value and the target density value and calculates the new density coefficient.
6488	RESTORE ORIGINAL	If the density adjustment does not complete correctly, you can select the RESTORE ORIGINAL function to reactivate the default density coefficient.



Back to the HOME position: → Press and hold down Esc key (  ) for longer than three seconds or → Repeatedly press and release Esc key (  ) → Exit the function matrix step by step		
--	--	--

## 6.6 Purge and pressure monitoring connections

The sensor housing protects the inner electronics and mechanics and is filled with dry nitrogen. Beyond that, up to a specified measuring pressure it additionally serves as secondary containment.



Warning!

For a process pressure above the specified containment pressure, the housing does not serve as an additional secondary containment. In case a danger of measuring tube failure exists due to process characteristics, e.g. with corrosive process fluids, we recommend the use of sensors whose housing is equipped with special pressure monitoring connections (ordering option). With the help of these connections, fluid collected in the housing in the event of tube failure can be drained off. This diminishes the danger of mechanical overload of the housing, which could lead to a housing failure and accordingly is connected with an increased danger potential. These connections can also be used for gas purging (gas detection).

The following instructions apply to handling sensors with purge or pressure monitoring connections:

- Do not open the purge connections unless the containment can be filled immediately with a dry inert gas.
- Use only low gauge pressure to purge. Maximum pressure 5 bar (72,5 psi).

## 6.7 Data memory (HistoROM), F-CHIP

At Endress+Hauser, the term HistoROM refers to various types of data storage modules on which process and measuring device data is stored. By plugging and unplugging such modules, device configurations can be duplicated onto other measuring devices to cite just one example.

### 6.7.1 HistoROM/S-DAT (sensor-DAT)

The S-DAT is an exchangeable data memory in which all sensor relevant parameters are stored, i.e., diameter, serial number, calibration factor, zero point.

### 6.7.2 HistoROM/T-DAT (transmitter-DAT)

The T-DAT is an exchangeable data storage device in which all transmitter parameters and settings are stored.

Storing of specific parameter settings from the EEPROM to the T-DAT and vice versa has to be carried out by the user (= manual save function). Detailed instructions regarding this can be found on → 68.

### 6.7.3 F-CHIP (Function-Chip)

The F-Chip is a microprocessor chip that contains additional software packages that extend the functionality and application possibilities of the transmitter.

In the case of a later upgrade, the F-Chip can be ordered as an accessory and can simply be plugged on to the I/O board. After start up, the software is immediately made available to the transmitter.

Accessories → 85

Plugging on to the I/O board → Page 94 ff.



Caution!

To ensure an unambiguous assignment, the F-CHIP is coded with the transmitter serial number once it is plugged in. Thus, it can not be reused with other measuring devices.

## 7 Maintenance

No special maintenance work is required.

### 7.1 Exterior cleaning

When cleaning the exterior of measuring devices, always use cleaning agents that do not attack the surface of the housing and the seals.

### 7.2 Cleaning with pigs (Promass H, I, S, P)

If pigs are used for cleaning, it is essential to take the inside diameters of measuring tube and process connection into account, see Technical Information →  143.

### 7.3 Replacing seals

Under normal circumstances, fluid wetted seals of the Promass A sensors do not require replacement. Replacement is necessary only in special circumstances, for example if aggressive or corrosive fluids are incompatible with the seal material.



Note!

- The period between changes depends on the fluid properties and on the frequency of cleaning cycles in the case of CIP/SIP cleaning
- Replacement seals (accessories)

## 8 Accessories

Various accessories, which can be ordered separately from Endress+Hauser, are available for the transmitter and the sensor. Detailed information on the order code in question can be obtained from the Endress+Hauser service organization.

### 8.1 Device-specific accessories

Accessory	Description	Order code
Transmitter Proline Promass 83	Transmitter for replacement or for stock. Use the order code to define the following specifications: <ul style="list-style-type: none"> <li>- Approvals</li> <li>- Degree of protection / version</li> <li>- Cable entries,</li> <li>- Display / power supply / operation</li> <li>- Software</li> <li>- Outputs / inputs</li> </ul>	83XXX - XXXXX * * * * *
Inputs/outputs	Conversion kit with appropriate plug-in point modules for converting the input/output configuration in place to date to a new version.	DK8UI - * * * * *
Software packages for - Proline Promass 83	Software add-ons on F-Chip, can be ordered individually: <ul style="list-style-type: none"> <li>- Advanced diagnostics</li> <li>- Batching functions</li> <li>- Concentration measurement</li> </ul>	DK8SO - *

### 8.2 Measuring principle-specific accessories

Accessory	Description	Order code
Mounting set for transmitter	Mounting set for wall-mount housing (remote version). Suitable for: <ul style="list-style-type: none"> <li>- Wall mounting</li> <li>- Pipe mounting</li> <li>- Installation in control panel</li> </ul> Mounting set for aluminum field housing: Suitable for pipe mounting (3/4" to 3")	DK8WM - *
Post mounting set for the Promass A sensor	Post mounting set for the Promass A	DK8AS - **
Mounting set for the Promass A sensor	Mounting set for Promass A, comprising: <ul style="list-style-type: none"> <li>- 2 process connections</li> <li>- Seals</li> </ul>	DK8MS - * * * * *
Set of seals for sensor	For regular replacement of the seals of the Promass A sensors. Set consists of two seals.	DKS - * * *
Memograph M graphic display recorder	The Memograph M graphic display recorder provides information on all the relevant process variables. Measured values are recorded correctly, limit values are monitored and measuring points analyzed. The data are stored in the 256 MB internal memory and also on a DSD card or USB stick. Memograph M boasts a modular design, intuitive operation and a comprehensive security concept. The ReadWin® 2000 PC software is part of the standard package and is used for configuring, visualizing and archiving the data captured. The mathematics channels which are optionally available enable continuous monitoring of specific power consumption, boiler efficiency and other parameters which are important for efficient energy management.	RSG40 - * * * * * * * * *

### 8.3 Communication-specific accessories

Accessory	Description	Order code
HART Communicator Field Xpert handheld terminal	Handheld terminal for remote parameterization and for obtaining measured values via the current output HART (4 to 20 mA).  Contact your Endress +Hauser representative for more information.	SFX100 - *****
FXA195	The Commubox FXA195 connects intrinsically safe smart transmitters with the HART protocol with the USB port of a personal computer. This enables remote operation of the transmitter with operating software (e.g. FieldCare). Power is supplied to the Commubox via the USB port.	FXA195 - *











### 8.4 Service-specific accessories

Accessory	Description	Order code
Applicator	Software for selecting and sizing Endress+Hauser measuring devices: <ul style="list-style-type: none"> <li>▪ Calculation of all the necessary data for identifying the optimum flowmeter: e.g. nominal diameter, pressure loss, accuracy or process connections</li> <li>▪ Graphic illustration of the calculation results</li> </ul> Administration, documentation and access to all project-related data and parameters over the entire life cycle of a project. Applicator is available: <ul style="list-style-type: none"> <li>▪ Via the Internet: <a href="https://wapps.endress.com/applicator">https://wapps.endress.com/applicator</a></li> <li>▪ On CD-ROM for local PC installation.</li> </ul>	DXA80 - *
W@M	Life cycle management for your plant W@M supports you with a wide range of software applications over the entire process: from planning and procurement, to the installation, commissioning and operation of the measuring devices. All the relevant device information, such as the device status, spare parts and device-specific documentation, is available for every device over the entire life cycle. The application already contains the data of your Endress+Hauser device. Endress+Hauser also takes care of maintaining and updating the data records. W@M is available: <ul style="list-style-type: none"> <li>▪ Via the Internet: <a href="http://www.endress.com/lifecyclemanagement">www.endress.com/lifecyclemanagement</a></li> <li>▪ On CD-ROM for local PC installation.</li> </ul>	
Fieldcheck	Tester/simulator for testing flowmeters in the field. When used in conjunction with the "FieldCare" software package, test results can be imported into a database, printed and used for official certification. Contact your Endress+Hauser representative for more information.	50098801
FieldCare	FieldCare is Endress+Hauser's FDT-based plant asset management tool and allows the configuration and diagnosis of intelligent field devices. By using status information, you also have a simple but effective tool for monitoring devices. The Proline flowmeters are accessed via a service interface or via the service interface FXA193.	→ Product page on the Endress+Hauser website: <a href="http://www.endress.com">www.endress.com</a>
FXA193	Service interface from the measuring device to the PC for operation via FieldCare.	FXA193 - *

## 9 Troubleshooting

### 9.1 Troubleshooting instructions

Always start troubleshooting with the following checklist if faults occur after commissioning or during operation. The routine takes you directly to the cause of the problem and the appropriate remedial measures.

Check the display	
No display visible and no output signals present.	<ol style="list-style-type: none"> <li>1. Check the supply voltage → Terminals 1, 2</li> <li>2. Check device fuse →  102 85 to 260 V AC: 0.8 A slow-blow / 250 V 20 to 55 V AC and 16 to 62 V DC: 2 A slow-blow / 250 V</li> <li>3. Measuring electronics defective → order spare parts →  97</li> </ol>
No display visible, but output signals are present.	<ol style="list-style-type: none"> <li>1. Check whether the ribbon-cable connector of the display module is correctly plugged into the amplifier board →  97</li> <li>2. Display module defective → order spare parts →  97</li> <li>3. Measuring electronics defective → order spare parts →  97</li> </ol>
Display texts are in a foreign language.	Switch off power supply. Press and hold down both the  keys and switch on the measuring device. The display text will appear in English (default) and is displayed at maximum contrast.
Measured value indicated, but no signal at the current or pulse output	Measuring electronics defective → order spare parts →  97
▼	
Status signals on display (only HART 7)	
<p>The status signals provide information on the state and reliability of the device by categorizing the cause of the diagnostic information (diagnostic event). The status signals are categorized according to VDI/VDE 2650 and NAMUR Recommendation NE 107: F = Failure, C = Function Check, S = Out of Specification, M= Maintenance Required</p> <p><b>Category F (Failure)</b> A device error has occurred. The measured value is no longer valid.</p> <p><b>Category C (Function check)</b> The device is in service mode (e.g. during a simulation).</p> <p><b>Category S (Out of specification)</b> The device is operated:</p> <ul style="list-style-type: none"> <li>▪ Outside its technical specification limits (e.g. outside the process temperature range)</li> <li>▪ Outside of the configuration carried out by the user (e.g. maximum flow in parameter <b>20 mA value</b>)</li> </ul> <p><b>Category M (Maintenance required)</b> Maintenance is required. The measured value remains valid.</p>	
▼	
Error messages on display	
<p>Errors that occur during commissioning or measuring are displayed immediately. Error messages consist of a variety of icons. The meanings of these icons are as follows (example):</p> <ul style="list-style-type: none"> <li>- Type of error: <b>S</b> = System error, <b>P</b> = Process error</li> <li>- Error message type: <b>!</b> = Fault message, <b>!</b> = Notice message</li> <li>- <b>FLUID INHOM.</b> = Error designation (e.g. fluid is not homogeneous)</li> <li>- <b>03:00:05</b> = Duration of error occurrence (in hours, minutes and seconds)</li> <li>- <b>#702</b> = Error number</li> </ul> <p> Caution! See the information →  37</p>	
▼	
Other error (without error message)	
Some other error has occurred.	Diagnosis and rectification →  95

## 9.2 System error messages

Serious system errors are **always** recognized by the instrument as "Fault message", and are shown as a lightning flash (⚡) on the display!



Caution!

In the event of a serious fault, a flowmeter might have to be returned to the manufacturer for repair. Important procedures must be carried out before you return a flowmeter to Endress+Hauser → 103.

Always enclose a duly completed "Declaration of contamination" form. You will find a preprinted blank of this form at the back of this manual.











Note!



See also the information on → 37.

No.	Error message / Type	Status signals (from the factory, only HART 7)	Cause	Remedy (spare part →  97)
S = System error ⚡ = Fault message (with an effect on the outputs) ! = Notice message (without any effect on the outputs)				
<b>No. # 0xx → Hardware error</b>				
001	S: CRITICAL FAILURE ⚡: # 001	F	Serious device error	Replace the amplifier board.
011	S: AMP HW EEPROM \$: # 011	F	Amplifier: Defective EEPROM	Replace the amplifier board.
012	S: AMP SW EEPROM ⚡: # 012	F	Measuring amplifier; Error when accessing data of the EEPROM	The EEPROM data blocks in which an error has occurred are displayed in the TROUBLESHOOTING function. Press Enter to acknowledge the errors in question; default values are automatically inserted instead of the errored parameter values. Note! The measuring device has to be restarted if an error has occurred in a totalizer block (see also error No. 111 / CHECKSUM TOTAL.).
031	S: SENSOR HW DAT ⚡: # 031	F	1. S-DAT is not plugged into the amplifier board correctly (or is missing). 2. S-DAT is defective.	1. Check whether the S-DAT is correctly plugged into the amplifier board. 2. Replace the S-DAT if it is defective. Check that the new, replacement DAT is compatible with the measuring electronics. Check the: - Spare part set number - Hardware revision code 3. Replace measuring electronics boards if necessary. 4. Plug the S-DAT into the amplifier board.
032	S: SENSOR SW DAT ⚡: # 032	F		
041	S: TRANSM. HW DAT ⚡: # 041	F	1. T-DAT is not plugged into the amplifier board correctly (or is missing). 2. T-DAT is defective.	1. Check whether the T-DAT is correctly plugged into the amplifier board. 2. Replace the T-DAT if it is defective. Check that the new, replacement DAT is compatible with the measuring electronics. Check the: - Spare part set number - Hardware revision code 3. Replace measuring electronics boards if necessary. 4. Plug the T-DAT into the amplifier board.
042	S: TRANSM. SW DAT ⚡: # 042	F		



No.	Error message / Type	Status signals (from the factory, only HART 7)	Cause	Remedy (spare part →  97)
061	S: HW F-CHIP !/: # 061	F	F-Chip transmitter: 1. F-Chip is defective. 2. F-Chip is not plugged into the I/O board or is missing.	1. Replace the F-Chip. Accessories →  85 2. Plug the F-Chip into the I/O board.
<b>No. # 1xx → Software error</b>				
121	S: A / C COMPATIB. !/: # 121	F	Due to different software versions, I/O board and amplifier board are only partially compatible (possibly restricted functionality).  Note! – This message is only listed in the error history. – Nothing is displayed on the display.	Module with lower software version has either to be actualized by FieldCare with the required software version or the module has to be replaced.
<b>No. # 2xx → Error in DAT / no communication</b>				
205	S: LOAD T-DAT !/: # 205	M	Transmitter DAT: Data backup (downloading) to T-DAT failed, or error when accessing (uploading) the calibration values stored in the T-DAT.	1. Check whether the T-DAT is correctly plugged into the amplifier board →  98 →  100 2. Replace the T-DAT if it is defective. Spare parts →  97 Before replacing the DAT, check that the new, replacement DAT is compatible with the measuring electronics. Check the: – Spare part set number – Hardware revision code 3. Replace measuring electronics boards if necessary.
206	S: SAVE T-DAT !/: # 206	M		
251	S: COMMUNICATION I/O !/: # 251	F	Internal communication fault on the amplifier board.	Remove the amplifier board.
261	S: COMMUNICATION I/O !/: # 261	F	No data reception between amplifier and I/O board or faulty internal data transfer.	Check the BUS contacts
<b>No. # 3xx → System limits exceeded</b>				
339 to 342	S: STACK CUR OUT n !/: # 339 to 342	S	The temporarily buffered flow portions (measuring mode for pulsating flow) could not be cleared or output within 60 seconds.	1. Change the upper or lower limit setting, as applicable 2. Increase or reduce flow, as applicable Recommendations in the event of fault category = FAULT MESSAGE (!): – Configure the fault response of the output to ACTUAL VALUE, so that the temporary buffer can be cleared. →  97 – Clear the temporary buffer by the measures described under Item 1.
343 to 346	S: STACK FREQ. OUT n !/: # 343 to 346	S		
347 to 350	S: STACK PULSE OUT n !/: # 347 to 350	S	The temporarily buffered flow portions (measuring mode for pulsating flow) could not be cleared or output within 60 seconds.	1. Increase the setting for pulse weighting 2. Increase the max. pulse frequency, if the totalizer can handle a higher number of pulses. 3. Increase or reduce flow, as applicable. Recommendations in the event of fault category = FAULT MESSAGE (!): – Configure the fault response of the output to ACTUAL VALUE, so that the temporary buffer can be cleared. →  97 – Clear the temporary buffer by the measures described under Item 1.

No.	Error message / Type	Status signals (from the factory, only HART 7)	Cause	Remedy (spare part → 97)
351 to 354	S: CURRENT RANGE n !: # 351 to 354	S	Current output: The actual value for the flow lies outside the set limits.	1. Change the upper or lower limit setting, as applicable 2. Increase or reduce flow, as applicable
355 to 358	S: FREQ. RANGE n !: # 355 to 358	S	Frequency output: The actual value for the flow lies outside the set limits.	1. Change the upper or lower limit setting, as applicable 2. Increase or reduce flow, as applicable
359 to 362	S: PULSE RANGE !: # 359 to 362	S	Pulse output: Pulse output frequency is out of range.	1. Increase the setting for pulse weighting 2. When selecting the pulse width, choose a value that can still be processed by a connected counter (e.g. mechanical counter, PLC etc.). <i>Determine the pulse width:</i> – Version 1: Enter the minimum duration that a pulse must be present at the connected counter to ensure its registration. – Version 2: Enter the maximum (pulse) frequency as the half "reciprocal value" that a pulse must be present at the connected counter to ensure its registration. Example: The maximum input frequency of the connected counter is 10 Hz. The pulse width to be entered is: $\frac{1}{2 \cdot 10 \text{ Hz}} = 50 \text{ ms}$ 3. Reduce flow
363	S: CUR IN. RANGE !: # 363	S	Current input: The actual value for the current lies outside the set limits.	1. Change set lower-range or upper-range value. 2. Check settings of the external sensor.
379 to 380	S: FREQ. LIM !: # 379 to 380	F	The measuring tube oscillation frequency is outside the permitted range.  Causes: – Measuring tube damaged – Sensor defective or damaged	Contact your E+H service organization.
381	S: FLUIDTEMP.MIN. !: # 381	F	The temperature sensor on the measuring tube is likely defective.	Check the following electrical connections before you contact your E+H service organization: – Verify that the sensor signal cable connector is correctly plugged into the amplifier board. – Remote version: Check sensor and transmitter terminal connections No. 9 and 10. → 25
382	S: FLUIDTEMP.MAX. !: # 382	F		
383	S: CARR.TEMP.MIN !: # 383	F	The temperature sensor on the carrier tube is likely defective.	Check the following electrical connections before you contact your E+H service organization: – Verify that the sensor signal cable connector is correctly plugged into the amplifier board. – Remote version: Check sensor and transmitter terminal connections No. 11 and 12. → 25
384	S: CARR.TEMP.MAX !: # 384	F		
385	S: INL.SENS.DEF. !: # 385	F	One of the measuring tube exciter coils (inlet) is likely defective.	Check the following electrical connections before you contact your E+H service organization: – Verify that the sensor signal cable connector is correctly plugged into the amplifier board. – Remote version: Check sensor and transmitter terminal connections No. 4, 5, 6 and 7. → 25
386	S: OUTL.SENS.DEF. !: # 386	F	One of the measuring tube exciter coils (outlet) is likely defective.	
387	S: SEN.ASY.EXCEED !: # 387	F	Measuring pipe excitation coil is probably faulty.	

No.	Error message / Type	Status signals (from the factory, only HART 7)	Cause	Remedy (spare part →  97)
388 to 390	S: AMP. FAULT !/: # 388 to 390	F	Amplifier error	Contact your Endress+Hauser service organization.
<b>No. # 5xx → Application error</b>				
501	S: SW.-UPDATE ACT. !/: # 501	C	New amplifier or communication (I/O module) software version is loaded. Currently no other functions are possible.	Wait until process is finished. The device will restart automatically.
502	S: UP-/DOWNLOAD ACT. !/: # 502	C	Up- or downloading the device data via configuration program. Currently no other functions are possible.	Wait until process is finished.
571	S: BATCH RUNNING !/: # 571	–	Batching is started and active (valves are open).	No measures needed (during the batching process some other functions may not be activated).
572	S: BATCH HOLD !/: # 572	–	Batching has been interrupted (valves are closed).	1. Continue batching with command "GO ON". 2. Interrupt batching with "STOP" command.
586	S: OSC. AMP. LIMIT !/: # 586	F <sup>1)</sup>	The fluid properties do not allow a continuation of the measurement. Causes: – Extremely high viscosity – Process fluid is very inhomogeneous (gas or solid content)	Change or improve process conditions.
587	S: TUBE OSC. NOT !/: # 587	F <sup>1)</sup>	Extreme process conditions exist. The measuring system can therefore not be started.	Change or improve process conditions.
588	S: GAIN RED.IMPOS !/: # 588	F <sup>1)</sup>	Overdriving of the internal analog to digital converter. Causes: – Cavitation – Extreme pressure pulses – High gas flow velocity A continuation of the measurement is no longer possible!	Change or improve process conditions, e.g. by reducing the flow velocity.
<b>No. # 6xx → Simulation mode active</b>				
601	S: POSITIVE ZERO RETURN !/: # 601	C <sup>1)</sup>	Positive zero return active.  Caution! This message has the highest display priority.	Switch off positive zero return.
611 to 614	S: SIM. CURR. OUT. n !/: # 611 to 614	C	Simulation current output active.	
621 to 624	S: SIM. FREQ. OUT n !/: # 621 to 624	C	Simulation frequency output active.	Switch off simulation.
631 to 634	S: SIM. PULSE n !/: # 631 to 634	C	Simulation pulse output active.	Switch off simulation.
641 to 644	S: SIM. STAT. OUT. n !/: # 641 to 644	C	Simulation status output active.	Switch off simulation.
651 to 654	S: SIM. RELAY n !/: # 651 to 654	C	Simulation relay output active.	Switch off simulation.

No.	Error message / Type	Status signals (from the factory, only HART 7)	Cause	Remedy (spare part → 97)
661 to 664	S: SIM. CURR. IN n !: # 661 to 664	C	Simulation current input active.	Switch off simulation.
671 to 674	S: SIM. STAT IN n !: # 671 to 674	C	Simulation status input active.	Switch off simulation.
691	S: SIM. FAILSAFE !: # 691	C	Simulation of response to error (outputs) active.	Switch off simulation.
692	S: SIM. MEASURAND !: # 692	C	Simulation of measuring variables (e.g. mass flow).	Switch off simulation.
698	S: DEV. TEST AKT. !: # 698	C	The measuring device is being checked on site via the test and simulation device.	-
<b>No. # 8xx → Other error messages with software options (Coriolis flowmeter)</b>				
800	S: M. FL. DEV. LIMIT !: # 800	S <sup>1)</sup>	Advanced Diagnostics: The mass flow is outside the limit value, set in the corresponding diagnosis function.	-
801	S: DENS. DEV. LIMIT !: # 801	S <sup>1)</sup>	Advanced Diagnostics: The density is outside the limit value, set in the corresponding diagnosis function.	-
802	S: REF. D. DEV. LIM. !: # 802	S <sup>1)</sup>	Advanced Diagnostics: The reference density is outside the limit value, set in the corresponding diagnosis function.	-
803	S: TEMP. DEV. LIMIT !: # 803	S <sup>1)</sup>	Advanced Diagnostics: The temperature is outside the limit value, set in the corresponding diagnosis function.	-
804	S: T. DAMP DEV. LIM !: # 804	S <sup>1)</sup>	Advanced Diagnostics: The tube damping is outside the limit value, set in the corresponding diagnosis function.	-
805	S: E.D. SEN. DEV. LIM !: # 805	S <sup>1)</sup>	Advanced Diagnostics: The electrodynamic sensor is outside the limit value, set in the corresponding diagnosis function.	-
806	S: F. FLUCT. DEV. LI !: # 806	S <sup>1)</sup>	Advanced Diagnostics: The fluctuation of the operating frequency is outside the limit value set in the corresponding diagnosis functions.	-
807	S: TD FLUCT. DEV. LI !: # 807	S <sup>1)</sup>	Advanced Diagnostics: The fluctuation of the pipe damping is outside the limit value set in the corresponding diagnosis functions.	-
1) Status signal ist changeable				

### 9.3 Process error messages

Process errors can be defined as either "Fault" or "Notice" messages and can thereby be weighted differently. This is specified via the function matrix (→ "Description of Device Functions" manual).



Note!

- The listed error message types below correspond to the factory setting.
- See the information on → 37

No.	Error message / Type	Status signals (from the factory, only HART 7)	Cause	Remedy (spare part→  97)
P = Process error † = Fault message (with an effect on the outputs) ! = Notice message (without any effect on the outputs)				
471	P: > BATCH TIME †: # 471	S	The maximum permitted batching time was exceeded.	1. Increase flow rate. 2. Check valve (opening). 3. Adjust time setting to changed batch quantity. Note! If the errors listed above occur, these are displayed in the Home position flashing continuously. <ul style="list-style-type: none"> <li>■ General:                              These error messages can be reset by configuring any batching parameter. It is sufficient to confirm with the  key and then the  key.</li> <li>■ Batching via status input:                              The error message can be reset by means of a pulse. Another pulse then restarts the batching.</li> <li>■ Batching via operating keys (soft keys)                              The error message is reset by pressing the START key. Pressing the START key a second time starts the batching process.</li> <li>■ Batching via the BATCHING PROCESS function (7260):                              The error message can be reset by pressing the STOP, START, HOLD or GO ON keys. Pressing the START key a second time starts the batching process.</li> </ul>
472	P: << BATCH QUANTITY †: # 472	S	Underbatching: The minimum quantity was not reached.  Overbatching: The maximum permitted batching quantity was exceeded.	Underbatching: 1. Increase fixed correction quantity. 2. 2. Valve closes too quickly with active after run correction. Enter smaller after run as mean value. 3. If the batching quantity changes, the minimum batching quantity must be adjusted.  Overbatching: 1. Reduce fixed correction quantity. 2. Valve closes too slowly with active after run correction. Enter larger after run as mean value. 3. If the batching quantity changes, the maximum batching quantity must be adjusted.  Note! Please observe Note in error message No. 471
473	P: PROGRESS NOTE †: # 473	-	End of filling process approaching. The running filling process has exceeded the predefined batch quantity point for the display warning message.	No measures required (if necessary prepare to replace container).

No.	Error message / Type	Status signals (from the factory, only HART 7)	Cause	Remedy (spare part → 97)
474	P: MAX. FLOW !: # 474	S	Maximum flow value entered is overshoot.	Reduce the flow value.  Note! Please observe Note in error message No. 471
<b>No. # 7xx → Other process errors)</b>				
700	P: EMPTY PIPE !: # 700	S <sup>1)</sup>	The process fluid density is outside the upper or lower limit values set in the EPD function Causes: - Air in the measuring tube - Partly filled measuring tube	1. Ensure that there is no gas content in the process liquid. 2. Adapt the values in the EPD function to the current process conditions.
701	P: EXC. CURR. LIM !: # 701	S <sup>1)</sup>	The maximum current value for the measuring tube exciter coils has been reached, since certain process fluid characteristics are extreme, e.g. high gas or solid content. The instrument continues to work correctly.	In particular with outgassing fluids and/or increased gas content, the following measures are recommended to increase system pressure: 1. Install the instrument at the outlet side of a pump. 2. Install the instrument at the lowest point of an ascending pipeline.
702	P: FLUID INHOM. !: # 702	S <sup>1)</sup>	Frequency control is not stable, due to inhomogeneous process fluid, e.g. gas or solid content.	3. Install a flow restriction, e.g. reducer or orifice plate, downstream from the instrument.
703	P: NOISE LIM. CHO !: # 703	S <sup>1)</sup>	Overdriving of the internal analog to digital converter.	Change or improve process conditions, e.g. by reducing the flow velocity.
704	P: NOISE LIM. CH1 !: # 704	S <sup>1)</sup>	Causes: - Cavitation - Extreme pressure pulses - High gas flow velocity A continuation of the measurement is still possible!	
705	P: FLOW LIMIT f: # 705	S <sup>1)</sup>	The mass flow is too high. The electronics' measuring range will be exceeded.	Reduce flow
731	P: ZERO-ADJ FAIL !: # 731	M	The zero point adjustment is not possible or has been cancelled.	Make sure that zero point adjustment is carried out at "zero flow" only (v = 0 m/s) → 79
1) Status signal ist changeable				

## 9.4 Process errors without messages

Symptoms	Rectification
<p>Comment: You may have to change or correct certain settings of the function matrix in order to rectify faults. The functions outlined below, such as DISPLAY DAMPING, for example, are described in detail in the "Description of Device Functions" manual.</p>	
Measured value reading fluctuates even though flow is steady.	<ol style="list-style-type: none"> <li>1. Check the fluid for presence of gas bubbles.</li> <li>2. TIME CONSTANT function → increase value (→ OUTPUTS / CURRENT OUTPUT / CONFIGURATION)</li> <li>3. DISPLAY DAMPING function → increase value (→ USER INTERFACE / CONTROL / BASIC CONFIGURATION)</li> </ol>
Flow values are negative, even though the fluid is flowing forwards through the pipe.	Change the INSTALLATION DIR. SENSOR function accordingly
Measured-value reading or measured-value output pulsates or fluctuates, e.g. because of reciprocating pump, peristaltic pump, diaphragm pump or pump with similar delivery characteristic.	<p>Run the "Pulsating Flow" Quick Setup. → 59</p> <p>If the problem persists despite these measures, a pulsation damper will have to be installed between pump and measuring device.</p>
There are differences between the flowmeter's internal totalizer and the external metering device.	<p>This symptom is due primarily to backflow in the piping, because the pulse output cannot subtract in the "STANDARD" or "SYMMETRY" measuring modes.</p> <p>The problem can be solved as follows: Allow for flow in both directions. Set the MEASURING MODE function to "Pulsating Flow" for the pulse output in question.</p>
Measured value reading shown on display, even though the fluid is at a standstill and the measuring tube is full.	<ol style="list-style-type: none"> <li>1. Check the fluid for presence of gas bubbles.</li> <li>2. Activate the ON-VAL. LF-CUTOFF function, i.e. enter or increase the value for the low flow cut off (→ BASIC FUNCTION / PROCESS PARAMETER / CONFIGURATION).</li> </ol>
<p>The error cannot be eliminated or another error pattern is present.</p> <p>In instances of this nature, contact your E+H service organization.</p>	<p>The following solutions are possible:</p> <p><b>Request the services of an Endress+Hauser service technician</b> If you request the services of a service technician, please be ready with the following information:</p> <ul style="list-style-type: none"> <li>– Brief error description</li> <li>– Nameplate specifications: order code and serial number → Page 8 ff.</li> </ul> <p><b>Return the devices to Endress+Hauser</b> Procedures must be carried out before you return a flowmeter to Endress+Hauser for repair or calibration. Please see → 103. Always enclose a duly completed "Declaration of contamination" form with the flowmeter. You will find a master copy of the Dangerous Goods Sheet at the back of these Operating Instructions.</p> <p><b>Replace the transmitter electronics</b> Parts of the measuring electronics defective → order spare part → 97</p>

## 9.5 Response of outputs to errors



**Note!**

The failsafe mode of totalizers, current, pulse and frequency outputs can be customized by means of various functions in the function matrix. You will find detailed information on these procedures in the "Description of Device Functions" manual.

You can use positive zero return to set the signals of the current, pulse and status outputs to their fallback value, for example when measuring has to be interrupted while a pipe is being cleaned. This function takes priority over all other device functions. Simulations, for example, are suppressed.

Failsafe mode of outputs and totalizers		
	Process/system error is present	Positive zero return is activated
<b>Caution!</b> System or process errors defined as "Notice messages" have no effect whatsoever on the inputs and outputs. See the information on → 37		
Current output	<b>MIN. CURRENT</b> The current output will be set to the lower value of the signal on alarm level depending on the setting selected in the CURRENT SPAN (see the "Description of Device Functions" manual). <b>MAX. CURRENT</b> The current output will be set to the higher value of the signal on alarm level depending on the setting selected in the CURRENT SPAN (see the "Description of Device Functions" manual). <b>HOLD VALUE</b> Measured value display on the basis of the last saved value preceding occurrence of the fault. <b>ACTUAL VALUE</b> Measured value display on the basis of the current flow measurement. The fault is ignored.	Output signal corresponds to "zero flow"
Pulse output	<b>FALLBACK VALUE</b> Signal output → no pulses <b>HOLD VALUE</b> Last valid value (preceding occurrence of the fault) is output. <b>ACTUAL VALUE</b> Fault is ignored, i.e. normal measured value output on the basis of ongoing flow measurement.	Output signal corresponds to "zero flow"
Frequency output	<b>FALLBACK VALUE</b> Signal output → 0 Hz <b>FAILSAFE VALUE</b> Output of the frequency specified in the FAILSAFE VALUE function. <b>HOLD VALUE</b> Last valid value (preceding occurrence of the fault) is output. <b>ACTUAL VALUE</b> Fault is ignored, i.e. normal measured value output on the basis of ongoing flow measurement.	Output signal corresponds to "zero flow"
Totalizer	<b>STOP</b> The totalizers are paused until the error is rectified. <b>ACTUAL VALUE</b> The fault is ignored. The totalizer continues to count in accordance with the current flow value. <b>HOLD VALUE</b> The totalizers continue to count the flow in accordance with the last valid flow value (before the error occurred).	Totalizer stops
Relay output	In event of fault or power supply failure: relay → de-energized  The "Description of Device Functions" manual contains detailed information on relay switching response for various configurations such as error message, flow direction, EPD, full scale value, etc.	No effect on the relay output



## 9.6 Spare parts

The previous sections contain a detailed troubleshooting guide → Page 84 ff. The measuring device, moreover, provides additional support in the form of continuous self-diagnosis and error messages.

Fault rectification can entail replacing defective components with tested spare parts. The illustration below shows the available scope of spare parts.



Note!

You can order spare parts directly from your Endress+Hauser service organization by providing the serial number printed on the transmitter's nameplate → 7.

Spare parts are shipped as sets comprising the following parts:

- Spare part
- Additional parts, small items (threaded fasteners, etc.)
- Mounting instructions
- Packaging

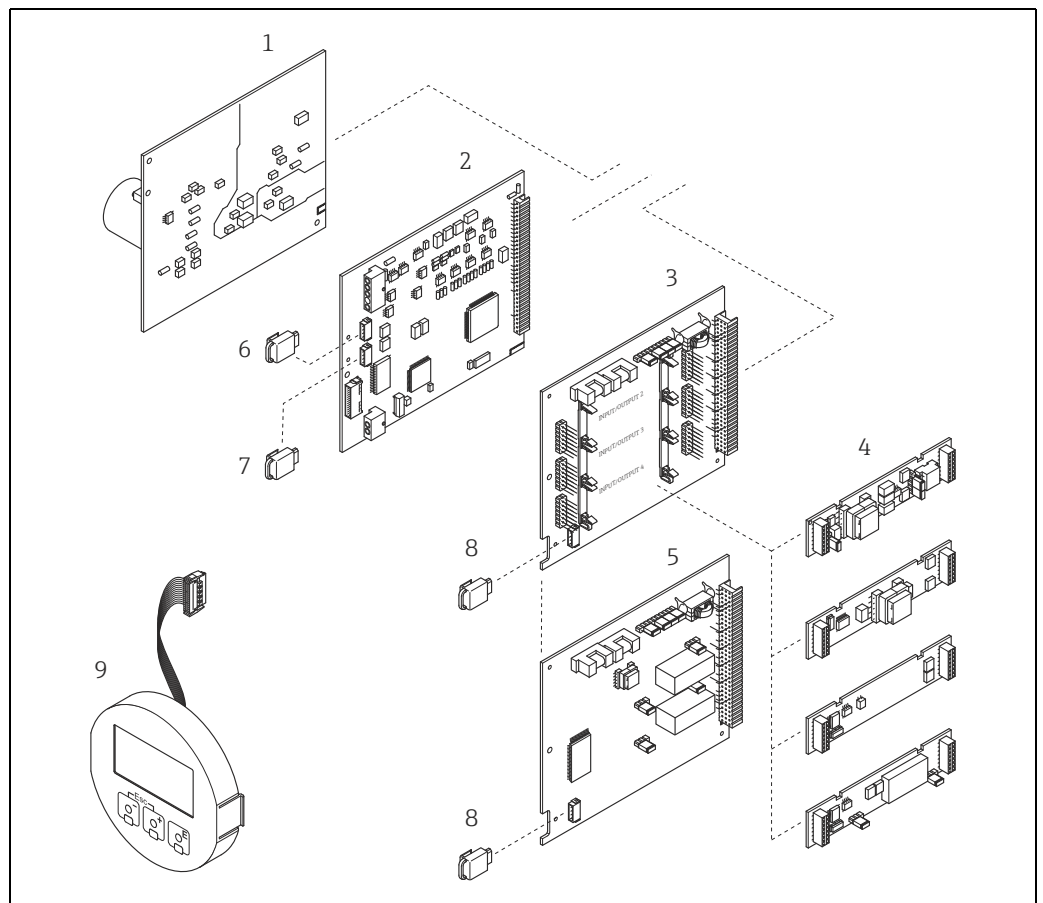

Fig. 46: Spare parts for transmitter 83 (field and wall-mount housings)

- 1 Power unit board (85 to 260 V AC, 20 to 55 V AC, 16 to 62 V DC)
- 2 Amplifier board
- 3 I/O board (COM module), flexible assignment
- 4 Pluggable input/output submodules; ordering structure → Page 82 ff.
- 5 I/O board (COM module), permanent assignment
- 6 S-DAT (sensor data memory)
- 7 T-DAT (transmitter data memory)
- 8 F-Chip (function chip for optional software)
- 9 Display module

## 9.6.1 Removing and installing printed circuit boards

### Field housing



#### Warning!

- Risk of electric shock. Exposed components carry dangerous voltages. Make sure that the power supply is switched off before you remove the cover of the electronics compartment.
- Risk of damaging electronic components (ESD protection). Static electricity can damage electronic components or impair their operability. Use a workplace with a grounded working surface purposely built for electrostatically sensitive devices!
- If you cannot guarantee that the dielectric strength of the device is maintained in the following steps, then an appropriate inspection must be carried out in accordance with the manufacturer's specifications.



#### Caution!

Use only original Endress+Hauser parts.

→  47, installation and removal:

1. Unscrew cover of the electronics compartment from the transmitter housing.
2. Remove the local display (1) as follows:
  - Press in the latches (1.1) at the side and remove the display module.
  - Disconnect the ribbon cable (1.2) of the display module from the amplifier board.
3. Remove the screws and remove the cover (2) from the electronics compartment.
4. Remove power unit board (4) and I/O board (6, 7):  
Insert a thin pin into the hole (3) provided for the purpose and pull the board clear of its holder.
5. Remove submodules (6.1):  
No tools are required for removing the submodules (inputs/outputs) from the I/O board. Installation is also a no-tools operation.



#### Caution!

Only certain combinations of submodules on the I/O board are permissible. →  28

The individual slots are marked and correspond to certain terminals in the connection compartment of the transmitter:

Slot "INPUT / OUTPUT 2" = Terminals 24 / 25

Slot "INPUT / OUTPUT 3" = Terminals 22 / 23

Slot "INPUT / OUTPUT 4" = Terminals 20 / 21

6. Remove amplifier board (5):
  - Disconnect the plug of the sensor signal cable (5.1) including S-DAT (5.3) from the board.
  - Gently disconnect the plug of the excitation current cable (5.2) from the board, i.e. without moving it back and forward.
  - Insert a thin pin into the hole (3) provided for the purpose and pull the board clear of its holder.
7. Installation is the reverse of the removal procedure.

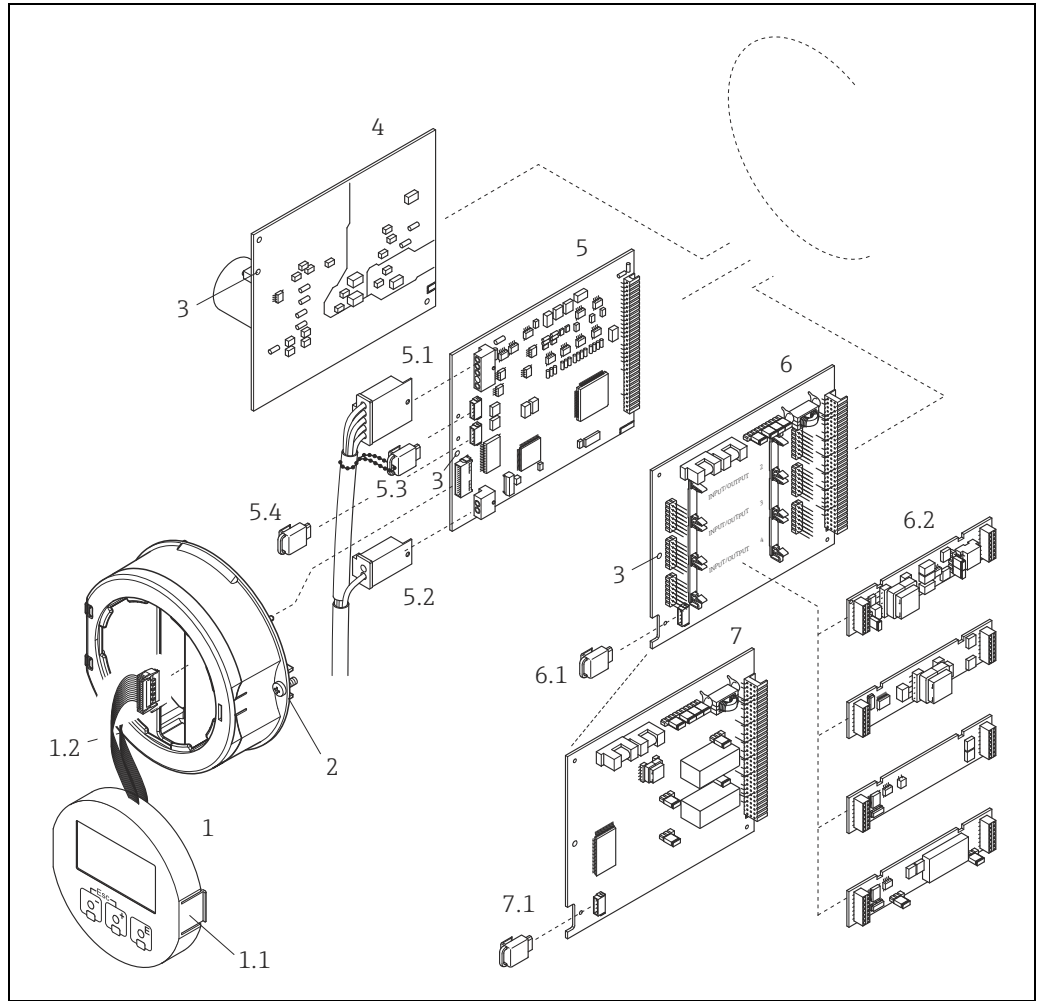

a0004600

Fig. 47: Field housing: removing and installing printed circuit boards

- 1 Local display
- 1.1 Latch
- 1.2 Ribbon cable (display module)
- 2 Screws of electronics compartment cover
- 3 Aperture for installing/removing boards
- 4 Power unit board
- 5 Amplifier board
- 5.1 Signal cable (sensor)
- 5.2 Excitation current cable (sensor)
- 5.3 S-DAT (sensor data memory)
- 5.4 T-DAT (transmitter data memory)
- 6 I/O board (flexible assignment)
- 6.1 F-Chip (function chip for optional software)
- 6.2 Pluggable submodules (status input and current input, current output, frequency output and relay output)
- 7 I/O board (permanent assignment)
- 7.1 F-Chip (function chip for optional software)

### Wall-mount housing



#### Warning!

- Risk of electric shock. Exposed components carry dangerous voltages. Make sure that the power supply is switched off before you remove the cover of the electronics compartment.
- Risk of damaging electronic components (ESD protection). Static electricity can damage electronic components or impair their operability. Use a workplace with a grounded working surface purposely built for electrostatically sensitive devices!
- If you cannot guarantee that the dielectric strength of the device is maintained in the following steps, then an appropriate inspection must be carried out in accordance with the manufacturer's specifications.



#### Caution!

Use only original Endress+Hauser parts.

→  48, installation and removal:

1. Remove the screws and open the hinged cover (1) of the housing.
2. Loosen the screws securing the electronics module (2). Then push up electronics module and pull it as far as possible out of the wall-mount housing.
3. Disconnect the following cable plugs from amplifier board (7):
  - Sensor signal cable plug (7.1) including S-DAT (7.3)
  - Unplug excitation current cable (7.2). Gently disconnect the plug, i.e. without moving it back and forward.
  - Ribbon cable plug (3) of the display module.
4. Remove the cover (4) from the electronics compartment by loosening the screws.
5. Remove the boards (6, 7, 8, 9):  
Insert a thin pin into the hole (5) provided for the purpose and pull the board clear of its holder.
6. Remove submodules (8.1):  
No tools are required for removing the submodules (inputs/outputs) from the I/O board. Installation is also a no-tools operation.



#### Caution!

Only certain combinations of submodules on the I/O board are permissible. →  28  
The individual slots are marked and correspond to certain terminals in the connection compartment of the transmitter:

Slot "INPUT / OUTPUT 2" = Terminals 24 / 25

Slot "INPUT / OUTPUT 3" = Terminals 22 / 23

Slot "INPUT / OUTPUT 4" = Terminals 20 / 21

7. Installation is the reverse of the removal procedure.

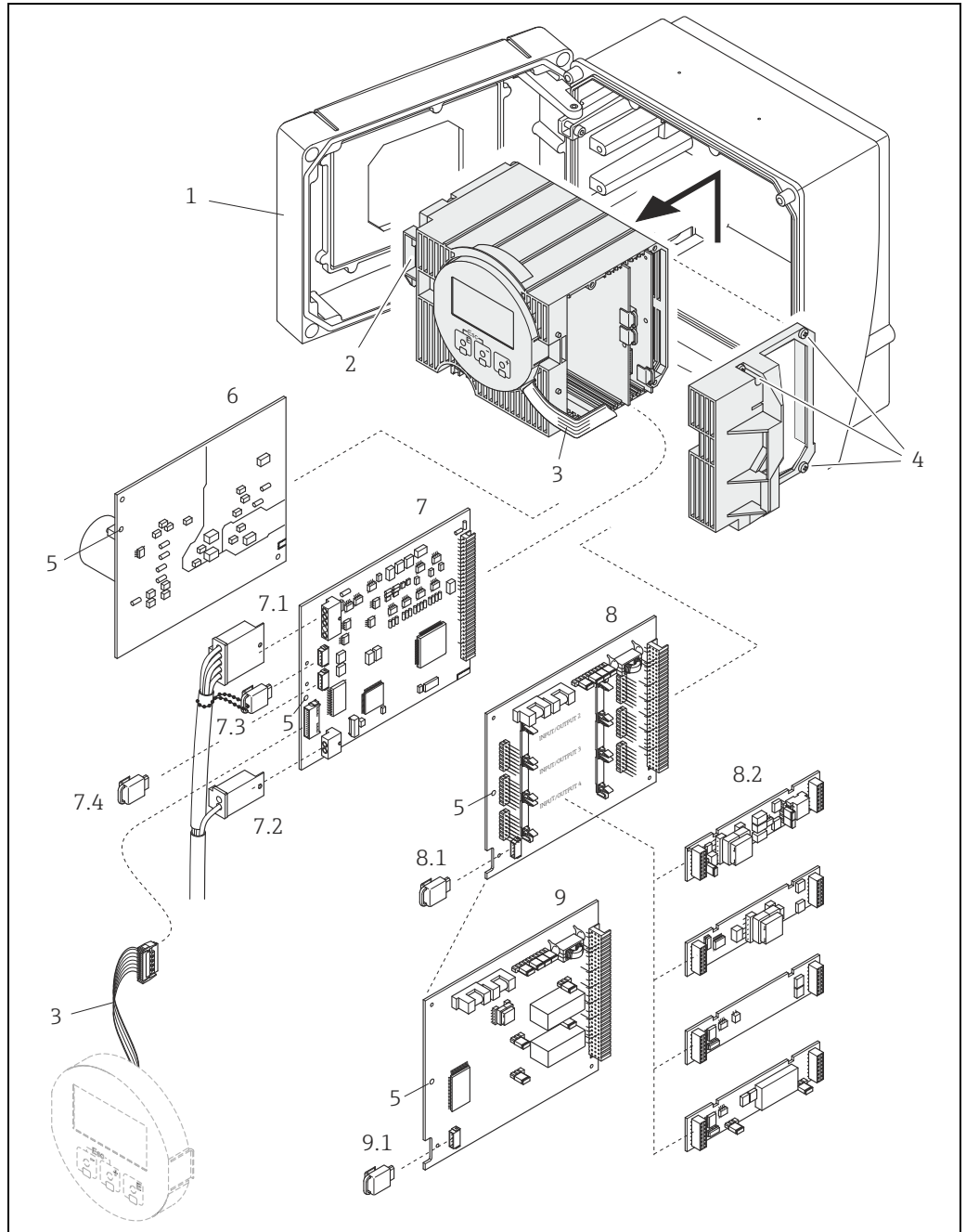

Fig. 48: Wall-mount housing: removing and installing printed circuit boards

- 1 Housing cover
- 2 Electronics module
- 3 Ribbon cable (display module)
- 4 Screws of electronics compartment cover
- 5 Aperture for installing/removing boards
- 6 Power unit board
- 7 Amplifier board
- 7.1 Signal cable (sensor)
- 7.2 Excitation current cable (sensor)
- 7.3 S-DAT (sensor data memory)
- 7.4 T-DAT (transmitter data memory)
- 8 I/O board (flexible assignment)
- 8.1 F-Chip (function chip for optional software)
- 8.2 Pluggable submodules (status input and current input, current output, frequency output and relay output)
- 9 I/O board (permanent assignment)
- 9.1 F-Chip (function chip for optional software)

### 9.6.2 Replacing the device fuse



**Warning!**

Risk of electric shock. Exposed components carry dangerous voltages. Make sure that the power supply is switched off before you remove the cover of the electronics compartment.

The main fuse is on the power unit board → 49.

The procedure for replacing the fuse is as follows:

1. Switch off power supply.
2. Remove the power unit board. → 98 → 100
3. Remove the protection cap (1) and replace the device fuse (2).  
Only use the following fuse type:
  - 20 to 55 V AC / 16 to 62 V DC → 2.0 A slow-blow / 250 V; 5.2 × 20 mm
  - Power supply 85 to 260 V AC → 0.8 A slow-blow / 250 V; 5.2 × 20 mm
  - Ex-rated devices → see the Ex documentation
4. Installation is the reverse of the removal procedure.



**Caution!**

Use only original Endress+Hauser parts.

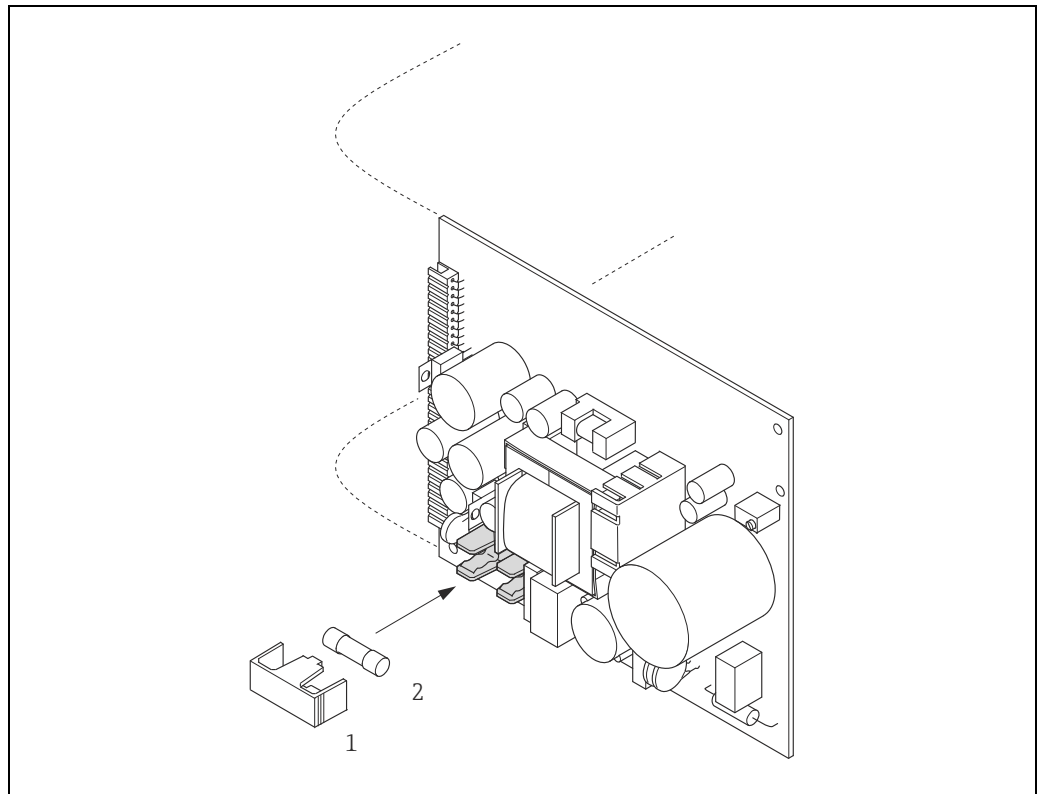

a0001148

Fig. 49: Replacing the device fuse on the power unit board

- 1 Protective cap
- 2 Device fuse

## 9.7 Return



### Caution!

Do not return a measuring device if you are not absolutely certain that all traces of hazardous substances have been removed, e.g. substances which have penetrated crevices or diffused through plastic.

Costs incurred for waste disposal and injury (burns, etc.) due to inadequate cleaning will be charged to the owner-operator.

The following steps must be taken before returning a flow measuring device to Endress+Hauser, e.g. for repair or calibration:

- Always enclose a duly completed "Declaration of contamination" form. Only then can Endress+Hauser transport, examine and repair a returned device.
- Enclose special handling instructions if necessary, for example a safety data sheet as per EC REACH Regulation No. 1907/2006.
- Remove all residues. Pay special attention to the grooves for seals and crevices which could contain residues. This is particularly important if the substance is hazardous to health, e.g. flammable, toxic, caustic, carcinogenic, etc.



### Note!

You will find a preprinted "Declaration of contamination" form at the back of these Operating Instructions.

## 9.8 Disposal

Observe the regulations applicable in your country!

## 9.9 Software history



### Note!

Up or downloading a software version normally requires a special service software.

Date	Software version	Changes to software	Documentation
12.2014	3.07.XX	Software expansion: <ul style="list-style-type: none"> <li>▪ Status signals according VDI/VDE 2650 and NAMUR Recommendation NE 107</li> <li>▪ Introduction HART 7               <ul style="list-style-type: none"> <li>- New functionalities</li> <li>- New Universal / Common practice HART commands</li> <li>- Amplifier update</li> </ul> </li> </ul>	71230715/15.14
10.2012	3.01.XX	-	71197481/14.12
09.2011	3.01.XX	New Sensor: Promass O, Promass X	71141441/13.11
01.2010		New functionalities: <ul style="list-style-type: none"> <li>- Calibration history</li> <li>- Life zero</li> </ul>	71111272/03.10
06.2008	3.00.00	<ul style="list-style-type: none"> <li>- New amplifier hardware.</li> <li>- Enhanced gas measuring range.</li> <li>- New SIL evaluation</li> </ul>	71082621/09.08
12.2006	2.02.00	New Sensor: Promass S, Promass P	71036077/12.06
11.2005	2.01.XX	Software expansion: <ul style="list-style-type: none"> <li>- Promass I DN80, DN50FB</li> <li>- Additional functionalities for "Advanced Diagnosis"</li> <li>- Additional functionalities for "Batching"</li> <li>- General instrument functions</li> </ul>	71008485/12.05

Date	Software version	Changes to software	Documentation
11.2004	2.00.XX	Software expansion: – Assignment of reference density to the current input – HART Command #3 extends functionalities for F-Chip (e.g. density functions) – New sensor DN 250 – Chinese language package (English and Chinese contents)  New functionalities: – Empty pipe detection via exciting current (EPD EXC.CURR. (6426)) – Extension with batching option: MAX.FLOW (7244) → Maximum flow exceeded during batching BATCH TIME (7283) → Dosing time exceeded – DEVICE SOFTWARE (8100) → Device software displayed (NAMUR Recommendation 53) – REMOVE SW OPTION (8006) → remove F-CHIP options	50098469/11.04
10.2003	Amplifier: 1.06.XX Communication module: 1.03.XX	Software expansion: – Language groups – Flow direction pulse output selectable – Adjustments to Fieldcheck and Simubox – Concentration measurement with 4 data records – Viscosity measurement with temperature compensation – Acquisition start via status input for advanced diagnostics – SIL 2  New functionalities: – Operation hours counter – Intensity of background illumination adjustable – Simulation pulse output – Counter for access code – Current input  Compatible with: – ToF-Tool FieldTool Package – HART Communicator DXR 375 With Device Rev. 5, DD Rev. 1	50098469/10.03
03.2003	Amplifier: 1.05.XX Communication module: 1.02.XX	Software adjustment	50098469/03.03
08.2002	Amplifier: 1.04.XX Communication module: 1.02.XX	Software expansion: – Promass H – Promass E	50098469/08.02
06.2001	Amplifier: 1.02.XX Communication module: 1.02.XX	Software expansion: – General instrument functions – "Batching" software function – "Pulse width" software function – "Concentration measurement" software function – "Advanced Diagnostics" software function – HART operating via Universal Commands and Common Practice Commands	50098469/06.01
03.2001	Amplifier: 1.01.XX Communication module: 1.01.XX	Software adjustment	50098469/11.00



---

Date	Software version	Changes to software	Documentation
11.2000	Amplifier: 1.00.XX Communication module: 1.01.XX	Original software Compatible with: – Fieldtool – HART Communicator DXR 275 (as of OS 4.6) with Rev. 1, DD 1.	50098469/11.00

## 10 Technical data

### 10.1 Applications

→  4

### 10.2 Function and system design

Measuring principle      Mass flow measurement by the Coriolis principle

Measuring system      →  6

### 10.3 Input

Measured variable

- Mass flow (proportional to the phase difference between two sensors mounted on the measuring tube to register a phase shift in the oscillation)
- Fluid density (proportional to resonance frequency of the measuring tube)
- Fluid temperature (measured with temperature sensors)

Measuring range      **Measuring ranges for liquids**

DN		Range for full scale values (liquids) $\dot{m}_{\min(F)}$ to $\dot{m}_{\max(F)}$	
[mm]	[inch]	[kg/h]	[lb/min]
1	1/24	0 to 20	0 to 0.735
2	1/12	0 to 100	0 to 3.675
4	1/8	0 to 450	0 to 16.54
8	3/8	0 to 2000	0 to 73.50
15	½	0 to 6500	0 to 238.9
15 FB	½ FB	0 to 18000	0 to 661.5
25	1	0 to 18000	0 to 661.5
25 FB	1 FB	0 to 45000	0 to 1654
40	1 ½	0 to 45000	0 to 1654
40 FB	1 ½ FB	0 to 70000	0 to 2573
50	2	0 to 70000	0 to 2573
50 FB	2 FB	0 to 180000	0 to 6615
80	3	0 to 180000	0 to 6615
100	4	0 to 350000	0 to 12860
150	6	0 to 800000	0 to 29400
250	10	0 to 2200000	0 to 80850
350	14	0 to 4100000	0 to 150675

FB = Full bore versions of Promass I

**Measuring ranges for gases, general, (except Promass H (Zr))**

The full scale values depend on the density of the gas. Use the formula below to calculate the full scale values:

$$\dot{m}_{\max(G)} = \dot{m}_{\max(F)} \times r_{(G)} : x \text{ [kg/m}^3 \text{ (lb/ft}^3\text{)]}$$

$\dot{m}_{\max(G)}$  = Max. full scale value for gas [kg/h (lb/min)]

$\dot{m}_{\max(F)}$  = Max. full scale value for liquid [kg/h (lb/min)]

$r_{(G)}$  = Gas density in [kg/m<sup>3</sup> (lb/ft<sup>3</sup>)] for process conditions

Here,  $\dot{m}_{\max(G)}$  can never be greater than  $\dot{m}_{\max(F)}$

**Measuring ranges for gases (Promass F, O):**

DN		x
[mm]	[inch]	
8	3/8	60
15	½	80
25	1	90
40	1½	90
50	2	90
80	3	110
100	4	130
150	6	200
250	10	200

**Measuring ranges for gases (Promass E)**

DN		x
[mm]	[inch]	
8	3/8	85
15	½	110
25	1	125
40	1½	125
50	2	125
80	3	155

**Measuring ranges for gases (Promass P, S, H (Ta))**

DN		x
[mm]	[inch]	
8	3/8	60
15	½	80
25	1	90
40 <sup>1)</sup>	1½ <sup>1)</sup>	90
50 <sup>1)</sup>	2 <sup>1)</sup>	90

<sup>1)</sup> only Promass P, S

**Measuring ranges for gases (Promass A)**

DN		x
[mm]	[inch]	
1	1/24	32
2	1/12	32
4	1/8	32

**Measuring ranges for gases (Promass I)**

DN		x
[mm]	[inch]	
8	3/8	60
15	1/2	80
15 FB	1/2 FB	90
25	1	90
25 FB	1 FB	90
40	1 1/2	90
40 FB	1 1/2 FB	90
50	2	90
50 FB	2 FB	110
80	3	110

FB = Full bore versions of Promass I

**Measuring ranges for gases (Promass X)**

DN		x
[mm]	[inch]	
350	14	200

Calculation example for gas:

- Sensor type: Promass F, DN 50
- Gas: air with a density of 60.3 kg/m<sup>3</sup> (at 20 °C and 50 bar)
- Measuring range (liquid): 70000 kg/h
- x = 90 (for Promass F DN 50)

Max. possible full scale value:

$$\dot{m}_{\max(G)} = \dot{m}_{\max(F)} \cdot r_{(G)} \div x \text{ [kg/m}^3\text{]} = 70000 \text{ kg/h} \cdot 60.3 \text{ kg/m}^3 \div 90 \text{ kg/m}^3 = 46900 \text{ kg/h}$$

Recommended full scale values

See → Page 127 ff. ("Limiting flow")

Operable flow range

Greater than 1000 : 1. Flows above the preset full scale value do not overload the amplifier, i.e. totalizer values are registered correctly.

Input signal	<p><b>Status input (auxiliary input):</b>  <math>U = 3</math> to <math>30</math> V DC, <math>R_i = 5</math> kW, galvanically isolated.  Configurable for: totalizer reset, positive zero return, error message reset, start zero point adjustment, batching start/stop (optional)</p> <p><b>Current input:</b>  Active/passive selectable, galvanically isolated, resolution: <math>2 \mu\text{A}</math></p> <ul style="list-style-type: none"> <li>▪ Active: <math>4</math> to <math>20</math> mA, <math>R_L &lt; 700</math> W, <math>U_{\text{out}} = 24</math> V DC, short-circuit proof</li> <li>▪ Passive: <math>0/4</math> to <math>20</math> mA, <math>R_i = 150</math> W, <math>U_{\text{max}} = 30</math> V DC</li> </ul>
<b>10.4 Output</b>	
Output signal	<p><b>Current output:</b>  Active/passive selectable, galvanically isolated, time constant selectable (<math>0.05</math> to <math>100</math> s), full scale value selectable, temperature coefficient: typically <math>0.005\%</math> of full scale value/<math>^{\circ}\text{C}</math>, resolution: <math>0.5</math> mA</p> <ul style="list-style-type: none"> <li>▪ Active: <math>0/4</math> to <math>20</math> mA, <math>R_L &lt; 700</math> W (for HART: <math>R_L \geq 250</math> W)</li> <li>▪ Passive: <math>4</math> to <math>20</math> mA; supply voltage <math>U_s</math> <math>18</math> to <math>30</math> V DC; <math>R_i \geq 150</math> W</li> </ul> <p><b>Pulse/frequency output:</b>  Active/passive selectable, galvanically isolated</p> <ul style="list-style-type: none"> <li>▪ Active: <math>24</math> V DC, <math>25</math> mA (max. <math>250</math> mA during <math>20</math> ms), <math>R_L &gt; 100</math> W</li> <li>▪ passive: open collector, <math>30</math> V DC, <math>250</math> mA</li> <li>▪ Frequency output: full scale frequency <math>2</math> to <math>10000</math> Hz (<math>f_{\text{max}} = 12500</math> Hz), on/off ratio <math>1:1</math>, pulse width max. <math>2</math> s</li> <li>▪ Pulse output: pulse value and pulse polarity selectable, pulse width configurable (<math>0.05</math> to <math>2000</math> ms)</li> </ul>
Signal on alarm	<p><i>Current output:</i>  Failsafe mode selectable (for example, according to NAMUR Recommendation NE 43)</p> <p><i>Pulse/frequency output:</i>  Failsafe mode selectable</p> <p><i>Relay output:</i>  De-energized in the event of fault or power supply failure</p>
Load	See "Output signal"
Switching output	<p><b>Relay output:</b>  Normally closed (NC or break) or normally open (NO or make) contacts available (default: relay 1 = NO, relay 2 = NC), max. <math>30</math> V / <math>0.5</math> A AC; <math>60</math> V / <math>0.1</math> A DC, galvanically isolated.  Configurable for: error messages, Empty Pipe Detection (EPD), flow direction, limit values, batching valve 1 and 2 (optional).</p>
Low flow cut off	Switch points for low flow cut off are selectable.
Galvanic isolation	All circuits for inputs, outputs, and power supply are galvanically isolated from each other.

## 10.5 Power supply

Electrical connections	→ Page 25 ff.
Supply voltage	85 to 260 V AC, 45 to 65 Hz 20 to 55 V AC, 45 to 65 Hz 16 to 62 V DC
Power consumption	AC: <15 VA (including sensor) DC: <15 W (including sensor)  <i>Switch-on current:</i> <ul style="list-style-type: none"> <li>■ max. 13.5 A (&lt; 50 ms) at 24 V DC</li> <li>■ max. 3 A (&lt; 5 ms) at 260 V AC</li> </ul>
Power supply failure	Lasting min. 1 power cycle: <ul style="list-style-type: none"> <li>■ EEPROM and T-DAT save measuring system data if power supply fails.</li> <li>■ HistoROM/S-DAT: exchangeable data storage chip which stores the data of the sensor (nominal diameter, serial number, calibration factor, zero point, etc.)</li> </ul>
Potential equalization	No measures necessary.
Cable entries	<i>Power supply and signal cables (inputs/outputs):</i> <ul style="list-style-type: none"> <li>■ Cable entry M20 × 1.5 (8 to 12 mm / 0.31 to 0.47 inch)</li> <li>■ Threads for cable entries, 1/2" NPT, G 1/2"</li> </ul> <i>Connecting cable for remote version:</i> <ul style="list-style-type: none"> <li>■ Cable entry M20 × 1.5 (8 to 12 mm / 0.31 to 0.47 inch)</li> <li>■ Threads for cable entries, 1/2" NPT, G 1/2"</li> </ul>
Cable specifications remote version	Remote version →  26

## 10.6 Performance characteristics

Reference operating conditions

- Error limits following ISO/DIN 11631
- Water, typically +15 to +45 °C (+59 to +113 °F); 2 to 6 bar (29 to 87 psi)
- Data according to calibration protocol ±5 °C (±9 °F) and ±2 bar (±29 psi)
- Accuracy based on accredited calibration rigs according to ISO 17025

Performance characteristic Promass A

o.r. = of reading; 1 g/cm<sup>3</sup> = 1 kg/l; T = medium temperature

### Maximum measured error

The following values refer to the pulse/frequency output.  
The additional measured error at the current output is typically ±5 µA.  
Design fundamentals →  112.

- Mass flow and volume flow (liquids): ±0.10% o.r.
- Mass flow (gases): ±0.50% o.r.
- Density (liquids)
  - Reference conditions: ±0.0005 g/cm<sup>3</sup>
  - Field density calibration: ±0.0005 g/cm<sup>3</sup>  
(valid after field density calibration under process conditions)
  - Standard density calibration: ±0.02 g/cm<sup>3</sup>  
(valid over the entire temperature range and density range →  132)
  - Special density calibration: ±0.002 g/cm<sup>3</sup>  
(optional, valid range: +5 to +80 °C (+41 to +176 °F) and 0.0 to 2.0 g/cm<sup>3</sup>)
- Temperature: ±0.5 °C ± 0.005 · T °C; ±1 °F ± 0.003 · (T - 32) °F

### Zero point stability

DN		Max. full scale value		Zero point stability	
[mm]	[inch]	[kg/h] or [l/h]	[lb/min]	[kg/h] or [l/h]	[lb/min]
1	1/24	20	0.73	0.0010	0.000036
2	1/12	100	3.70	0.0050	0.00018
4	1/8	450	16.5	0.0225	0.0008

### Example for max. measured error

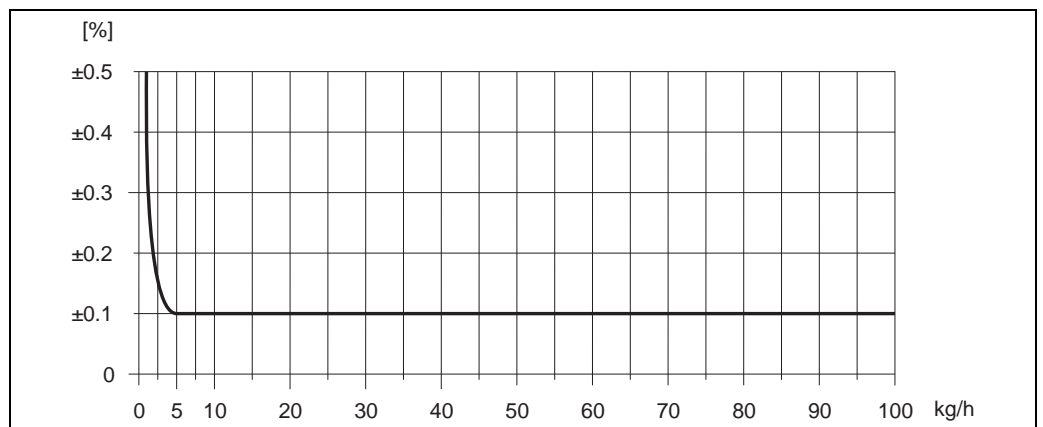

Fig. 50: Max. measured error in % o.r. (example: Promass A, DN 2)

a0003401

**Flow values (example)**

Turn down	Flow		Max. measured error [% o.r.]
	[kg/h]	[lb/min.]	
250:1	0.4	0.0147	1.250
100:1	1.0	0.0368	0.500
25:1	4.0	0.1470	0.125
10:1	10	0.3675	0.100
2:1	50	1.8375	0.100

Design fundamentals → 112

**Repeatability**

Design fundamentals → 112

- Mass flow and volume flow (liquids): ±0.05% o.r.
- Mass flow (gases): ±0.25% o.r.
- Density (liquids): ±0.00025 g/cm<sup>3</sup>
- Temperature: ±0.25 °C ± 0.0025 · T °C; ±0.5 °F ± 0.0015 · (T - 32) °F

**Influence of medium temperature**

When there is a difference between the temperature for zero point adjustment and the process temperature, the typical measured error of the sensor is ±0.0002% of the full scale value / °C (±0.0001% of the full scale value/°F).

**Influence of medium pressure**

A difference in pressure between the calibration pressure and the process pressure does not have any effect on the accuracy.

**Design fundamentals**

Dependent on the flow:

- Flow ≥ Zero point stability ÷ (Base accuracy ÷ 100)
  - Max. measured error: ±Base accuracy in % o.r.
  - Repeatability: ± ½ · Base accuracy in % o.r.
- Flow < Zero point stability ÷ (Base accuracy ÷ 100)
  - Max. measured error: ± (Zero point stability ÷ measured value) · 100% o.r.
  - Repeatability: ± ½ · (Zero point stability ÷ measured value) · 100% o.r.

Base accuracy for	
Mass flow liquids	0.10
Volume flow liquids	0.10
Mass flow gases	0.50



Performance characteristic Promass E o.r. = of reading;  $1 \text{ g/cm}^3 = 1 \text{ kg/l}$ ; T = medium temperature

**Maximum measured error**

The following values refer to the pulse/frequency output.  
 The additional measured error at the current output is typically  $\pm 5 \mu\text{A}$ .  
 Design fundamentals →  115.

- Mass flow and volume flow (liquids):  $\pm 0.25\%$  o.r.
- Mass flow (gases):  $\pm 0.75\%$  o.r.
- Density (liquids)
  - Reference conditions:  $\pm 0.0005 \text{ g/cm}^3$
  - Field density calibration:  $\pm 0.0005 \text{ g/cm}^3$   
 (valid after field density calibration under process conditions)
  - Standard density calibration:  $\pm 0.02 \text{ g/cm}^3$   
 (valid over the entire temperature range and density range →  132)
- Temperature:  $\pm 0.5 \text{ }^\circ\text{C} \pm 0.005 \cdot T \text{ }^\circ\text{C}$ ;  $\pm 1 \text{ }^\circ\text{F} \pm 0.003 \cdot (T - 32) \text{ }^\circ\text{F}$

**Zero point stability**

DN		Zero point stability	
[mm]	[inch]	[kg/h] or [l/h]	[lb/min]
8	3/8	0.20	0.0074
15	1/2	0.65	0.0239
25	1	1.80	0.0662
40	1 1/2	4.50	0.1654
50	2	7.00	0.2573
80	3	18.00	0.6615

**Example for max. measured error**

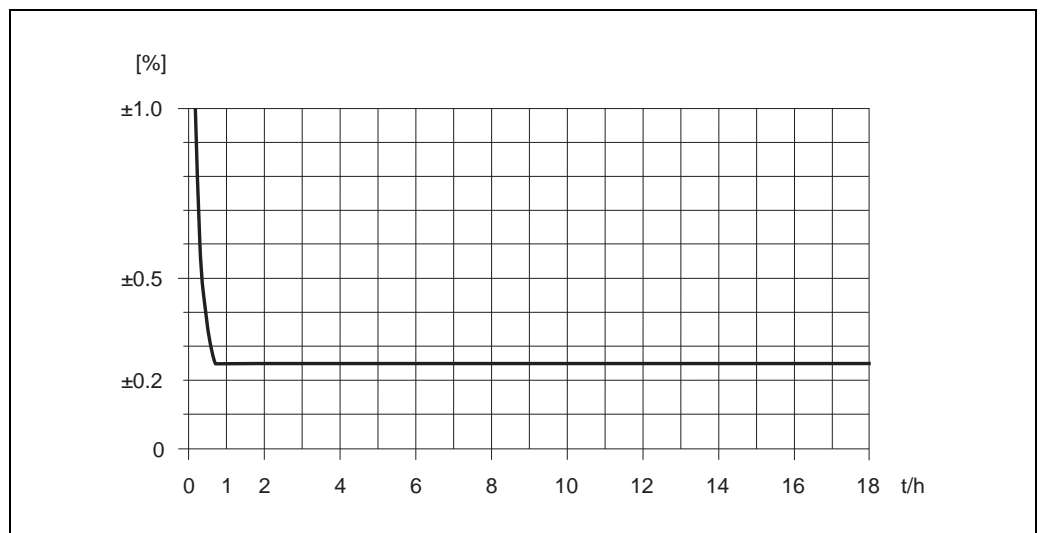

Fig. 51: Max. measured error in % o.r. (example: Promass E, DN 25)

**Flow values (example)**

Turn down	Flow		Maximum measured error [% o.r.]
	[kg/h]	[lb/min]	
250 : 1	72	2.646	2.50
100 : 1	180	6.615	1.00
25 : 1	720	26.46	0.25
10 : 1	1800	66.15	0.25
2 : 1	9000	330.75	0.25

Design fundamentals →  115

**Repeatability**

Design fundamentals →  115

- Mass flow and volume flow (liquids): ±0.10% o.r.
- Mass flow (gases): ±0.35% o.r.
- Density (liquids): ±0.00025 g/cm<sup>3</sup>
- Temperature: ±0.25 °C ± 0.0025 · T °C; ±0.5 °F ± 0.0015 · (T - 32) °F

**Influence of medium temperature**

When there is a difference between the temperature for zero point adjustment and the process temperature, the typical measured error of the sensor is ±0.0002% of the full scale value / °C (±0.0001% of the full scale value/°F).

**Influence of medium pressure**

The table below shows the effect on accuracy of mass flow due to a difference between calibration pressure and process pressure.

DN		[% o.r./bar]
[mm]	[inch]	
8	3/8	no influence
15	½	no influence
25	1	no influence
40	1½	no influence
50	2	-0.009
80	3	-0.020

### Design fundamentals

Dependent on the flow:

- Flow  $\geq$  Zero point stability  $\div$  (Base accuracy  $\div$  100)
  - Max. measured error:  $\pm$ Base accuracy in % o.r.
  - Repeatability:  $\pm \frac{1}{2}$  · Base accuracy in % o.r.
- Flow  $<$  Zero point stability  $\div$  (Base accuracy  $\div$  100)
  - Max. measured error:  $\pm$  (Zero point stability  $\div$  measured value) · 100% o.r.
  - Repeatability:  $\pm \frac{1}{2}$  · (Zero point stability  $\div$  measured value) · 100% o.r.

Base accuracy for	
Mass flow liquids	0.25
Volume flow liquids	0.25
Mass flow gases	0.75

Performance characteristic  
Promass F

o.r. = of reading;  $1 \text{ g/cm}^3 = 1 \text{ kg/l}$ ; T = medium temperature

### Maximum measured error

The following values refer to the pulse/frequency output.

The additional measured error at the current output is typically  $\pm 5 \mu\text{A}$ .

Design fundamentals  $\rightarrow$   117.

- Mass flow and volume flow (liquids):
  - $\pm 0.05\%$  o.r. (PremiumCal, for mass flow)
  - $\pm 0.10\%$  o.r.
- Mass flow (gases):  $\pm 0.35\%$  o.r.
- Density (liquids)
  - Reference conditions:  $\pm 0.0005 \text{ g/cm}^3$
  - Field density calibration:  $\pm 0.0005 \text{ g/cm}^3$   
(valid after field density calibration under process conditions)
  - Standard density calibration:  $\pm 0.01 \text{ g/cm}^3$   
(valid over the entire temperature range and density range  $\rightarrow$   132)
  - Special density calibration:  $\pm 0.001 \text{ g/cm}^3$   
(optional, valid range:  $+5$  to  $+80 \text{ }^\circ\text{C}$  ( $+41$  to  $+176 \text{ }^\circ\text{F}$ ) and  $0.0$  to  $2.0 \text{ g/cm}^3$ )
- Temperature:  $\pm 0.5 \text{ }^\circ\text{C} \pm 0.005 \cdot T \text{ }^\circ\text{C}$ ;  $\pm 1 \text{ }^\circ\text{F} \pm 0.003 \cdot (T - 32) \text{ }^\circ\text{F}$

### Zero point stability Promass F (standard)

DN		Zero point stability Promass F (Standard)	
[mm]	[inch]	[kg/h] or [l/h]	[lb/min]
8	3/8	0.030	0.001
15	1/2	0.200	0.007
25	1	0.540	0.019
40	1 1/2	2.25	0.083
50	2	3.50	0.129
80	3	9.00	0.330
100	4	14.00	0.514
150	6	32.00	1.17
250	10	88.00	3.23

Zero point stability Promass F (high-temperature version)

DN		Zero point stability Promass F (high-temperature version)	
[mm]	[inch]	[kg/h] or [l/h]	[lb/min]
25	1	1.80	0.0661
50	2	7.00	0.2572
80	3	18.0	0.6610

Example for max. measured error

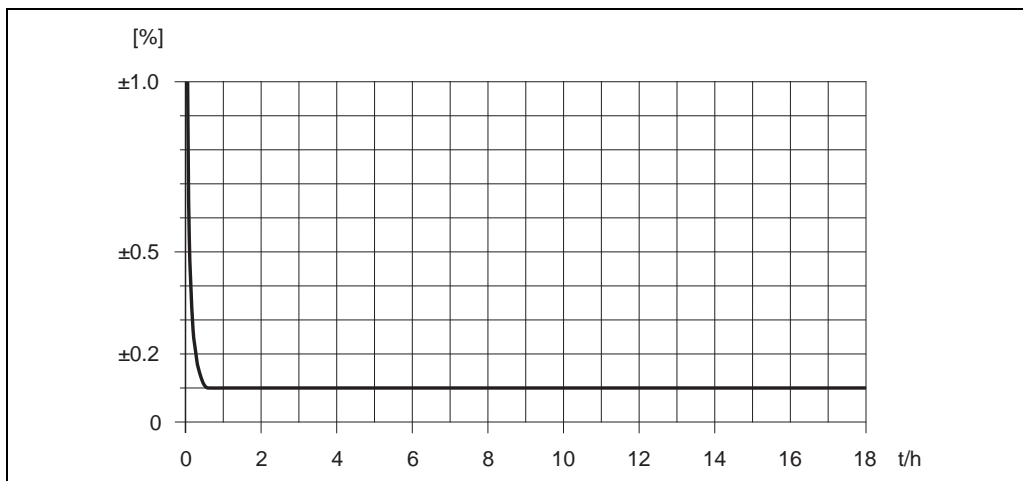

Fig. 52: Max. measured error in % o.r. (example: Promass F, DN 25)

Flow values (example)

Turn down	Flow		Maximum measured error [% o.r.]
	[kg/h]	[lb/min]	
500 : 1	36	1.323	1.5
100 : 1	180	6.615	0.3
25 : 1	720	26.46	0.1
10 : 1	1800	66.15	0.1
2 : 1	9000	330.75	0.1

Design fundamentals → 117

Repeatability

Design fundamentals → 117.

- Mass flow and volume flow (liquids):  
 ±0.025% o.r. (PremiumCal, for mass flow)  
 ±0.05% o.r.
- Mass flow (gases): ±0.25% o.r.
- Density (liquids): ±0.00025 g/cm<sup>3</sup>
- Temperature: ±0.25 °C ± 0.0025 · T °C; ±0.5 °F ± 0.0015 · (T - 32) °F

### Influence of medium temperature

When there is a difference between the temperature for zero point adjustment and the process temperature, the typical measured error of the sensor is  $\pm 0.0002\%$  of the full scale value / °C ( $\pm 0.0001\%$  of the full scale value/°F).

### Influence of medium pressure

The table below shows the effect on accuracy of mass flow due to a difference between calibration pressure and process pressure.

DN		Promass F (standard)	Promass F (high-temperature version)
[mm]	[inch]	[% o.r./bar]	[% o.r./bar]
8	3/8	no influence	-
15	1/2	no influence	-
25	1	no influence	no influence
40	1 1/2	-0.003	-
50	2	-0.008	-0.008
80	3	-0.009	-0.009
100	4	-0.007	-
150	6	-0.009	-
250	10	-0.009	-

### Design fundamentals

Dependent on the flow:

- Flow  $\geq$  Zero point stability  $\div$  (Base accuracy  $\div$  100)
  - Max. measured error:  $\pm$ Base accuracy in % o.r.
  - Repeatability:  $\pm 1/2 \cdot$  Base accuracy in % o.r.
- Flow  $<$  Zero point stability  $\div$  (Base accuracy  $\div$  100)
  - Max. measured error:  $\pm$  (Zero point stability  $\div$  measured value)  $\cdot$  100% o.r.
  - Repeatability:  $\pm 1/2 \cdot$  (Zero point stability  $\div$  measured value)  $\cdot$  100% o.r.

Base accuracy for	
Mass flow liquids, PremiumCal	0.05
Mass flow liquids	0.10
Volume flow liquids	0.10
Mass flow gases	0.35

Performance characteristic Promass H o.r. = of reading;  $1 \text{ g/cm}^3 = 1 \text{ kg/l}$ ; T = medium temperature

**Maximum measured error**

The following values refer to the pulse/frequency output.  
 The additional measured error at the current output is typically  $\pm 5 \mu\text{A}$ .  
 Design fundamentals → 120.

- Mass flow and volume flow (liquids)  
 Zirconium 702/R 60702 and Tantalum 2.5W:  $\pm 0.10\%$  o.r.
- Mass flow (gases)  
 Tantalum 2.5W:  $\pm 0.50\%$  o.r.
- Density (liquids)  
 Zirconium 702/R 60702 and Tantalum 2.5W
  - Reference conditions:  $\pm 0.0005 \text{ g/cm}^3$
  - Field density calibration:  $\pm 0.0005 \text{ g/cm}^3$   
 (valid after field density calibration under process conditions)
  - Standard density calibration:  $\pm 0.02 \text{ g/cm}^3$   
 (valid over the entire temperature range and density range → 132)
  - Special density calibration:  $\pm 0.002 \text{ g/cm}^3$   
 (optional, valid range:  $+10$  to  $+80 \text{ }^\circ\text{C}$  ( $+50$  to  $+176 \text{ }^\circ\text{F}$ ) and  $0.0$  to  $2.0 \text{ g/cm}^3$ )
- Temperature:  $\pm 0.5 \text{ }^\circ\text{C} \pm 0.005 \cdot T \text{ }^\circ\text{C}$ ;  $\pm 1 \text{ }^\circ\text{F} \pm 0.003 \cdot (T - 32) \text{ }^\circ\text{F}$

**Zero point stability**

DN		Zero point stability	
[mm]	[inch]	[kg/h] or [l/h]	[lb/min]
8	3/8	0.20	0.007
15	1/2	0.65	0.024
25	1	1.80	0.066
40	1 1/2	4.50	0.165
50	2	7.00	0.257

**Example for max. measured error**

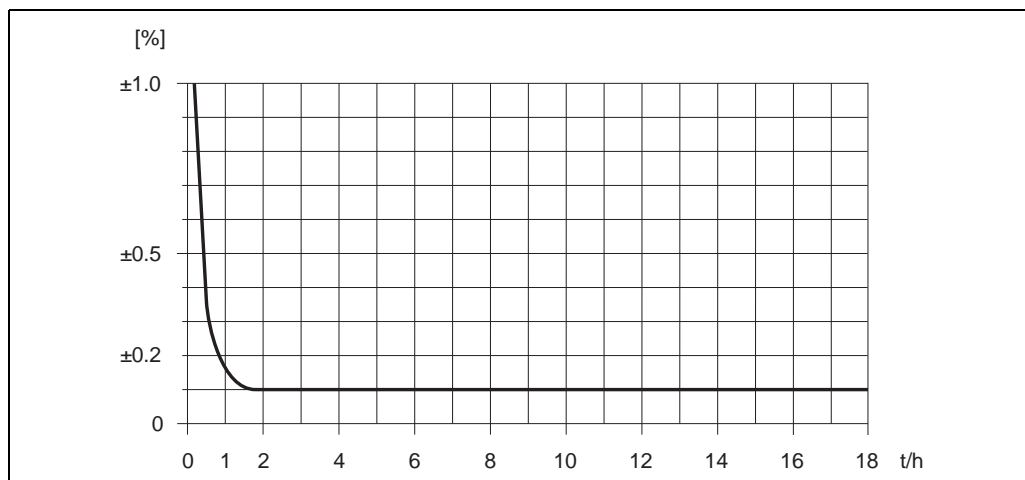

Fig. 53: Max. measured error in % o.r. (example: Promass H, DN 25)

*Flow values (example)*

Turn down	Flow		Maximum measured error [% o.r.]
	[kg/h]	[lb/min]	
250 : 1	72	2.646	2.50
100 : 1	180	6.615	1.00
25 : 1	720	26.46	0.25
10 : 1	1800	66.15	0.10
2 : 1	9000	330.75	0.10

Design fundamentals → 120

**Repeatability**

Design fundamentals → 120.

*Material measuring tube: Zirconium 702/R 60702*

- Mass flow and volume flow (liquids):  $\pm 0.05\%$  o.r.
- Density (liquids):  $\pm 0.00025$  g/cm<sup>3</sup>
- Temperature:  $\pm 0.25$  °C  $\pm 0.0025 \cdot T$  °C;  $\pm 0.5$  °F  $\pm 0.0015 \cdot (T - 32)$  °F

*Material measuring tube: Tantalum 2.5W*

- Mass flow and volume flow (liquids):  $\pm 0.05\%$  o.r.
- Mass flow (gases):  $\pm 0.25\%$  o.r.
- Density (liquids):  $\pm 0.0005$  g/cm<sup>3</sup>
- Temperature:  $\pm 0.25$  °C  $\pm 0.0025 \cdot T$  °C;  $\pm 0.5$  °F  $\pm 0.0015 \cdot (T - 32)$  °F

**Influence of medium temperature**

When there is a difference between the temperature for zero point adjustment and the process temperature, the typical measured error of the sensor is  $\pm 0.0002\%$  of the full scale value / °C ( $\pm 0.0001\%$  of the full scale value/°F).

**Influence of medium pressure**

The table below shows the effect on accuracy of mass flow due to a difference between calibration pressure and process pressure.

DN		Promass H Zirconium 702/R 60702	Promass H Tantalum 2.5W
[mm]	[inch]	[% o.r./bar]	[% o.r./bar]
8	3/8	-0.017	-0.010
15	1/2	-0.021	-0.005
25	1	-0.013	-0.015
40	1 1/2	-0.018	-0.012
50	2	-0.020	-0.016

**Design fundamentals**

Dependent on the flow:

- Flow ≥ Zero point stability ÷ (Base accuracy ÷ 100)
  - Max. measured error: ±Base accuracy in % o.r.
  - Repeatability: ± ½ · Base accuracy in % o.r.
- Flow < Zero point stability ÷ (Base accuracy ÷ 100)
  - Max. measured error: ± (Zero point stability ÷ measured value) · 100% o.r.
  - Repeatability: ± ½ · (Zero point stability ÷ measured value) · 100% o.r.

Base accuracy for	
Mass flow liquids	0.10
Volume flow liquids	0.10
Mass flow gases	0.50

Performance characteristic Promass I o.r. = of reading; 1 g/cm<sup>3</sup> = 1 kg/l; T = medium temperature

**Maximum measured error**

The following values refer to the pulse/frequency output.  
 The additional measured error at the current output is typically ±5 µA.  
 Design fundamentals → 122.

- Mass flow and volume flow (liquids): ±0.10% o.r.
- Mass flow (gases): ±0.50% o.r.
- Density (liquids)
  - Reference conditions: ±0.0005 g/cm<sup>3</sup>
  - Field density calibration: ±0.0005 g/cm<sup>3</sup>  
(valid after field density calibration under process conditions)
  - Standard density calibration: ±0.02 g/cm<sup>3</sup>  
(valid over the entire temperature range and density range → 132)
  - Special density calibration: ±0.004 g/cm<sup>3</sup>  
(optional, valid range: +10 to +80 °C (+50 to +176 °F) and 0.0 to 2.0 g/cm<sup>3</sup>)
- Temperature: ±0.5 °C ± 0.005 · T °C; ±1 °F ± 0.003 · (T - 32) °F

**Zero point stability**

DN		Zero point stability	
[mm]	[inch]	[kg/h] or [l/h]	[lb/min]
8	3/8	0.150	0.0055
15	½	0.488	0.0179
15 FB	½ FB	1.350	0.0496
25	1	1.350	0.0496
25 FB	1 FB	3.375	0.124
40	1½	3.375	0.124
40 FB	1½ FB	5.250	0.193
50	2	5.250	0.193
50 FB	2 FB	13.50	0.496
80	3	13.50	0.496

FB = Full bore



**Example for max. measured error**

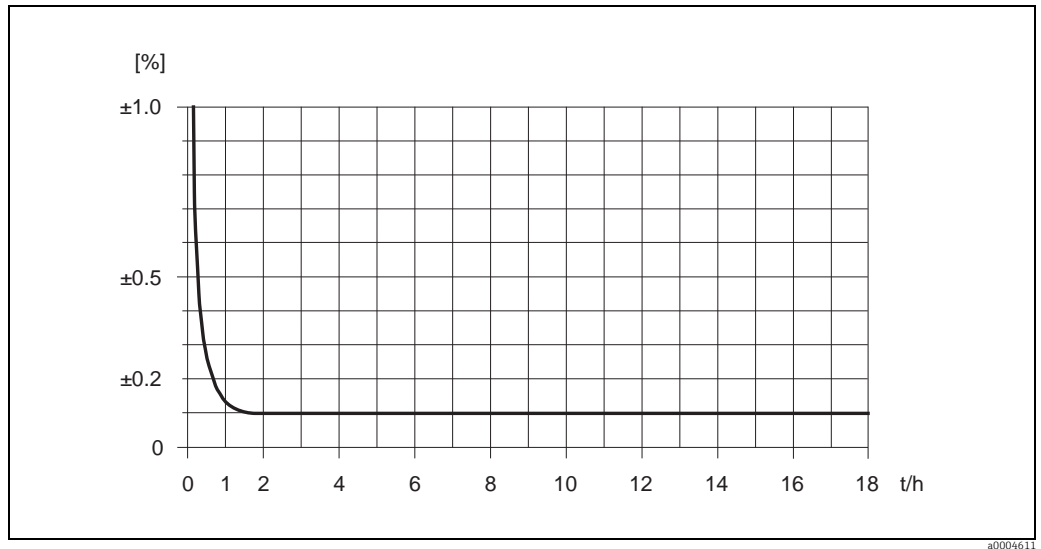

Fig. 54: Max. measured error in % o.r. (example: Promass I, DN 25)

*Flow values (example)*

Turn down	Flow		Maximum measured error [% o.r.]
	[kg/h]	[lb/min]	
250 : 1	72	2.646	1.875
100 : 1	180	6.615	0.750
25 : 1	720	26.46	0.188
10 : 1	1800	66.15	0.100
2 : 1	9000	330.75	0.100

Design fundamentals → 122

**Repeatability**

Design fundamentals → 122

- Mass flow and volume flow (liquids): ±0.05% o.r.
- Mass flow (gases): ±0.25% o.r.
- Density (liquids): ±0.00025 g/cm<sup>3</sup>
- Temperature: ±0.25 °C ± 0.0025 · T °C; ±0.5 °F ± 0.0015 · (T - 32) °F

**Influence of medium temperature**

When there is a difference between the temperature for zero point adjustment and the process temperature, the typical measured error of the sensor is ±0.0002% of the full scale value / °C (±0.0001% of the full scale value/°F).

**Influence of medium pressure**

The table below shows the effect on accuracy of mass flow due to a difference between calibration pressure and process pressure.

DN		[% o.r./bar]
[mm]	[inch]	
8	3/8	0.006
15	1/2	0.004
15 FB	1/2 FB	0.006
25	1	0.006
25 FB	1 FB	no influence
40	1 1/2	no influence
40 FB	1 1/2 FB	-0.003
50	2	-0.003
50 FB	2 FB	0.003
80	3	no influence

FB = Full bore

**Design fundamentals**

Dependent on the flow:

- Flow ≥ Zero point stability ÷ (Base accuracy ÷ 100)
  - Max. measured error: ±Base accuracy in % o.r.
  - Repeatability: ± 1/2 · Base accuracy in % o.r.
- Flow < Zero point stability ÷ (Base accuracy ÷ 100)
  - Max. measured error: ± (Zero point stability ÷ measured value) · 100% o.r.
  - Repeatability: ± 1/2 · (Zero point stability ÷ measured value) · 100% o.r.

Base accuracy for	
Mass flow liquids	0.10
Volume flow liquids	0.10
Mass flow gases	0.50

Performance characteristic Promass O o.r. = of reading; 1 g/cm<sup>3</sup> = 1 kg/l; T = medium temperature

**Maximum measured error**

The following values refer to the pulse/frequency output.  
 The additional measured error at the current output is typically ±5 µA.  
 Design fundamentals →  124.

- Mass flow and volume flow (liquids):
  - ±0.05% o.r. (PremiumCal, for mass flow)
  - ±0.10% o.r.
- Mass flow (gases): ±0.35% o.r.
- Density (liquids)
  - Reference conditions: ±0.0005 g/cm<sup>3</sup>
  - Field density calibration: ±0.0005 g/cm<sup>3</sup>  
(valid after field density calibration under process conditions)
  - Standard density calibration: ±0.01 g/cm<sup>3</sup>  
(valid over the entire temperature range and density range →  132)
  - Special density calibration: ±0.001 g/cm<sup>3</sup>  
(optional, valid range: +5 to +80 °C (+41 to +176 °F) and 0.0 to 2.0 g/cm<sup>3</sup>)
- Temperature: ±0.5 °C ± 0.005 · T °C; ±1 °F ± 0.003 · (T - 32) °F

### Zero point stability

DN		Zero point stability Promass F (Standard)	
[mm]	[inch]	[kg/h] or [l/h]	[lb/min]
80	3	9.00	0.330
100	4	14.00	0.514
150	6	32.00	1.17

### Example for max. measured error

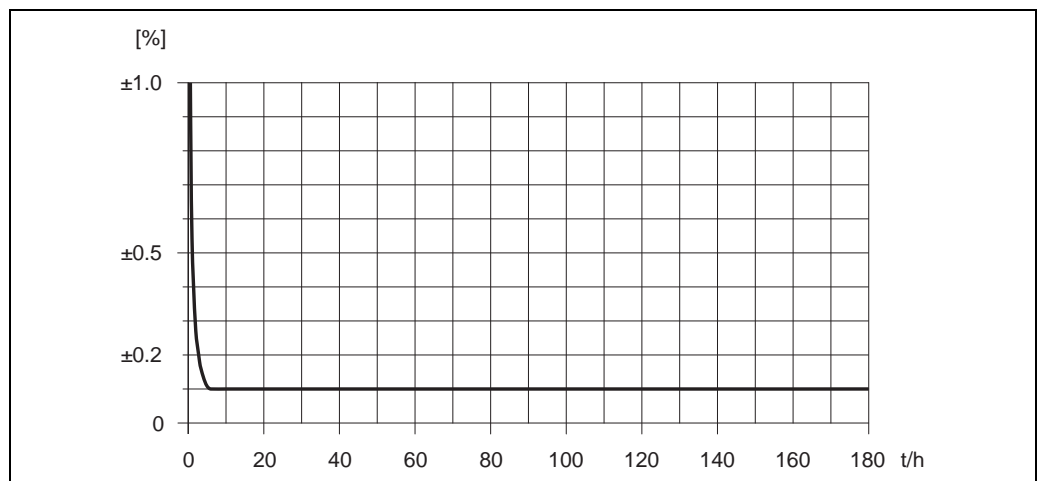

Fig. 55: Max. measured error in % o.r. (example DN 80)

### Flow values (example DN 80)

Turn down	Flow		Maximum measured error [% o.r.]
	[kg/h]	[lb/min]	
500 : 1	360	13.23	1.5
100 : 1	1800	66.15	0.3
25 : 1	7200	264.6	0.1
10 : 1	18000	661.5	0.1
2 : 1	90000	3307.5	0.1

Design fundamentals → 124

### Repeatability

Design fundamentals → 124.

- Mass flow and volume flow (liquids):  
 $\pm 0.025\%$  o.r. (PremiumCal, for mass flow)  
 $\pm 0.05\%$  o.r.
- Mass flow (gases):  $\pm 0.25\%$  o.r.
- Density (liquids):  $\pm 0.00025 \text{ g/cm}^3$
- Temperature:  $\pm 0.25 \text{ }^\circ\text{C} \pm 0.0025 \cdot T \text{ }^\circ\text{C}$ ;  $\pm 0.5 \text{ }^\circ\text{F} \pm 0.0015 \cdot (T - 32) \text{ }^\circ\text{F}$

**Influence of medium temperature**

When there is a difference between the temperature for zero point adjustment and the process temperature, the typical measured error of the sensor is  $\pm 0.0002\%$  of the full scale value / °C ( $\pm 0.0001\%$  of the full scale value/°F).

**Influence of medium pressure**

The table below shows the effect on accuracy of mass flow due to a difference between calibration pressure and process pressure.

DN		Promass F (standard)
[mm]	[inch]	[% o.r./bar]
80	3	-0.0055
100	4	-0.0035
150	6	-0.002

**Design fundamentals**

Dependent on the flow:

- Flow  $\geq$  Zero point stability  $\div$  (Base accuracy  $\div$  100)
  - Max. measured error:  $\pm$ Base accuracy in % o.r.
  - Repeatability:  $\pm \frac{1}{2}$  · Base accuracy in % o.r.
- Flow  $<$  Zero point stability  $\div$  (Base accuracy  $\div$  100)
  - Max. measured error:  $\pm$  (Zero point stability  $\div$  measured value) · 100% o.r.
  - Repeatability:  $\pm \frac{1}{2}$  · (Zero point stability  $\div$  measured value) · 100% o.r.

Base accuracy for	
Mass flow liquids, PremiumCal	0.05
Mass flow liquids	0.10
Volume flow liquids	0.10
Mass flow gases	0.35

Performance characteristic Promass P o.r. = of reading;  $1 \text{ g/cm}^3 = 1 \text{ kg/l}$ ; T = medium temperature

**Maximum measured error**

The following values refer to the pulse/frequency output.  
 The additional measured error at the current output is typically  $\pm 5 \mu\text{A}$ .  
 Design fundamentals → 126.

- Mass flow and volume flow (liquids):  $\pm 0.10\%$  o.r.
- Mass flow (gases):  $\pm 0.50\%$  o.r.
- Density (liquids)
  - Reference conditions:  $\pm 0.0005 \text{ g/cm}^3$
  - Field density calibration:  $\pm 0.0005 \text{ g/cm}^3$   
(valid after field density calibration under process conditions)
  - Standard density calibration:  $\pm 0.01 \text{ g/cm}^3$   
(valid over the entire temperature range and density range → 132)
  - Special density calibration:  $\pm 0.002 \text{ g/cm}^3$   
(optional, valid range:  $+5$  to  $+80 \text{ }^\circ\text{C}$  ( $+41$  to  $+176 \text{ }^\circ\text{F}$ ) and  $0.0$  to  $2.0 \text{ g/cm}^3$ )
- Temperature:  $\pm 0.5 \text{ }^\circ\text{C} \pm 0.005 \cdot T \text{ }^\circ\text{C}$ ;  $\pm 1 \text{ }^\circ\text{F} \pm 0.003 \cdot (T - 32) \text{ }^\circ\text{F}$

**Zero point stability**

DN		Zero point stability	
[mm]	[inch]	[kg/h] or [l/h]	[lb/min]
8	3/8	0.20	0.007
15	1/2	0.65	0.024
25	1	1.80	0.066
40	1 1/2	4.50	0.165
50	2	7.00	0.257

**Example for max. measured error**

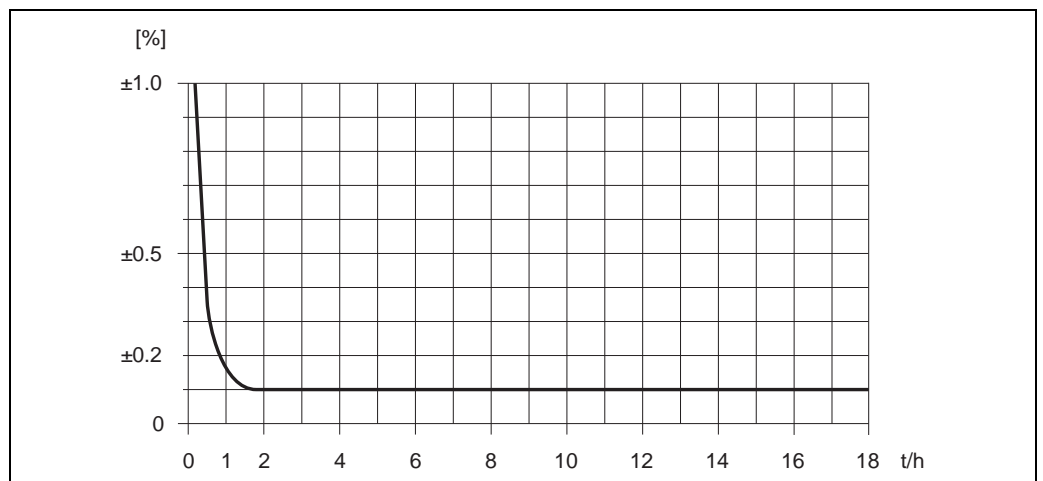

Fig. 56: Max. measured error in % o.r. (example: Promass P, DN 25)

**Flow values (example)**

Turn down	Flow		Maximum measured error [% o.r.]
	[kg/h]	[lb/min]	
250 : 1	72	2.646	2.50
100 : 1	180	6.615	1.00
25 : 1	720	26.46	0.25
10 : 1	1800	66.15	0.10
2 : 1	9000	330.75	0.10

Design fundamentals → 126

**Repeatability**

Design fundamentals → 126.

- Mass flow and volume flow (liquids): ±0.05% o.r.
- Mass flow (gases): ±0.25% o.r.
- Density (liquids): ±0.00025 g/cm<sup>3</sup>
- Temperature: ±0.25 °C ± 0.0025 · T °C; ±0.5 °F ± 0.0015 · (T - 32) °F

**Influence of medium temperature**

When there is a difference between the temperature for zero point adjustment and the process temperature, the typical measured error of the sensor is ±0.0002% of the full scale value / °C (±0.0001% of the full scale value/°F).

**Influence of medium pressure**

The table below shows the effect on accuracy of mass flow due to a difference between calibration pressure and process pressure.

DN		[% o.r./bar]
[mm]	[inch]	
8	3/8	-0.002
15	½	-0.006
25	1	-0.005
40	1½	-0.005
50	2	-0.005

**Design fundamentals**

Dependent on the flow:

- Flow ≥ Zero point stability ÷ (Base accuracy ÷ 100)
  - Max. measured error: ±Base accuracy in % o.r.
  - Repeatability: ± ½ · Base accuracy in % o.r.
- Flow < Zero point stability ÷ (Base accuracy ÷ 100)
  - Max. measured error: ± (Zero point stability ÷ measured value) · 100% o.r.
  - Repeatability: ± ½ · (Zero point stability ÷ measured value) · 100% o.r.

Base accuracy for	
Mass flow liquids	0.10
Volume flow liquids	0.10
Mass flow gases	0.50

Performance characteristic Promass S o.r. = of reading;  $1 \text{ g/cm}^3 = 1 \text{ kg/l}$ ; T = medium temperature

**Maximum measured error**

The following values refer to the pulse/frequency output.  
 The additional measured error at the current output is typically  $\pm 5 \mu\text{A}$ .  
 Design fundamentals  $\rightarrow$  128.

- Mass flow and volume flow (liquids):  $\pm 0.10\%$  o.r.
- Mass flow (gases):  $\pm 0.50\%$  o.r.
- Density (liquids)
  - Reference conditions:  $\pm 0.0005 \text{ g/cm}^3$
  - Field density calibration:  $\pm 0.0005 \text{ g/cm}^3$   
(valid after field density calibration under process conditions)
  - Standard density calibration:  $\pm 0.01 \text{ g/cm}^3$   
(valid over the entire temperature range and density range  $\rightarrow$  132)
  - Special density calibration:  $\pm 0.002 \text{ g/cm}^3$   
(optional, valid range:  $+5$  to  $+80 \text{ }^\circ\text{C}$  ( $+41$  to  $+176 \text{ }^\circ\text{F}$ ) and  $0.0$  to  $2.0 \text{ g/cm}^3$ )
- Temperature:  $\pm 0.5 \text{ }^\circ\text{C} \pm 0.005 \cdot T \text{ }^\circ\text{C}$ ;  $\pm 1 \text{ }^\circ\text{F} \pm 0.003 \cdot (T - 32) \text{ }^\circ\text{F}$

**Zero point stability**

DN		Zero point stability	
[mm]	[inch]	[kg/h] or [l/h]	[lb/min]
8	3/8	0.20	0.007
15	1/2	0.65	0.024
25	1	1.80	0.066
40	1 1/2	4.50	0.165
50	2	7.00	0.257

**Example for max. measured error**

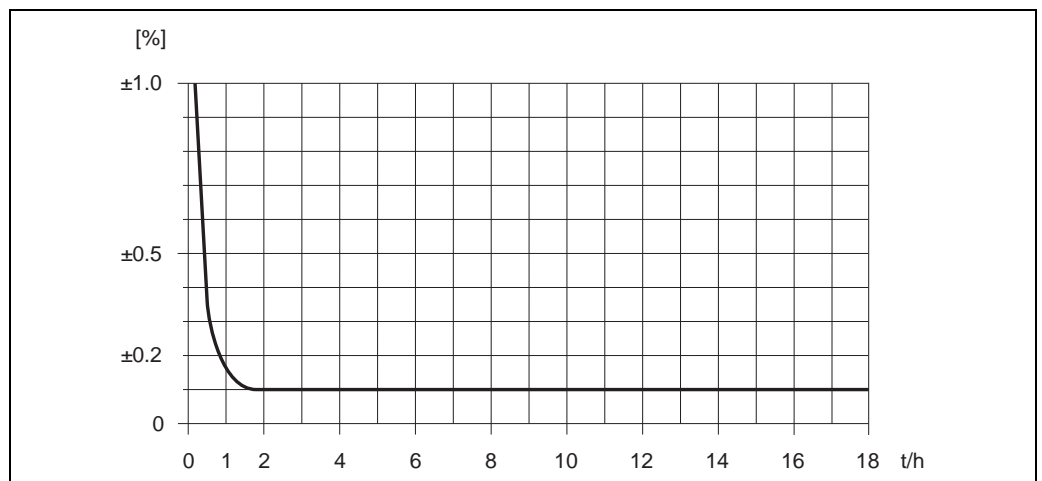

Fig. 57: Max. measured error in % o.r. (example: Promass S, DN 25)

**Flow values (example)**

Turn down	Flow		Maximum measured error [% o.r.]
	[kg/h]	[lb/min]	
250 : 1	72	2.646	2.50
100 : 1	180	6.615	1.00
25 : 1	720	26.46	0.25
10 : 1	1800	66.15	0.10
2 : 1	9000	330.75	0.10

Design fundamentals → 128

**Repeatability**

Design fundamentals → 128.

- Mass flow and volume flow (liquids): ±0.05% o.r.
- Mass flow (gases): ±0.25% o.r.
- Density (liquids): ±0.00025 g/cm<sup>3</sup>
- Temperature: ±0.25 °C ± 0.0025 · T °C; ±0.5 °F ± 0.0015 · (T - 32) °F

**Influence of medium temperature**

When there is a difference between the temperature for zero point adjustment and the process temperature, the typical measured error of the sensor is ±0.0002% of the full scale value / °C (±0.0001% of the full scale value/°F).

**Influence of medium pressure**

The table below shows the effect on accuracy of mass flow due to a difference between calibration pressure and process pressure.

DN		[% o.r./bar]
[mm]	[inch]	
8	3/8	-0.002
15	½	-0.006
25	1	-0.005
40	1½	-0.005
50	2	-0.005

**Design fundamentals**

Dependent on the flow:

- Flow ≥ Zero point stability ÷ (Base accuracy ÷ 100)
  - Max. measured error: ±Base accuracy in % o.r.
  - Repeatability: ± ½ · Base accuracy in % o.r.
- Flow < Zero point stability ÷ (Base accuracy ÷ 100)
  - Max. measured error: ± (Zero point stability ÷ measured value) · 100% o.r.
  - Repeatability: ± ½ · (Zero point stability ÷ measured value) · 100% o.r.

Base accuracy for	
Mass flow liquids	0.10
Volume flow liquids	0.10
Mass flow gases	0.50



Performance characteristic Promass X o.r. = of reading;  $1 \text{ g/cm}^3 = 1 \text{ kg/l}$ ; T = medium temperature

**Maximum measured error**

The following values refer to the pulse/frequency output.  
 The additional measured error at the current output is typically  $\pm 5 \mu\text{A}$ .  
 Design fundamentals → 130.

- Mass flow and volume flow (liquids):  
 $\pm 0.05\%$  o.r. (PremiumCal, for mass flow)  
 $\pm 0.10\%$  o.r.
- Mass flow (gases):  
 $\pm 0.35\%$  o.r.
- Density (liquids)
  - Reference conditions:  $\pm 0.0005 \text{ g/cm}^3$
  - Field density calibration:  $\pm 0.0005 \text{ g/cm}^3$   
 (valid after field density calibration under process conditions)
  - Standard density calibration:  $\pm 0.01 \text{ g/cm}^3$   
 (valid over the entire temperature range and density range → 132)
  - Special density calibration:  $\pm 0.001 \text{ g/cm}^3$   
 (optional, valid range:  $+5$  to  $+80 \text{ }^\circ\text{C}$  ( $+41$  to  $+176 \text{ }^\circ\text{F}$ ) and  $0.0$  to  $2.0 \text{ g/cm}^3$ )
- Temperature:  $\pm 0.5 \text{ }^\circ\text{C} \pm 0.005 \cdot T \text{ }^\circ\text{C}$ ;  $\pm 1 \text{ }^\circ\text{F} \pm 0.003 \cdot (T - 32) \text{ }^\circ\text{F}$

**Zero point stability**

DN		Zero point stability Promass F (Standard)	
[mm]	[inch]	[kg/h] or [l/h]	[lb/min]
350	14	137	5.03

**Example for max. measured error**

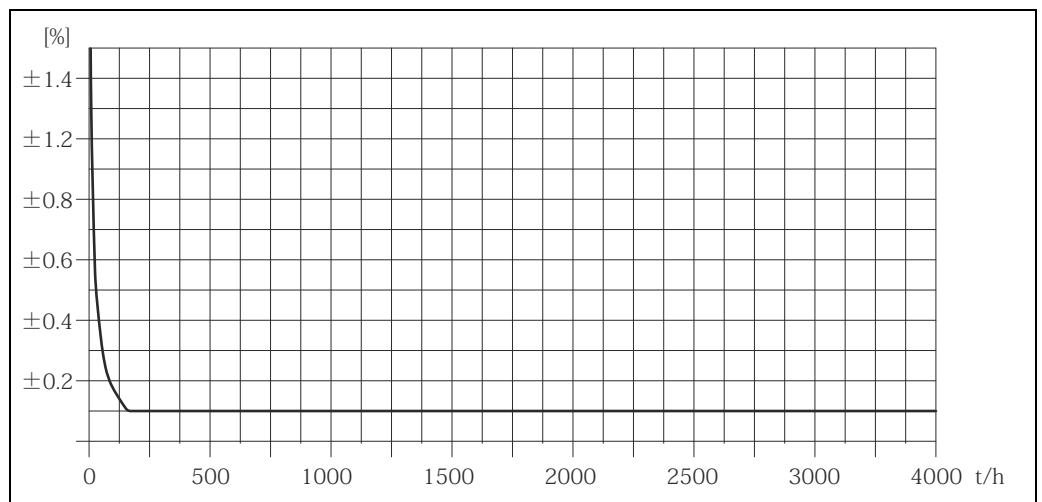

Fig. 58: Max. measured error in % o.r. (example: Promass 83X, DN 350)

**Flow values (example DN 350 (14"))**

Turn down	Flow	
	[kg/h]	[lb/min]
1 : 500	8200	301.4
1 : 100	41000	1507
1 : 50	82 000	3014
1 : 20	205 000	7535
1 : 10	410 000	15070
1 : 1	4 100 000	150700

Design fundamentals → 130

**Repeatability**

Design fundamentals → 130.

- Mass flow and volume flow (liquids):  
±0.025% o.r. (PremiumCal, for mass flow)  
±0.05% o.r.
- Mass flow (gases):  
±0,25% o.r.
- Density (liquids): ±0.00025 g/cm<sup>3</sup>
- Temperature: ±0.25 °C ± 0.0025 · T °C; ±0.5 °F ± 0.0015 · (T - 32) °F

**Influence of medium temperature**

When there is a difference between the temperature for zero point adjustment and the process temperature, the typical measured error of the sensor is ±0.0002% of the full scale value / °C (±0.0001% of the full scale value/°F).

**Influence of medium pressure**

The table below shows the effect on accuracy of mass flow due to a difference between calibration pressure and process pressure.

DN		Promass F (standard)
[mm]	[inch]	[% o.r./bar]
350	14	-0.009



**Design fundamentals**

Dependent on the flow:

- Flow ≥ Zero point stability ÷ (Base accuracy ÷ 100)
  - Max. measured error: ±Base accuracy in % o.r.
  - Repeatability: ± ½ · Base accuracy in % o.r.
- Flow < Zero point stability ÷ (Base accuracy ÷ 100)
  - Max. measured error: ± (Zero point stability ÷ measured value) · 100% o.r.
  - Repeatability: ± ½ · (Zero point stability ÷ measured value) · 100% o.r.

Base accuracy for	
Mass flow liquids, PremiumCal	0.05
Mass flow liquids	0.10
Volume flow liquids	0.10
Mass flow gases	0.35

## 10.7 Installation

Installation instructions	→  13
Inlet and outlet runs	There are no installation requirements regarding inlet and outlet runs.
Length of connecting cable remote version	max. 20 m (65 ft)
System pressure	→  14

## 10.8 Environment

Ambient temperature range	<p>Sensor and transmitter:</p> <ul style="list-style-type: none"> <li>■ Standard: -20 to +60 °C (-4 to +140°F)</li> <li>■ Optional: -40 to +60 °C (-40 to +140°F)</li> </ul> <p> Note!</p> <ul style="list-style-type: none"> <li>■ Install the device at a shady location. Avoid direct sunlight, particularly in warm climatic regions.</li> <li>■ At ambient temperatures below -20 °C (-4 °F) the readability of the display may be impaired.</li> </ul>
Storage temperature	-40 to +80 °C (-40 to +175 °F), preferably +20 °C (+68 °F)
Degree of protection	Standard: IP 67 (NEMA 4X) for transmitter and sensor
Shock resistance	According to IEC 60068-2-31
Vibration resistance	Acceleration up to 1 g, 10 to 150 Hz, following IEC 60068-2-6
CIP cleaning	Yes
SIP cleaning	Yes
Electromagnetic compatibility (EMC)	To IEC/EN 61326 and NAMUR Recommendation NE 21

## 10.9 Process

Medium temperature range **Sensor:**

*Promass F, A, P:*

-50 to +200 °C (-58 to +392 °F)

*Promass F (high-temperature version):*

-50 to +350 °C (-58 to +662 °F)

*Promass H:*

- Zirconium 702/R 60702: -50 to +200 °C (-58 to +392 °F)
- Tantalum 2.5W: -50 to +150 °C (-58 to +302 °F)

*Promass I, S:*

-50 to +150 °C (-58 to +302 °F)

*Promass E:*

-40 to +140 °C (-40 to +284 °F)

*Promass O*

-40 to +200 °C (-40 to +392 °F)

*Promass X*

-50 to +180 °C (-40 to +356 °F)

**Seals:**

*Promass F, E, H, I, S, P, O, X:*

No internal seals

*Promass A*

No seals inlying.

Only for mounting sets with threaded connections:

Viton: -15 to +200 °C (-5 to +392 °F)

EPDM: -40 to +160 °C (-40 to +320 °F)

Silicon: -60 to +200 °C (-76 to +392 °F)

Kalrez: -20 to +275 °C (-4 to +527 °F);

Fluid density range 0 to 5000 kg/m<sup>3</sup> (0 to 312 lb/cf)

Secondary containment pressure rating

The material load diagrams (pressure-temperature diagrams) for the process connections are provided in the separate "Technical Information" document on the device in question. This can be downloaded as a PDF file from [www.endress.com](http://www.endress.com). A list of the "Technical Information" documents available is provided in the "Documentation" section →  143.

**Pressure ranges of secondary containment:**

*Promass A:*

25 bar (362) psi

*Promass E:*

No secondary containment pressure rating

*Promass F:*

DN 8 to 50 (3/8 to 2"): 40 bar (580 psi)

DN 80 (3"): 25 bar (362 psi)

DN 100 to 150 (4 to 6"): 16 bar (232 psi)

DN 250(10"): 10 bar (145 psi)

*Promass H:*



Note!

Only one pressure rating for Promass H, use values for Tantalum version:

- DN 8 to 25 (3/8 to 1"): 25 bar (362 psi)
- DN 40 to 50 (1½ to 2"): 16 bar (232 psi)

*Promass I:*

40 bar (580 psi)

*Promass P:*

DN 8 to 25 (3/8 to 1"): 25 bar (362 psi)

DN 40 (1½"): 16 bar (232 psi)

DN 50 (2"): 10 bar (145 psi)

*Promass S:*

DN 8 to 25 (3/8 to 1"): 25 bar (362 psi)

DN 40 (1½"): 16 bar (232 psi)

DN 50 (2"): 10 bar (145 psi)

*Promass O:*

16 bar (232 psi)

*Promass X:*

Type approved, maximum allowable pressure according to ASME BPVC: 6 bar (87 psi)

Pressure-temperature ratings

The material load diagrams (pressure-temperature diagrams) for the process connections are provided in the separate "Technical Information" document on the device in question. This can be downloaded as a PDF file from [www.endress.com](http://www.endress.com). A list of the "Technical Information" documents available is provided in the "Documentation" section →  143.

Rupture disk

To increase the level of safety, a device version with a rupture disk with a triggering pressure of 10 to 15 bar (145 to 217.5 psi) (Promass X: 5,5 to 6,5 bar (80 to 94 psi)) can be used.

---

Special mounting instructions →  19.

---

Limiting flow

See the "Measuring range" section →  106.

Select nominal diameter by optimizing between required flow range and permissible pressure loss. See the "Measuring range" section for a list of max. possible full scale values.

- The minimum recommended full scale value is approx. 1/20 of the max. full scale value.
- In most applications, 20 to 50% of the maximum full scale value can be considered ideal.
- Select a lower full scale value for abrasive substances such as liquids with entrained solids (flow velocity < 1 m/s (3 ft/s)).
- For gas measurement the following rules apply:
  - Flow velocity in the measuring tubes should not be more than half the sonic velocity (0.5 Mach).
  - The maximum mass flow depends on the density of the gas: formula →  108

---

Pressure loss

To calculate the pressure loss, use the *Applicator* sizing tool (→  85).

## 10.10 Mechanical construction

**Design / dimensions** The dimensions and lengths of the sensor and transmitter are provided in the separate "Technical Information" document on the device in question. This can be downloaded as a PDF file from [www.endress.com](http://www.endress.com). A list of the "Technical Information" documents available is provided in the "Documentation" section →  143.

**Weight**

- Compact version: see table below
- Remote version
  - Sensor: see table below
  - Wall-mount housing: 5 kg (11 lb)

**Weight (SI units)** All values (weight) refer to devices with flanges according to EN/DIN PN 40. Weight data in [lb].

Promass F / DN	8	15	25	40	50	80	100	150	250*
Compact version	11	12	14	19	30	55	96	154	400
Compact version, high-temperature	-	-	14.7	-	30.7	55.7	-	-	-
Remote version	9	10	12	17	28	53	94	152	398
Remote version, high-temperature	-	-	13.5	-	29.5	54.5	-	-	-

\* With 10" according to ASME B16.5 Cl 300 flanges

Promass E / DN	8	15	25	40	50	80
Compact version	8	8	10	15	22	31
Remote version	6	6	8	13	20	29

Promass A / DN	1	2	4
Compact version	10	11	15
Remote version	8	9	13

Promass H / DN	8	15	25	40	50
Compact version	12	13	19	36	69
Remote version	10	11	17	34	67

Promass I / DN	8	15	15FB	25	25FB	40	40FB	50	50FB	80
Compact version	13	15	21	22	41	42	67	69	120	124
Remote version	11	13	19	20	38	40	65	67	118	122

"FB" = Full bore versions of Promass I

Promass S / DN	8	15	25	40	50
Compact version	13	15	21	43	80
Remote version	11	13	19	41	78

Promass P / DN	8	15	25	40	50
Compact version	13	15	21	43	80
Remote version	11	13	19	41	78

Promass O / DN <sup>1)</sup>	80	100	150
Compact version	75	141	246
Remote version	73	139	244

<sup>1)</sup> with Cl 900 flanges according to ASME

Promass X / DN 1)	350
Compact version	555
Remote version	553

<sup>1)</sup> with 12" according to ASME B16.5 Cl 150 flanges

Weight (US units)

All values (weight) refer to devices with EN/DIN PN 40 flanges.  
Weight data in [lb].

Promass F / DN	3/8"	1/2"	1"	1 ½"	2"	3"	4"	6"	10**
Compact version	24	26	31	42	66	121	212	340	882
Compact version, high-temperature	-	-	32	-	68	123	-	-	-
Remote version	20	22	26	37	62	117	207	335	878
Remote version, high-temperature	-	-	30	-	65	120	-	-	-

\* With 10" according to ASME B16.5 Cl 300 flanges

Promass E / DN	3/8"	1/2"	1	1 ½"	2"	3"
Compact version	18	18	22	33	49	69
Remote version	13	13	18	29	44	64

Promass A / DN	1/24"	1/12"	1/8"
Compact version	22	24	33
Remote version	18	20	29

Promass H / DN	3/8"	1/2"	1	1 ½"	2"
Compact version	26	29	42	79	152
Remote version	22	24	37	75	148

Promass I / DN	3/8"	1/2"	1/2"FB	1 ½"	1 ½"FB	3/8"	3/8"FB	1	1FB	2"
Compact version	29	33	46	49	90	93	148	152	265	273
Remote version	24	29	42	44	86	88	143	148	260	269

"FB" = Full bore versions of Promass I



Promass S / DN	3/8"	1/2"	1	1 1/2"	2"
Compact version	29	33	46	95	176
Remote version	24	29	42	90	172

Promass P / DN	3/8"	1/2"	1	1 1/2"	2"
Compact version	29	33	46	95	176
Remote version	24	29	42	90	172

Promass O / DN <sup>1)</sup>	3"	4"	6"
Compact version	165	311	542
Remote version	161	306	538

<sup>1)</sup> with Cl 900 flanges according to ASME

Promass X / DN <sup>1)</sup>	350
Compact version	1224
Remote version	1219

<sup>1)</sup> with 12" according to ASME B16.5 Cl 150 flanges

## Material

### Transmitter housing:

- Compact version
  - Compact version: powder coated die-cast aluminum
  - Stainless steel housing (II2G/Zone 1): stainless steel 1.4404/CF3M
  - Stainless steel housing: stainless steel 1.4301/ASTM 304
  - Window material: glass or polycarbonate
- Remote version
  - Remote field housing: powder coated die-cast aluminum
  - Wall-mount housing: powder coated die-cast aluminum
  - Window material: glass

### Sensor housing / containment:

#### Promass F:

- Acid- and alkali-resistant outer surface
- Stainless steel 1.4301/1.4307/304L

#### Promass E, A, H, I, S, P:

- Acid- and alkali-resistant outer surface
- Stainless steel 1.4301/304

#### Promass X, O:

- Acid- and alkali-resistant outer surface
- Stainless steel 1.4404/316L

### Connection housing, sensor (remote version):

- Stainless steel 1.4301/304 (standard, not Promass X)
- Powder coated die-cast aluminum  
(high-temperature version and version for heating)

**Process connections:***Promass F:*

- Flanges according to EN 1092-1 (DIN 2501) / according to ASME B16.5 / JIS B2220  
→ stainless steel 1.4404/316L
- Flanges according to EN 1092-1 (DIN 2501) / according to ASME B16.5 / JIS B2220  
→ Alloy C-22 2.4602/N 06022
- DIN 11864-2 Form A (flat flange with groove) → stainless steel 1.4404/316L
- Threaded hygienic connections DIN 11851/ DIN 11864-1, Form A / ISO 2853 / SMS 1145  
→ stainless steel 1.4404/316L
- Tri-Clamp (OD-tubes) → stainless steel 1.4404/316L
- VCO connection → stainless steel 1.4404/316L

*Promass F (high-temperature version):*

- Flanges according to EN 1092-1 (DIN 2501) / according to ASME B16.5 / JIS B2220  
→ stainless steel 1.4404/316L
- Flanges according to EN 1092-1 (DIN 2501) / according to ASME B16.5 / JIS B2220  
→ Alloy C-22 2.4602 (N 06022)

*Promass E:*

- Flanges according to EN 1092-1 (DIN 2501) / according to ASME B16.5 / JIS B2220  
→ stainless steel 1.4404/316L
- DIN 11864-2 Form A (flat flange with groove) → stainless steel 1.4404/316L
- VCO connection → stainless steel 1.4404/316L
- Threaded hygienic connections DIN 11851/ DIN 11864-1, Form A / ISO 2853 / SMS 1145  
→ stainless steel 1.4404/316L
- Tri-Clamp (OD-tubes) → stainless steel 1.4404/316L

*Promass A:*

- Mounting set for flanges EN 1092-1 (DIN 2501) / ASME B16.5 / JIS B2220  
→ stainless steel 1.4539/904L, Alloy C-22 2.4602/N 06022.  
Loose flanges → stainless steel 1.4404/316L
- VCO coupling → stainless steel 1.4539/904L, Alloy C-22 2.4602/N 06022
- Tri-Clamp (OD-tubes) (1/2") → stainless steel 1.4539/904L
- Mounting set for SWAGelok (1/4", 1/8") → stainless steel 1.4401/316
- Mounting set for NPT-F (1/4") → stainless steel 1.4539/904L/1.4539/904L,  
Alloy C-22 2.4602/N 06022

*Promass H:*

- Flanges EN 1092-1 (DIN 2501) / according to ASME B16.5 / JIS B2220  
→ stainless steel 1.4301/304, parts in contact with medium: zirconium 702/R 60702 or  
tantalum 2.5W

*Promass I:*

- Flanges EN 1092-1 (DIN 2501) / according to ASME B16.5 / JIS B2220  
→ stainless steel 1.4301/304
- DIN 11864-2 Form A (flat flange with groove) → titanium grade 2
- Threaded hygienic connection DIN 11851 / SMS 1145 → titanium grade 2
- Threaded hygienic connection ISO 2853 / DIN 11864-1 → titanium grade 2
- Tri-Clamp (OD-tubes) → titanium grade 2

*Promass S:*

- Flanges EN 1092-1 (DIN 2501) / JIS B2220 → stainless steel 1.4404/316/316L
- Flanges according to ASME B16.5 → stainless steel 1.4404/316/316L
- DIN 11864-2 Form A (flat flange with groove) → stainless steel 1.4435/316L

- Threaded hygienic connections DIN 11851/ DIN 11864-1, Form A / ISO 2853 / SMS 1145  
→ stainless steel 1.4404/316L
- Tri-Clamp (OD-Tubes) → stainless steel 1.4435/316L
- Clamp aseptic connection DIN 11864-3, Form A → stainless steel 1.4435/316L
- Clamp pipe connection DIN 32676/ISO 2852 → stainless steel 1.4435/316L

*Promass P:*

- Flanges EN 1092-1 (DIN 2501) / JIS B2220 → stainless steel 1.4404/316/316L
- Flanges according to ASME B16.5 → stainless steel 1.4404/316/316L
- DIN 11864-2 Form A (flat flange with groove), BioConnect → stainless steel 1.4435/316L
- Threaded hygienic connections DIN 11851/ DIN 11864-1, Form A / ISO 2853 / SMS 1145  
→ stainless steel 1.4435/316L
- Tri-Clamp (OD-Tubes) → stainless steel 1.4435/316L
- Clamp aseptic connection DIN 11864-3, Form A → stainless steel 1.4435/316L
- Clamp pipe connection DIN 32676/ISO 2852, BioConnect → stainless steel 1.4435/316L

*Promass O:*

- Flanges according to EN 1092-1 (DIN 2501) / according to ASME B16.5  
→ stainless steel 25Cr duplex F53/EN 1.4410 (superduplex)

*Promass X:*

- Flanges according to EN 1092-1 (DIN 2501) / according to ASME B16.5  
→ stainless steel 1.4404/316/316L

**Measuring tube(s):***Promass F:*

- DN 8 to 100 (3/8" to 4"): stainless steel 1.4539/904L; manifold: 1.4404/316L
- DN 150 (6"): stainless steel 1.4404/316L/1.4432
- DN 250 (10"): stainless steel 1.4404/316L/1.4432; manifold: CF3M
- DN 8 to 150 (3/8" to 6"): Alloy C-22 2.4602/N 06022

*Promass F (high-temperature version):*

- DN 25, 50, 80 (1", 2", 3"): Alloy C-22 2.4602/N 06022

*Promass E, S:*

- Stainless steel 1.4539/904L

*Promass A:*

- Stainless steel 1.4539/904L, Alloy C-22 2.4602/N 06022

*Promass H:*

- Zirconium 702/R 60702
- Tantalum 2.5W

*Promass I:*

- Titanium grade 9
- Titanium grade 2 (flange disks)

*Promass P:*

Stainless steel 1.4435/316L

*Promass O:*

- Stainless steel 25Cr Duplex EN 1.4410/UNS S32750 (superduplex)

*Promass X:*

- Stainless steel 1.4404/316/316L; manifold: 1.4404/316/316L

**Seals:***Promass F, E, H, I, S, P, O, X:*

Welded process connections without internal seals

*Promass A:*

Welded process connections without internal seals.

Only for mounting sets with threaded connections: Viton, EPDM, Silikon, Kalrez

---

Process connections

→ Page 138 ff.

## 10.11 Operability

Display elements	<ul style="list-style-type: none"> <li>■ Liquid crystal display: illuminated, four lines with 16 characters per line</li> <li>■ Selectable display of different measured values and status variables</li> <li>■ At ambient temperatures below <math>-20\text{ }^{\circ}\text{C}</math> (<math>-4\text{ }^{\circ}\text{F}</math>) the readability of the display may be impaired.</li> </ul>
Operating elements	<ul style="list-style-type: none"> <li>■ Local operation with three optical keys (<math>\square/\square/\square</math>)</li> <li>■ Application-specific Quick Setup menus for straightforward commissioning</li> </ul>

Language group                      Language groups available for operation in different countries:

Valid until software version 3.01.XX			
Order code	Option		Contents
Power Supply; Display	WEA	Western Europe and America	English, German, Spanish, Italian, French, Dutch and Portuguese
	EES	Eastern Europe and Scandinavia	English, Russian, Polish, Norwegian, Finnish, Swedish and Czech
	SEA	South and East Asia	English, Japanese, Indonesian
	CN	China	English, Chinese

Valid as of software version 3.07.XX		
Order code	Option	Contents
Power Supply; Display	P, Q	English, German, Spanish, Italian, French
	R, S	English, Russian, Portuguese, Dutch, Czech
	T, U	English, Japanese, Swedish, Norwegian, Finnish
	4, 5	English, Chinese, Indonesian, Polish

You can change the language group via the operating program "FieldCare".

Remote operation                      Operation by means of HART protocol

## 10.12 Certificates and approvals

CE mark	The measuring system is in conformity with the statutory requirements of the EC Directives. Endress+Hauser confirms successful testing of the device by affixing to it the CE mark.
C-tick mark	The measuring system meets the EMC requirements of the "Australian Communications and Media Authority (ACMA)".
Ex approval	Information about currently available Ex versions (ATEX, FM, CSA, IECEx, NEPSI) can be supplied by your Endress+Hauser Sales Center on request. All explosion protection data are given in a separate documentation which is also available upon request.
HART certification	The flowmeter has successfully passed all the test procedures carried out and is certified and registered by the HCF (Hart Communication Foundation). The device thus meets all the requirements of the following specifications: <ul style="list-style-type: none"> <li>■ Certified in accordance with HART Revisions 5 and 7 (device certification number: available on request)</li> </ul>

	<ul style="list-style-type: none"> <li>■ The measuring device can also be operated with certified devices of other manufacturers (interoperability).</li> </ul>
Sanitary compatibility	<ul style="list-style-type: none"> <li>■ 3A authorization (all measuring systems, except Promass H, O and X)</li> <li>■ EHEDG-tested (all measuring systems, except Promass E, H, O and X)</li> </ul>
Pressure measuring device approval	<p>The measuring devices can be ordered with or without PED (Pressure Equipment Directive). If a device with PED is required, this must be ordered explicitly. For devices with nominal diameters less than or equal to DN 25 (1"), this is neither possible nor necessary.</p> <ul style="list-style-type: none"> <li>■ With the identification PED/G1/III on the sensor nameplate, Endress+Hauser confirms conformity with the "Basic safety requirements" of Appendix I of the Pressure Equipment Directive 97/23/EC.</li> <li>■ Devices with this identification (with PED) are suitable for the following types of fluid: <ul style="list-style-type: none"> <li>– Fluids of Group 1 and 2 with a steam pressure of greater or smaller and equal than 0.5 bar (7.3 psi)</li> <li>– Unstable gases</li> </ul> </li> <li>■ Devices without this identification (without PED) are designed and manufactured according to good engineering practice. They correspond to the requirements of Art. 3, Section 3 of the Pressure Equipment Directive 97/23/EC. Their application is illustrated in Diagrams 6 to 9 in Appendix II of the Pressure Equipment Directive 97/23/EC.</li> </ul>
Functional safety	SIL -2: In accordance with IEC 61508/IEC 61511-1 (FDIS)
Other standards and guidelines	<ul style="list-style-type: none"> <li>■ EN 60529 Degrees of protection by housing (IP code).</li> <li>■ EN 61010-1 Protection Measures for Electrical Equipment for Measurement, Control, Regulation and Laboratory Procedures.</li> <li>■ IEC/EN 61326 "Emission in accordance with requirements for Class A". Electromagnetic compatibility (EMC-requirements).</li> <li>■ NAMUR NE 21 Electromagnetic compatibility (EMC) of industrial process and laboratory control equipment.</li> <li>■ NAMUR NE 43 Standardization of the signal level for the breakdown information of digital transmitters with analog output signal.</li> <li>■ NAMUR NE 53 Software of field devices and signal-processing devices with digital electronics.</li> </ul>

## 10.13 Ordering information

The Endress+Hauser service organization can provide detailed ordering information and information on the order codes on request.

## 10.14 Accessories

Various accessories, which can be ordered separately from Endress+Hauser, are available for the transmitter and the sensor →  85.

## 10.15 Supplementary Documentation

- Flow measuring technology (FA00005D)
- Description of Device Functions Promass 83 (BA00060D)
- Supplementary documentation on Ex-ratings: ATEX, FM, CSA, IECEx NEPSI
- Special Documentation
  - Functional safety manual Promass 80, 83 (SD00077D)
- Technical Information
  - Promass 80A, 83A (TI00054D)
  - Promass 80E, 83E (TI00061D)
  - Promass 80F, 83F (TI00101D)
  - Promass 80H, 83H (TI00074D)
  - Promass 80I, 83I (TI00075D)
  - Promass 80P, 83P (TI00078D)
  - Promass 80S, 83S (TI00076D)
  - Promass 83O (TI00112D)
  - Promass 83X (TI00110D)

# Index

## A

Accessories .....	85
Ambient temperature range .....	131
Applications .....	4
Applicator (selection and configuration software) .....	86
Approvals .....	10

## B

Batching .....	34
Quick Setup .....	62
Blocks .....	35

## C

Cable entries	
Degree of protection .....	30
Cable entry	
Technical data .....	110
Cable specifications (remote version) .....	26
CE mark (declaration of conformity) .....	10
Certificates .....	10
CIP cleaning .....	84
Cleaning	
CIP cleaning .....	84, 131
Exterior cleaning .....	84
SIP cleaning .....	84
Code entry (function matrix) .....	36
Commissioning	
Quick Setup .....	57
Two current outputs .....	69
Zero point adjustment .....	79
Commubox FXA195 .....	86
Commubox FXA195 (electrical connection) .....	29
Communication .....	38
Connection	
See Electrical connection	
C-tick mark .....	10
Current input	
Technical data .....	109
Current output	
Technical data .....	109
Current outputs, two	
Configuration active/passive .....	69

## D

Data back-up (of device data with T-DAT) .....	68
Declaration of conformity (CE mark) .....	10
Degree of protection .....	30, 131
Designated use .....	4
Device description files .....	39
Device designation .....	6
Device functions	
See “Description of Device Functions” manual	
Display	
Local display .....	31
Turning the display .....	24
Disposal .....	103

## E

Electrical connection	
Cable specifications (remote version) .....	26
Commubox FXA195 .....	29
Degree of protection .....	30
HART handheld terminal .....	29
Error messages	
Confirming error messages .....	37
Process error (application error) .....	93
System error (device error) .....	88
Error types (system and process errors) .....	37
European Pressure Equipment Directive .....	142
Ex approval .....	141
Exterior cleaning .....	84

## F

F-Chip .....	83
Field Xpert .....	38
Field Xpert SFX100 .....	29
FieldCare .....	39
FieldCheck (tester and simulator) .....	86
Flow direction .....	15–16
Frequency output	
Technical data .....	109
Function check .....	56
function description	
See “Description of Device Functions” manual	
Function groups .....	35
Functions .....	35
Fuse, replacing .....	102
FXA193 .....	86
FXA195 .....	86

## G

Galvanic isolation .....	109
Gas Measurement	
Quick Setup .....	66
Groups .....	35

## H

HART	
Command classes .....	38
Command No. .....	41
Electrical connection .....	29
Error messages .....	41
Handheld terminal .....	38
Hazardous substances .....	103
HOME position (display operating mode) .....	31

## I

Incoming acceptance .....	11
Inlet and outlet runs .....	131
Inlet runs .....	20
Input signal .....	109
Installation .....	131
See Installation conditions	
Installation conditions	



Dimensions	13
Inlet and outlet runs	20
Mounting location	13
Orientation (vertical, horizontal)	15
System pressure	14
Vertical pipe	14
Vibrations	20
Installation instructions	131
Special instructions for Promass F, E, H, P and S	17
Special instructions for Promass I and P with Eccentric Tri-clamps	17
Special instructions for Promass I and P with hygienic connections	18
Installing the wall-mount housing	22
Insulation of sensors	20
<b>L</b>	
Languages	141
Length of connecting cable	131
Life Cycle Management	86
Limiting flow	
See Measuring range	
Load	109
Local display	
See Display	
Low flow cutoff	109
<b>M</b>	
Maintenance	84
Material	137
Material load diagram	133
Measured variable	106
Measuring principle	106
Measuring range	106–108
Measuring system	6
Medium pressure range	133
Medium temperature range	132
<b>N</b>	
Nameplate	
Connections	9
Sensor	8
Nominal pressure	
See Medium pressure range	
<b>O</b>	
Operable flow range	108
Operating conditions	131
Operation	
Device description files	39
FieldCare	39
Function matrix	35
HART handheld terminal	38
Operational safety	5
Order code	
Accessories	85
Ordering information	142
Outlet runs	20
Output signal	109

**P**

Performance characteristic	
Promass A	111
Promass E	113
Promass F	115, 129
Promass H	118
Promass I	120
Promass O	122
Promass P	125
Promass S	127
Post-installation check (checklist)	24
Power consumption	110
Power supply (supply voltage)	110
Power supply failure	110
Pressure loss	134
Pressure measuring device approval	142
Pressure monitoring connections	83
Printed circuit boards (installation/removal)	
Field housing	98
Wall-mount housing	100
Process connections	140
Process error	
Definition	37
Process error messages	93
Programming mode	
Disabling	36
Enabling	36
Pulsating flow	
Quick Setup	60
Pulse output	
See Frequency output	
Pumps, mounting location, system pressure	14
Purge connections	83

**Q**

Quick Setup	
Batching	62
Commissioning	57
Data back-up (of device data with T-DAT)	68
Gas Measurement	66
Pulsating flow	60

**R**

Reference operating conditions	111
Registered trademarks	10
Relay output	109
Remote operation	141
Repair	103
Replacement	
Seals	84
Returning devices	103

**S**

Safety icons	5
Safety instructions	5
Sanitary compatibility	142
S-DAT (HistoROM)	83
Seals	
Material	140

Medium temperature range .....	132
Replacing, replacement seals .....	84
Secondary containment	
Gas purging, pressure monitoring connections. ....	83
Pressure range.....	133
Sensor heating .....	19
Sensor mounting	
See Sensor installation	
Signal on alarm.....	109
SIL (functional safety) .....	5, 142
SIP cleaning.....	84
Software	
Amplifier display.....	56
Versions (history) .....	103
Spare parts.....	97
Standards, guidelines .....	141
Status input	
Technical data.....	109
Storage.....	12
Supplementary Ex documentation .....	5
Supply voltage (power supply) .....	110
Switching output	
See Relay output	
System error	
Definition.....	37
System error messages.....	88
<b>T</b>	
T-DAT (HistoROM).....	83
Save/load (data back-up, e.g. for replacing devices)	68
Temperature ranges	
Ambient temperature range .....	131
Medium temperature range .....	132
Storage temperature.....	131
Thermal insulation, general notes .....	20
Transmitter	
Electrical connection.....	26
Installing the wall-mount housing.....	22
Turning the field housing (aluminum).....	21
Turning the field housing (stainless steel) .....	21
Transporting the sensor.....	11
Troubleshooting and remedy .....	87
<b>V</b>	
Vertical pipe .....	14
Vibration resistance .....	131
Vibrations .....	20, 131
<b>W</b>	
W@M.....	86
Wall-mount housing, installing .....	22
Weight.....	135
Wiring	
See Electrical connection	
<b>Z</b>	
Zero point adjustment .....	79



[www.addresses.endress.com](http://www.addresses.endress.com)

---