

Cylindrical roller bearings



6 Cylindrical roller bearings

Designs and variants	496	Mounting	512
Single row cylindrical roller bearings	496	Designation system	514
Common designs	496	Product tables	
Other designs	497	6.1 Single row cylindrical roller bearings	516
Other variants	497	6.2 High-capacity cylindrical roller bearings	550
High-capacity cylindrical roller bearings	498	6.3 Single row full complement cylindrical roller bearings	554
Bearings with an inner ring centred cage	499	6.4 Double row full complement cylindrical roller bearings	564
Bearings with an outer ring centred cage	499	6.5 Sealed double row full complement cylindrical roller bearings	576
Separable bearings with an inner ring raceway centred cage	499		
Double row bearings	499		
Single row full complement cylindrical roller bearings ..	500		
NCF design bearings	500		
NJG design bearings	500		
Double row full complement cylindrical roller bearings ..	500		
NNCL design bearings	501		
NNCF design bearings	501		
NNC design bearings	501		
NNF design sealed bearings	501		
SKF Explorer bearings	502		
Matched bearings	502		
Cages	502		
Bearing data	504		
(Dimension standards, tolerances, radial internal clearance, axial clearance, permissible misalignment, permissible axial displacement)			
Loads	509	Other cylindrical roller bearings	
(Minimum load, equivalent dynamic bearing load, equivalent static bearing load)		Bearings with Solid Oil	1023
Dynamic axial load carrying capacity	510	INSOCOAT bearings	1029
Permissible axial loads	510	Hybrid bearings	1043
		NoWear coated bearings	1059
		Super-precision bearings	→ skf.com/super-precision
Temperature limits	511	Double and four-row cylindrical roller bearings	→ skf.com/bearings
		Split cylindrical roller bearings	→ skf.com/bearings
Permissible speed	511	Backing bearings	→ skf.com/bearings
		Indexing roller units	→ skf.com/bearings
Design considerations	512	Cylindrical roller bearings and bearing units	
Flange support	512	for railway applications	→ contact SKF



6 Cylindrical roller bearings



More information

General bearing knowledge	17
Bearing selection process	59
Lubrication	109
Bearing interfaces	139
Seat tolerances for standard conditions	148
Selecting internal clearance	182
Sealing, mounting and dismounting	193

Mounting instructions for individual bearings → skf.com/mount

SKF bearing maintenance handbook ISBN 978-91-978966-4-1

SKF cylindrical roller bearings are available in many designs, series and sizes. The major design differences between the cylindrical roller bearings presented in this catalogue are in:

- the number of roller rows (one or two)
- the type of cage (with, without or special designs)
 - Bearings with a cage can accommodate heavy radial loads and peak loads, rapid accelerations and high speeds.
 - Full complement bearings (without cage) incorporate a maximum number of rollers and are therefore suitable for very heavy radial loads at moderate speeds.
 - SKF high-capacity cylindrical roller bearings combine the high load carrying capacity of a full complement bearing with the high speed capability of a bearing with cage.
- the configuration of the inner and outer ring flanges (position and number of guide flanges, **fig. 1**)

Bearing features

- **High load carrying capacity**
- **High stiffness**
- **Accommodate axial displacement (fig. 2)**
Except for bearings with flanges on both the inner and outer rings.
- **Low friction**
The open flange design (**fig. 3**), together with the roller end design and surface finish, promote lubricant film formation resulting in lower friction and higher axial load carrying capacity.
- **Long service life**
The logarithmic roller profile reduces edge stresses at the roller/raceway contact (**fig. 4**) and sensitivity to misalignment and shaft deflection.

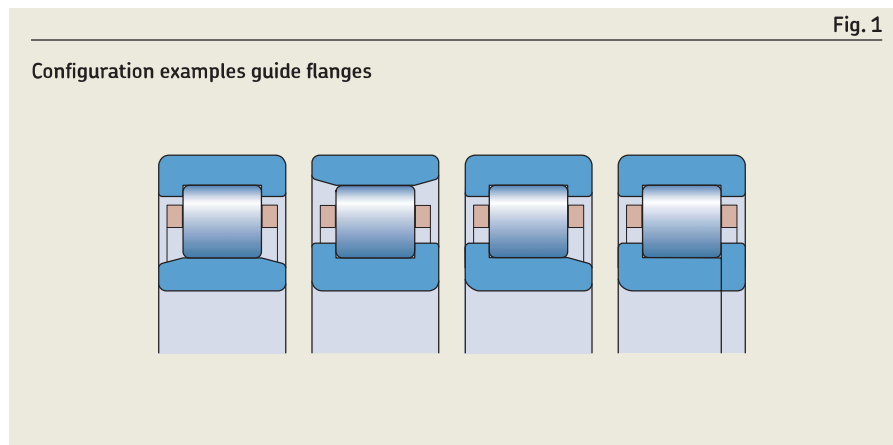

- **Enhanced operational reliability**

The surface finish on the contact surfaces of the rollers and raceways supports the formation of a hydrodynamic lubricant film.

- **Separable and interchangeable**

The separable components of SKF cylindrical roller bearings are interchangeable (fig. 5). This facilitates mounting and dismounting, as well as maintenance inspections.

In addition to the cylindrical roller bearings presented in this catalogue, SKF supplies cylindrical roller bearings for special application requirements. This assortment includes:

- *Double row cylindrical roller bearings* → skf.com/bearings
- *Four-row cylindrical roller bearings* → skf.com/bearings
- *Split cylindrical roller bearings* → skf.com/bearings
- *Super-precision bearings* → skf.com/super-precision
- *Backing bearings* → skf.com/bearings
- *Indexing roller units* → skf.com/bearings
- Cylindrical roller bearings and bearing units for railway applications → contact SKF

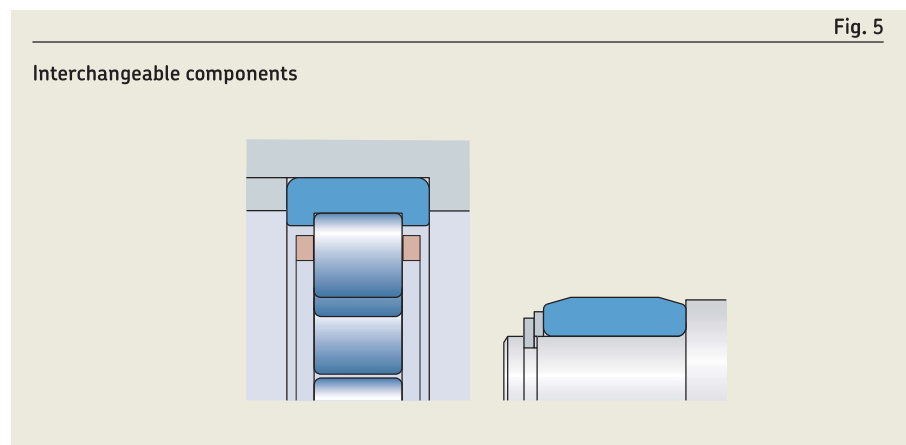
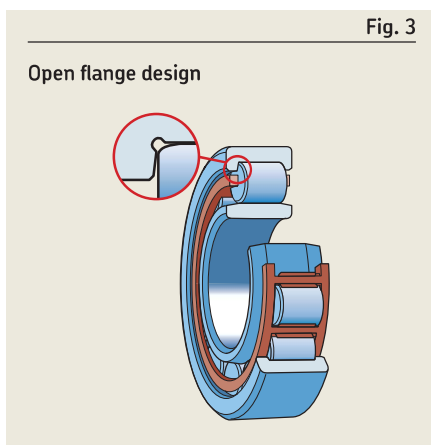
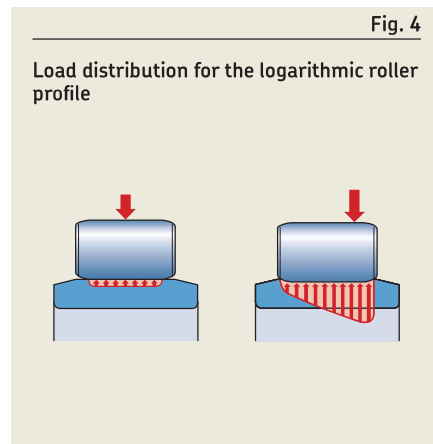
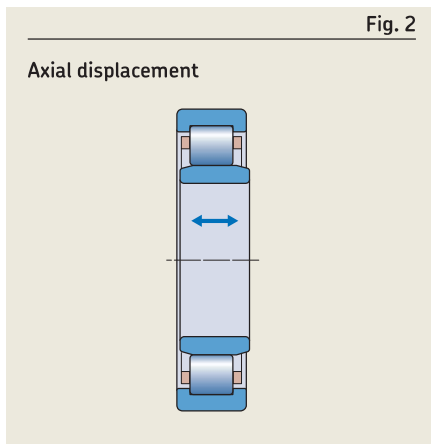

Designs and variants

Single row cylindrical roller bearings

The major design differences between the single row cylindrical roller bearings presented in this catalogue are in:

- the cage design and material
- the configuration of the inner and outer ring flanges

SKF inch bearings (CRL and CRM series, skf.com/go/17000-6-1), which are not presented in this catalogue, conform to the metric N design (fig. 6). They are mainly used in the aftermarket and, therefore, SKF recommends not to use these bearings for new bearing arrangement designs.

6



Common designs

The most common designs of single row cylindrical roller bearings are shown in fig. 6.

NU design bearings

- have two integral flanges on the outer ring and no flanges on the inner ring
- can accommodate axial displacement of the shaft relative to the housing in both directions
- can be used together with an appropriate angle ring to stabilize the bearing in the axial direction (fig. 7, *Appropriate angle rings*)

N design bearings

- have two integral flanges on the inner ring and no flanges on the outer ring
- can accommodate axial displacement of the shaft relative to the housing in both directions

NJ design bearings

- have two integral flanges on the outer ring and one on the inner ring
- can accommodate axial displacement of the shaft relative to the housing in one direction only
- are used to locate the shaft axially in one direction
- can be used together with an appropriate angle ring to stabilize the bearing in the other axial direction (fig. 8, *Appropriate angle rings*)

NUP design bearings

- have two integral flanges on the outer ring and one integral flange and one non-integral flange, i.e. a loose flange ring, on the inner ring
- are used to locate the shaft axially in both directions

Appropriate angle rings (thrust collars)

- are used with NU design bearings to locate the shaft axially in one direction (fig. 7)
Angle rings should not be used on both sides of NU design bearings as this can lead to axial clamping of the rollers.
- are used with NJ design bearings to locate the shaft axially in both directions (fig. 8)
- are made of carbon chromium steel
- are hardened and ground
- have a maximum axial run-out that is in accordance with the Normal tolerance class for the appropriate bearing
- are identified by the series designation HJ followed by the appropriate bearing dimension series and size
- are available as listed in the [product table, page 517](#)
- must be ordered separately

Fig. 7

NU design bearing + HJ angle ring

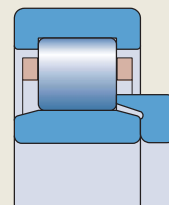
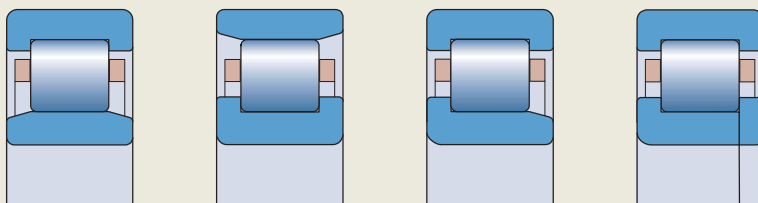

Fig. 6

Common designs



NU

N

NJ

NUP

Fig. 8

NJ design bearing + HJ angle ring

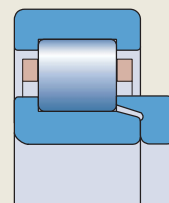

Reasons to design angle rings into a bearing arrangement include:

- no NJ or NUP design locating bearings in the product range
- to provide an extend inner ring seat for heavily loaded bearings in the locating position:
 - full width inner ring seat of NJ design bearings with an HJ angle ring compared to NUP design bearings having a shorter inner ring and a loose flange
- to simplify design or mounting procedures

Other designs

For the assortment of other design bearings (fig. 9), visit skf.com/go/17000-6-1.

NUB design bearings

- have two integral flanges on the outer ring and no flanges on the inner ring that is extended on both sides
- can accommodate axial displacement of the shaft relative to the housing in both directions

NJP design bearings

- have two integral flanges on the outer ring and one non-integral flange, i.e. a loose flange ring, on the inner ring
- are used to locate the shaft axially in one direction

NF design bearings

- have two integral flanges on the inner ring and one integral flange on the outer ring
- are used to locate the shaft axially in one direction

NP design bearings

- have two integral flanges on the inner ring and one integral flange and one non-integral flange, i.e. a loose flange ring, on the outer ring
- are used to locate the shaft axially in both directions

Other variants

Bearings without an inner or outer ring

- are available based on:
 - NU design bearings without an inner ring (RNU series, fig. 10)
 - enable the shaft diameter to be larger to provide a stronger, stiffer shaft
 - provide inside diameter F_w tolerance limits to be within F6 \oplus when the rollers are in contact with the outer ring raceway
 - are listed online for certain sizes (skf.com/go/17000-6-6)
 - N design bearings without an outer ring (RN series, fig. 11)
- can accommodate axial displacement of the shaft relative to the housing, limited by the width of the raceway:
 - on the shaft for RNU bearings
 - in the housing for RN bearings
- are typically used in applications where hardened and ground raceways can be machined on the shaft or in the housing (*Raceways on shafts and in housings*, page 179)

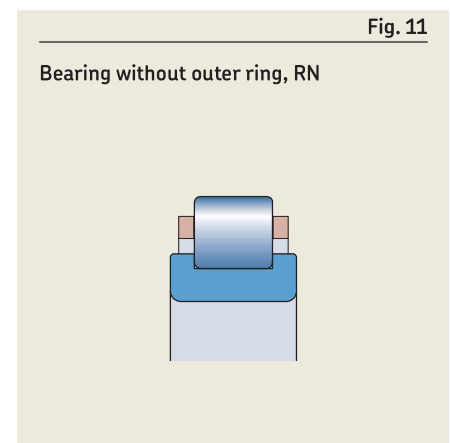
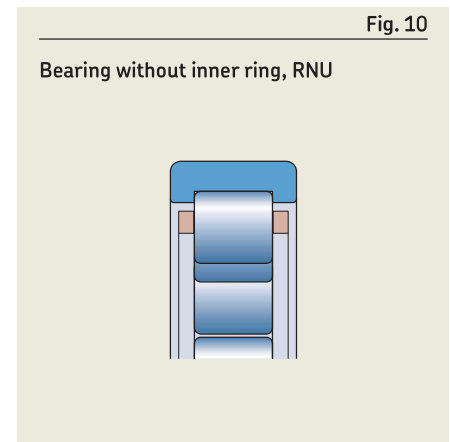
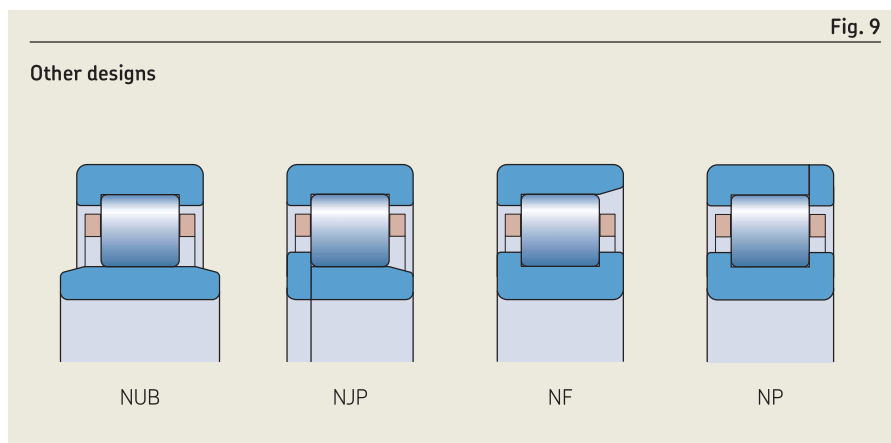

6 Cylindrical roller bearings

Bearings with a tapered bore

- are available with a 1:12 tapered bore (designation suffix K, [fig. 12](#))
- have radial internal clearance greater than corresponding bearings with a cylindrical bore

Bearings with a snap ring groove in the outer ring

- are identified by the designation suffix N ([fig. 13](#))
- can be axially located in the housing by a snap ring:
 - to save space
 - to reduce mounting time

Bearings with locating slots in the outer ring

- are available with one or two locating slots (designation suffix N1 or N2, [fig. 14](#))
 - The two locating slots are positioned 180° apart.
- can be used to prevent the outer ring from turning where it must be mounted with a loose fit

High-capacity cylindrical roller bearings

SKF high-capacity cylindrical roller bearings ([fig. 15](#)) are designed for applications such as industrial gearboxes, wind turbine gearboxes and mining equipment.

The cage bars are displaced relative to the roller pitch diameter to enable the rollers to be placed closer to each other, creating room for additional rollers ([fig. 16](#)) and thereby increasing load carrying capacity and radial stiffness.

The black oxide coating of rings and rollers (designation suffix L4B) contributes to extended service life by improving:

- smearing damage resistance
- running-in properties and reducing friction
- performance under poor lubrication conditions
- chemical resistance (from aggressive oil additives)
- corrosion resistance

SKF high-capacity cylindrical roller bearings are available in three different main designs and some variants.

6



Fig. 12

Bearing with a tapered bore

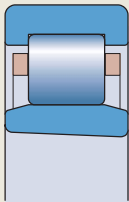

Fig. 14

Bearing with locating slot(s)

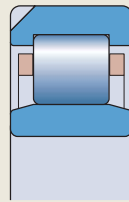

Fig. 15

High-capacity bearing

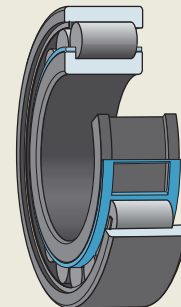

Fig. 13

Bearing with a snap ring groove

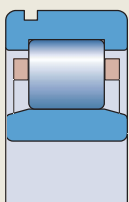
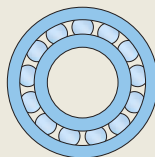
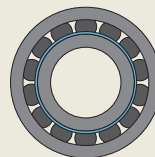

Fig. 16

Roller distances



Roller distance of a standard bearing with cage (cage not shown)



High-capacity bearing with inner ring centred cage

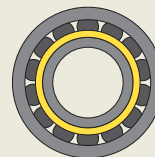

Separable high-capacity bearing with inner ring raceway centred cage

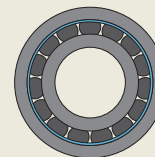

High-capacity bearing with outer ring centred cage

Bearings with an inner ring centred cage

- are identified by the series designation NCF .. ECJB (fig. 17)
- are used to locate the shaft axially in one direction and eventually to accommodate axial displacement of the shaft relative to the housing in the opposite direction
- can be supplied without an outer ring (RN .. ECJB series, fig. 17), where the outer raceway is integrated into the application (*Raceways on shafts and in housings*, page 179)

Bearings with an outer ring centred cage

- are identified by the series designation NJF .. ECJA (fig. 18)
- for some sizes, contain more rollers than same-sized bearings with an inner ring centred cage
- are used to locate the shaft axially in one direction and eventually to accommodate axial displacement of the shaft relative to the housing in the opposite direction
- can be supplied without an inner ring (RNU .. ECJA series, fig. 18), where the inner raceway is integrated into the application (*Raceways on shafts and in housings*, page 179)

Separable bearings with an inner ring raceway centred cage

- are identified by the series designation NUH .. ECMH (fig. 19)
- can accommodate axial displacement of the shaft relative to the housing in both directions
- can be separated (outer ring with the roller and cage assembly from the inner ring), which simplifies mounting and dismounting, particularly where load conditions require both rings to have an interference fit

Double row bearings

- are available on request

6

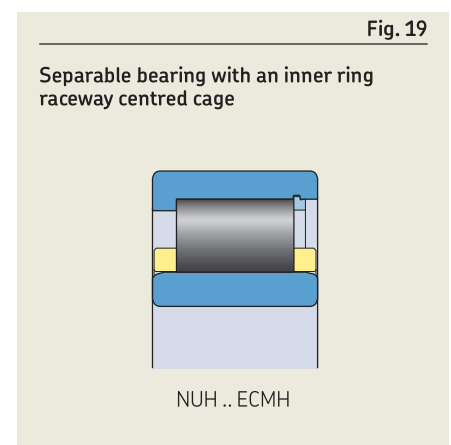
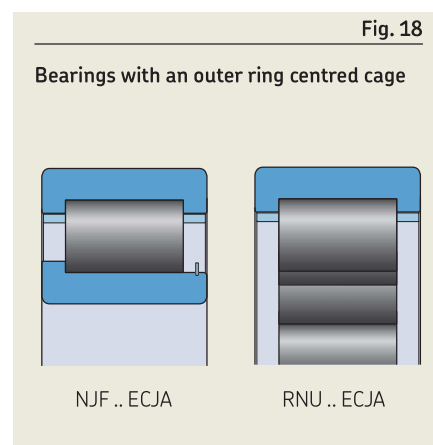
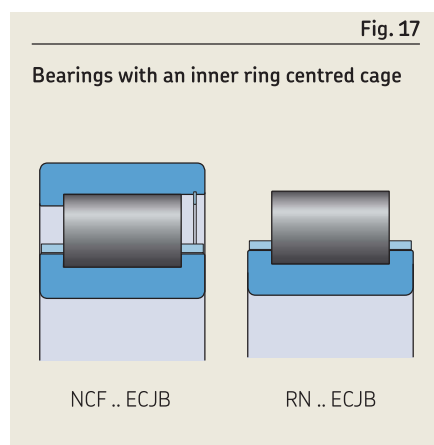

Single row full complement cylindrical roller bearings

SKF single row full complement cylindrical roller bearings are suitable for very heavy radial loads and provide increased radial stiffness.

The basic SKF assortment of single row full complement cylindrical roller bearings provided in this catalogue includes NCF and NJG design bearings (fig. 20). They are used to locate the shaft axially in one direction and eventually to accommodate axial displacement of the shaft relative to the housing in the opposite direction.

NCF design bearings

- have two integral flanges on the inner ring and one on the outer ring
- have a retaining ring in the outer ring, on the side opposite the integral flange, to hold the bearing together

The retaining ring should not be loaded axially during operation.

NJG design bearings

- comprise the heavy 23 dimension series
- are intended for very heavily loaded, low-speed applications
- have two integral flanges on the outer ring and one on the inner ring
- have a self-retaining roller complement

Therefore, the outer ring with the roller complement can be separated from the inner ring without having to take special precautions to prevent the rollers from falling out (fig. 21). This simplifies mounting and dismounting.

Double row full complement cylindrical roller bearings

SKF double row full complement cylindrical roller bearings are, because of their second row of rollers, suitable for very heavy radial loads and provide increased radial stiffness.

The basic SKF assortment provided in this catalogue includes (fig. 22):

- three different designs of open bearings:
 - NNCL design
 - NNCF design
 - NNC design
- NNF design sealed bearings

SKF double row full complement cylindrical roller bearings are non-separable and have an annular groove and lubrication holes in the outer ring to facilitate lubrication. NNF design bearings have additional lubrication holes in the inner ring.

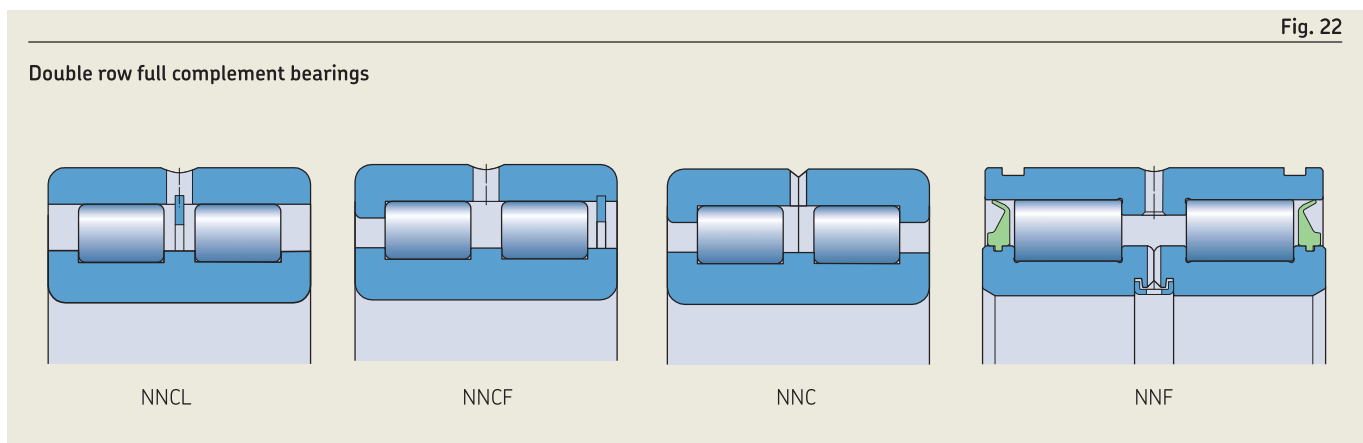
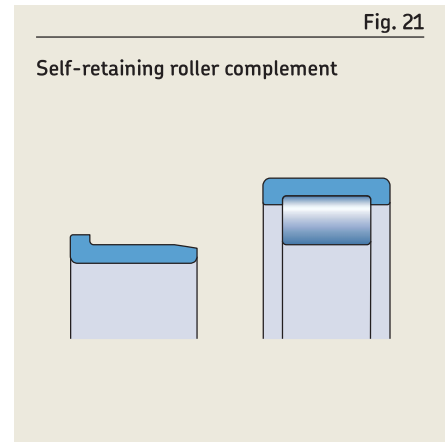
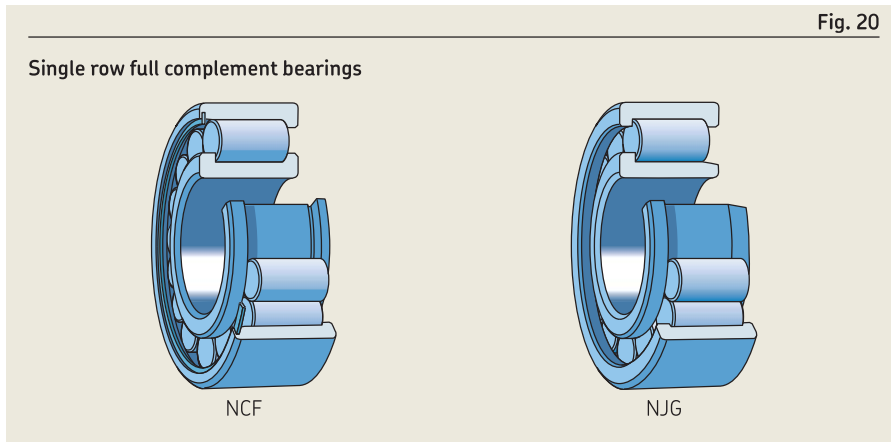

NNCL design bearings

- have three integral flanges on the inner ring and no flanges on the outer ring
- have a retaining ring in the outer ring between the roller rows to hold the bearing together

The retaining ring should not be loaded axially during operation.
- can accommodate axial displacement of the shaft relative to the housing in both directions

NNCF design bearings

- have three integral flanges on the inner ring and one on the outer ring
- have a retaining ring in the outer ring, on the side opposite the integral flange, to hold the bearing together

The retaining ring should not be loaded axially during operation.
- are used to locate the shaft axially in one direction and eventually to accommodate axial displacement of the shaft relative to the housing in the opposite direction

NNC design bearings

- have the same inner ring as NNCL and NNCF design bearings
- have a two-piece outer ring:
 - held together by retaining elements, which should never be loaded axially
 - consisting of two identical outer ring parts with one integral flange on each
- are used to locate the shaft axially in both directions

Alternative NNC design bearings may consist of a one-piece outer ring with one integral flange and a flange ring.

NNF design sealed bearings

- comprise the 50 and 3194.. series
- have a two-piece inner ring:
 - held together by a retaining ring
 - with three integral flanges
- have one integral central flange on the outer ring
- are used to locate the shaft axially in both directions
- can accommodate tilting moments because of the distance between the two rows of rollers
- have an outer ring that is 1 mm narrower than the inner ring
- do not require spacer rings between the inner ring and adjacent components, in applications with a rotating outer ring
- have two snap ring grooves in the outer ring:
 - to simplify mounting
 - to save space axially

This is especially valuable where the bearing is mounted in/on an adjacent component, e.g. in rope sheaves (fig. 23).
- have a PUR contact seal on both sides, fitted in a recess on the inner ring shoulder (fig. 22)

The seal lip exerts slight pressure against the outer ring raceway.
- are filled with a high-quality grease with good rust-inhibiting properties (table 1, page 503)

For additional information about greases, refer to *Lubrication*, page 109.
- can be supplied open and without grease, for applications where oil lubrication is to be used

If a small quantity of bearings without seals is required, the seals can be removed and the bearings can be washed prior to mounting.

6



Fig. 23

NNF design sealed bearing in a rope sheave

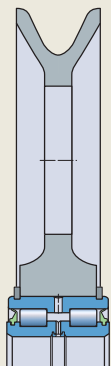

SKF Explorer bearings

Single row and high-capacity bearings are also available as SKF Explorer bearings (page 7).

Matched bearings

- are combined so that any difference in cross-sectional height of the bearings used in a matched set lies within a very small tolerance range
 - This tighter tolerance is a precondition for equal load sharing between the bearings.
- can be supplied as:
 - sets of two bearings (designation suffix DR)
 - sets of three bearings (designation suffix TR)
 - sets of four bearings (designation suffix QR)

Cages

SKF single row and high-capacity cylindrical roller bearings are fitted with one of the cages shown in table 2.

When used at high temperatures, some lubricants can have a detrimental effect on polyamide cages. For additional information about the suitability of cages, refer to Cages, page 187.



Cages for cylindrical roller bearings

Single row bearings

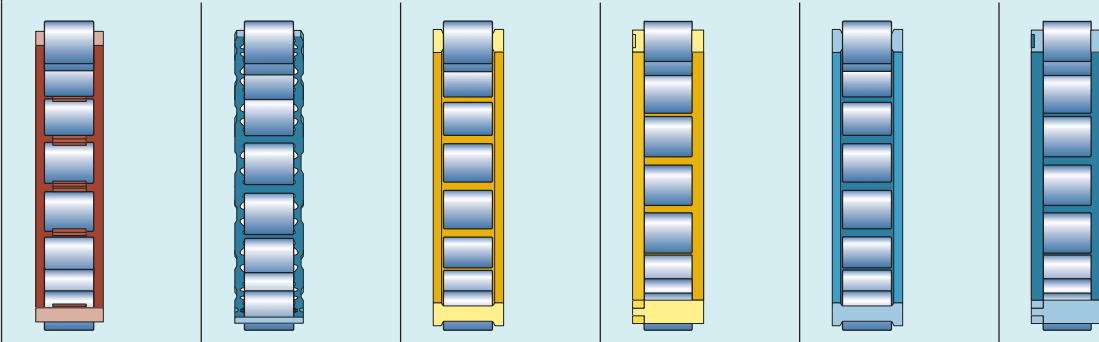

Cage type	Window-type <ul style="list-style-type: none"> • roller centred • outer ring centred 	Window-type, roller centred	Window-type, inner or outer ring centred (depending on bearing design)	Riveted <ul style="list-style-type: none"> • roller centred • outer ring centred • inner ring centred 	Window-type, inner or outer ring centred (depending on bearing design)	Riveted <ul style="list-style-type: none"> • roller centred • outer ring centred • inner ring centred
Material	<ul style="list-style-type: none"> • PA66, glass fibre reinforced • PEEK, glass fibre reinforced 	Stamped steel	Machined brass	Machined brass	Machined light alloy	Machined light alloy
Suffix	<ul style="list-style-type: none"> • P or PH • PA or PHA 	<ul style="list-style-type: none"> • – • J 	<ul style="list-style-type: none"> • ML 	<ul style="list-style-type: none"> • M • MA • MB 	<ul style="list-style-type: none"> • LL 	<ul style="list-style-type: none"> • L • LA • LB

Table 1

Technical specifications of SKF standard grease for sealed double row full complement cylindrical roller bearings

Grease	Temperature range ¹⁾		Thickener	Base oil type	NLGI grade	Base oil viscosity [mm ² /s]	
	at 40 °C (105 °F)	at 100 °C (210 °F)					
GHU			Lithium complex soap	Mineral	2	150	15

¹⁾ Refer to the SKF traffic light concept (page 117).

Table 2

High-capacity bearings

Window-type, inner ring centred	Window-type, outer ring centred	Window-type, inner ring raceway centred
Sheet steel, manganese phosphated	Sheet steel, manganese phosphated	Machined brass
JB	JA	MH



Bearing data

	Single row bearings	High-capacity bearings
Dimension standards	Boundary dimensions: ISO 15 Except for: <ul style="list-style-type: none"> • HJ angle rings: ISO 246 • Snap rings and grooves: ISO 464 • Locating slots: ISO 20515 	Boundary dimensions: ISO 15
Tolerances For additional information → page 35	Normal dimensional tolerance P6 geometrical tolerance Check availability of P5 or P6 tolerance class for bearings in the 10 series Values: ISO 492 (table 2, page 38 , to table 4, page 40)	Normal dimensional tolerance P6 geometrical tolerance
Radial internal clearance For additional information → page 182	Normal, C3 Check availability of other clearance classes Values: ISO 5753-1 (table 3, page 506) Values are valid for unmounted bearings under zero measuring load.	
Axial internal clearance	Guideline values: <ul style="list-style-type: none"> • NUP design (table 4, page 507) • NJ design with an HJ angle ring (table 5, page 508) When measuring the axial internal clearance, the rollers may tilt, causing an enlargement of the measured axial clearance: <ul style="list-style-type: none"> • 10, 18, 19, 2, 3 and 4 series: ≈ the radial internal clearance • 22, 23, 29 and 39 series: ≈ 2/3 the radial internal clearance 	–
Permissible misalignment	<ul style="list-style-type: none"> • 10, 12, 18, 19, 2, 3 and 4 series: ≈ 4 minutes of arc • 20, 22, 23, 29 and 39 series: ≈ 3 minutes of arc The values are not valid for bearings of the NUP design or the NJ design with an HJ angle ring. Misalignment increases bearing noise and reduces bearing service life, and ...	≈ 3 minutes of arc
Permissible axial displacement (fig. 2, page 495)	s_{\max} → product tables, page 516	page 550
	Bearings having no flange, or only one integral flange on either the inner or outer ring, can accommodate axial displacement. Displacement of the shaft ...	



Single row full complement bearings	Double row full complement bearings
Boundary dimensions: ISO 15	Boundary dimensions: ISO 15 Except for: <ul style="list-style-type: none"> • outer ring width of NNF 50 series bearings: C = 1 mm smaller than ISO standard • bearings in the 3194.. series: dimensions not standardized
Normal	
<div style="border: 1px solid black; height: 278px; width: 100%;"></div>	
<ul style="list-style-type: none"> • 18 series: ≈ 4 minutes of arc • 22, 23, 28, 29 and 30 series: ≈ 3 minutes of arc <p>... when it exceeds the guideline values these effects become particularly noticeable.</p>	<p>For information, contact the SKF application engineering service.</p>
<p>page 554</p> <p>... relative to the housing occurs within these bearings. As a result, there is virtually no increase in friction.</p>	<p>page 564</p>

Radial internal clearance of cylindrical roller bearings with a cylindrical bore

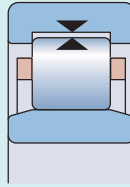

Bore diameter		Radial internal clearance									
d		C2		Normal		C3		C4		C5	
>	≤	min.	max.	min.	max.	min.	max.	min.	max.	min.	max.
mm		μm									
-	24	0	25	20	45	35	60	50	75	65	90
24	30	0	25	20	45	35	60	50	75	70	95
30	40	5	30	25	50	45	70	60	85	80	105
40	50	5	35	30	60	50	80	70	100	95	125
50	65	10	40	40	70	60	90	80	110	110	140
65	80	10	45	40	75	65	100	90	125	130	165
80	100	15	50	50	85	75	110	105	140	155	190
100	120	15	55	50	90	85	125	125	165	180	220
120	140	15	60	60	105	100	145	145	190	200	245
140	160	20	70	70	120	115	165	165	215	225	275
160	180	25	75	75	125	120	170	170	220	250	300
180	200	35	90	90	145	140	195	195	250	275	330
200	225	45	105	105	165	160	220	220	280	305	365
225	250	45	110	110	175	170	235	235	300	330	395
250	280	55	125	125	195	190	260	260	330	370	440
280	315	55	130	130	205	200	275	275	350	410	485
315	355	65	145	145	225	225	305	305	385	455	535
355	400	100	190	190	280	280	370	370	460	510	600
400	450	110	210	210	310	310	410	410	510	565	665
450	500	110	220	220	330	330	440	440	550	625	735
500	560	120	240	240	360	360	480	480	600	690	810
560	630	140	260	260	380	380	500	500	620	780	900
630	710	145	285	285	425	425	565	565	705	865	1005
710	800	150	310	310	470	470	630	630	790	975	1135
800	900	180	350	350	520	520	690	690	860	1095	1265
900	1000	200	390	390	580	580	770	770	960	1215	1405
1000	1120	220	430	430	640	640	850	850	1060	1355	1565
1120	1250	230	470	470	710	710	950	950	1190	1510	1750
1250	1400	270	530	530	790	790	1050	1050	1310	1680	1940
1400	1600	330	610	610	890	890	1170	1170	1450	1920	2200
1600	1800	380	700	700	1020	1020	1340	1340	1660	2160	2480
1800	2000	400	760	760	1120	1120	1480	1480	1840	2390	2760



Table 4

Axial internal clearance of NUP cylindrical roller bearings

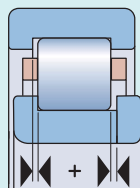

Bearing Bore diameter	Size code	Axial internal clearance of bearings in the series							
		NUP 2		NUP 3		NUP 22		NUP 23	
		min.	max.	min.	max.	min.	max.	min.	max.
mm	–	μm							
17	03	37	140	37	140	37	140	47	155
20	04	37	140	37	140	47	155	47	155
25	05	37	140	47	155	47	155	47	155
30	06	37	140	47	155	47	155	47	155
35	07	47	155	47	155	47	155	62	180
40	08	47	155	47	155	47	155	62	180
45	09	47	155	47	155	47	155	62	180
50	10	47	155	47	155	47	155	62	180
55	11	47	155	62	180	47	155	62	180
60	12	47	155	62	180	62	180	87	230
65	13	47	155	62	180	62	180	87	230
70	14	47	155	62	180	62	180	87	230
75	15	47	155	62	180	62	180	87	230
80	16	47	155	62	180	62	180	87	230
85	17	62	180	62	180	62	180	87	230
90	18	62	180	62	180	62	180	87	230
95	19	62	180	62	180	62	180	87	230
100	20	62	180	87	230	87	230	120	315
105	21	62	180	–	–	–	–	–	–
110	22	62	180	87	230	87	230	120	315
120	24	62	180	87	230	87	230	120	315
130	26	62	180	87	230	87	230	120	315
140	28	62	180	87	230	87	230	120	315
150	30	62	180	–	–	87	230	120	315
160	32	87	230	–	–	–	–	–	–
170	34	87	230	–	–	–	–	–	–
180	36	87	230	–	–	–	–	–	–
190	38	87	230	–	–	–	–	–	–
200	40	87	230	–	–	–	–	–	–
220	44	95	230	–	–	–	–	–	–
240	48	95	250	–	–	–	–	–	–
260	52	95	250	–	–	–	–	–	–

Axial internal clearance of NJ + HJ cylindrical roller bearings

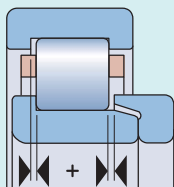

Bearing Bore diameter	Size code	Axial internal clearance of bearings in the series									
		NJ 2 + HJ 2		NJ 3 + HJ 3		NJ 4 + HJ 4		NJ 22 + HJ 22		NJ 23 + HJ 23	
		min.	max.	min.	max.	min.	max.	min.	max.	min.	max.
mm	–	µm									
20	04	42	165	42	165	–	–	52	185	52	183
25	05	42	165	52	185	–	–	52	185	52	183
30	06	42	165	52	185	60	200	52	185	52	183
35	07	52	185	52	185	60	200	52	185	72	215
40	08	52	185	52	185	60	200	52	185	72	215
45	09	52	185	52	185	60	200	52	185	72	215
50	10	52	185	52	185	80	235	52	185	72	215
55	11	52	185	72	215	80	235	52	185	72	215
60	12	52	185	72	215	80	235	72	215	102	275
65	13	52	185	72	215	80	235	72	215	102	275
70	14	52	185	72	215	80	235	72	215	102	275
75	15	52	185	72	215	80	235	72	215	102	275
80	16	52	185	72	215	80	235	72	215	102	275
85	17	72	215	72	215	110	290	72	215	102	275
90	18	72	215	72	215	110	290	72	215	102	275
95	19	72	215	72	215	110	290	72	215	102	275
100	20	72	215	102	275	110	290	102	275	140	375
105	21	72	215	102	275	110	290	102	275	140	375
110	22	72	215	102	275	110	290	102	275	140	375
120	24	72	215	102	275	110	310	102	275	140	375
130	26	72	215	102	275	110	310	102	275	140	375
140	28	72	215	102	275	140	385	102	275	140	375
150	30	72	215	102	275	140	385	102	275	140	375
160	32	102	275	102	275	–	–	140	375	140	375
170	34	102	275	–	–	–	–	140	375	–	–
180	36	102	275	–	–	–	–	140	375	–	–
190	38	102	275	–	–	–	–	–	–	–	–
200	40	102	275	–	–	–	–	–	–	–	–
220	44	110	290	–	–	–	–	–	–	–	–
240	48	110	310	–	–	–	–	–	–	–	–
260	52	110	310	–	–	–	–	–	–	–	–
280	56	110	310	–	–	–	–	–	–	–	–



Loads

	Single row, high-capacity and single row full complement bearings	Double row full complement bearings	
<p>Minimum load</p> <p>For additional information → page 106</p>	$F_{rm} = k_r \left(6 + \frac{4 n}{n_r} \right) \left(\frac{d_m}{100} \right)^2$		<p>Symbols</p> <p>d_m bearing mean diameter [mm] = 0,5 (d + D)</p> <p>e limiting value = 0,2 for bearings in the 10, 18, 19, 2, 3 and 4 series = 0,3 for bearings in the 12, 20, 22, 23, 28, 29, 30 and 39 series</p> <p>F_a axial load [kN] F_r radial load [kN] F_{rm} minimum radial load [kN] k_r minimum load factor (product tables, page 516)</p> <p>n rotational speed [r/min] n_r reference speed [r/min] (product tables) For sealed double row full complement bearings with seals removed and oil lubrication → 1,3 times the limiting speed</p> <p>P equivalent dynamic bearing load [kN] P_0 equivalent static bearing load [kN] Y axial load factor = 0,6 for bearings in the 10, 18, 19, 2, 3 and 4 series = 0,4 for bearings in the 12, 20, 22, 23, 28, 29, 30 and 39 series</p>
<p>Equivalent dynamic bearing load</p> <p>For additional information → page 91</p>	<p>Non-locating bearings $P = F_r$</p> <p>Locating bearings $F_a/F_r \leq e \rightarrow P = F_r$ $F_a/F_r > e \rightarrow P = 0,92 F_r + Y F_a$ F_a must not exceed 0,5 F_r.</p>	<p>$F_a/F_r \leq 0,15 \rightarrow P = F_r$ $F_a/F_r > 0,15 \rightarrow P = 0,92 F_r + 0,4 F_a$ F_a must not exceed 0,25 F_r.</p>	
<p>Equivalent static bearing load</p> <p>For additional information → page 105</p>	$P_0 = F_r$		



Dynamic axial load carrying capacity

Cylindrical roller bearings with flanges on both the inner and outer rings can support, in addition to radial loads, axial loads up to:

- $F_a \leq 0,25 F_r$ for double row full complement bearings
- $F_a \leq 0,5 F_r$ for other design bearings

The axial load carrying capacity is determined by the lubrication condition, operating temperature and heat dissipation at the roller end / flange contact.

The formulae below are valid for normal operating conditions:

- $\Delta T \approx 60 \text{ }^\circ\text{C}$ between the bearing operating and ambient temperature
- specific heat loss $\approx 0,5 \text{ mW/mm}^2$
- viscosity ratio $\kappa \geq 2$
- misalignment ≤ 1 minute of arc

For misalignment > 1 minute of arc, contact the SKF application engineering service.

Permissible axial loads

Conditions	Mechanical limitations	Thermal limitations	Symbols
Continuous	<p>Bearings in the 2.. series $F_{ap \text{ max}} \leq 0,0045 D^{1,5}$</p> <p>Bearings in other series $F_{ap \text{ max}} \leq 0,0023 D^{1,7}$</p> <p>High-capacity bearings $F_{ap \text{ max}} \leq 0,0035 D^{1,7}$</p>	<p>Circulating oil lubrication</p> $F_{ap \text{ oil}} = F_{ap} + \frac{15 \times 10^4 k_1 \Delta T_s V_s}{n (d + D)}$ <p>Other lubrication</p> <ul style="list-style-type: none"> • Reference surface $A \leq 50\,000 \text{ mm}^2$ $F_{ap} = \frac{k_1 C_0 10^4}{n (d + D)} - k_2 F_r$ <ul style="list-style-type: none"> • Reference surface $A > 50\,000 \text{ mm}^2$ $F_{ap} = \frac{7,5 k_1 C_0^{2/3} 10^4}{n (d + D)} - k_2 F_r$	<p>A reference surface [mm^2] $= \pi B (D + d)$</p> <p>B bearing width [mm]</p> <p>C_0 basic static load rating [kN] (product tables, page 516)</p> <p>d bearing bore diameter [mm]</p> <p>D bearing outside diameter [mm]</p> <p>ΔT_s temperature difference between incoming and outgoing oil flow [$^\circ\text{C}$]</p> <p>F_a axial load [kN]</p> <p>F_{ap} permissible axial load [kN]</p> <p>$F_{ap \text{ brief}}$ maximal axial load for brief periods [kN]</p> <p>$F_{ap \text{ max}}$ maximal constantly acting axial load [kN]</p> <p>$F_{ap \text{ oil}}$ maximum permissible axial load in circulating oil applications [kN]</p> <p>$F_{ap \text{ peak}}$ maximal occasional axial peak load [kN]</p> <p>F_r radial load [kN]</p> <p>k_1, k_2 lubrication factors (table 6)</p> <p>n rotational speed [r/min]</p> <p>V_s amount of oil flow [l/min]</p>
Brief periods	<p>$F_{ap \text{ brief}} \leq 2 (F_{ap}, F_{ap \text{ oil}}, F_{ap \text{ max}})$</p> <ul style="list-style-type: none"> • provided it does not increase the bearing operating temperature $> 5 \text{ }^\circ\text{C}$ temporarily • “brief period” is the approximate time for 1 000 revolutions to take place 		
Occasional peak loads	<p>High-capacity bearings $F_{ap \text{ peak}} \leq 0,0085 D^{1,7}$</p> <p>Other bearings $F_{ap \text{ peak}} \leq 3 (F_{ap}, F_{ap \text{ oil}}, F_{ap \text{ max}})$</p>		



Temperature limits

The permissible operating temperature for cylindrical roller bearings can be limited by:

- the dimensional stability of the bearing rings and rollers
- the cage
- the seals
- the lubricant

Where temperatures outside the permissible range are expected, contact SKF.

Bearing rings and rollers

SKF cylindrical roller bearings are heat stabilized up to 150 °C (300 °F).

Cages

Steel, brass, light alloy or PEEK cages can be used at the same operating temperatures as the bearing rings and rollers. For temperature limits of cages made of other polymer materials, refer to *Polymer cages*, [page 188](#).

Seals

The permissible operating temperature for PUR seals is -20 to +80 °C (-5 to +175 °F).

Typically, temperature peaks are at the seal lip.

Lubricants

Temperature limits for greases used in sealed double row full complement cylindrical roller bearings are provided in [table 1](#), [page 503](#). For temperature limits of other SKF greases, refer to *Selecting a suitable SKF grease*, [page 116](#).

When using lubricants not supplied by SKF, temperature limits should be evaluated according to the SKF traffic light concept ([page 117](#)).

Permissible speed

The speed ratings in the [product tables](#) indicate:

- the **reference speed**, which enables a quick assessment of the speed capabilities from a thermal frame of reference
- the **limiting speed**, which is a mechanical limit that should not be exceeded unless the bearing design and the application are adapted for higher speeds

For additional information, refer to *Operating temperature and speed*, [page 130](#).

SKF recommends oil lubrication for bearings with a ring centred cage. When these bearings are grease lubricated, the nd_m value is limited:

- for bearings with an LA, LB, LL, MA, MB, ML, MP, JA, JB or MH cage
→ $nd_m \leq 250\,000$ mm/min
- for bearings with a PA or PHA cage
→ $nd_m \leq 450\,000$ mm/min

where

$$d_m = \text{bearing mean diameter [mm]} \\ = 0,5 (d + D)$$

$$n = \text{rotational speed [r/min]}$$

For single row bearings with a standard cage, the values for the limiting speed are listed in the product tables. Conversion factors to estimate the limiting speed for bearings with an alternative standard cage are listed in [table 7](#).

Table 7

Conversion factors for limiting speeds of single row cylindrical roller bearings

Bearing with standard cage	alternative standard cage		
	P, PH, J, M, MR	PA, PHA, MA, MB	ML
P, PH, J, M, MR	1	1,3	1,5
PA, PHA, MA, MB	0,75	1	1,2
ML	0,65	0,85	1

Table 6

Lubrication factors for cylindrical roller bearings

Bearing types	Lubrication factors			
	Oil lubrication		Grease lubrication	
	k_1	k_2	k_1	k_2
Single row and high-capacity bearings	1,5	0,15	1	0,1
Single row full complement bearings	1	0,3	0,5	0,15
Double row full complement bearings	0,35	0,1	0,2	0,06



Design considerations

Flange support

Where cylindrical roller bearings are subjected to axial loads, total axial run-out (*Tolerances for bearing seats and abutments*, page 144) and the size of the abutment surfaces of adjacent components are particularly important for an even load distribution on the flange.

The inner ring flange should only be supported up to half of its height (fig. 24) so that it is not subjected to damaging alternating stresses that can result, for example, from shaft deflection.

For single row bearings and high-capacity bearings the recommended shaft abutment diameter can be obtained using

$$d_{as} = 0,5 (d_1 + F)$$

where

d_{as} = shaft abutment diameter for axially loaded bearings [mm]

d_1 = inner ring flange diameter [mm]
(product tables, page 516)

F = inner ring raceway diameter [mm]
(product tables)

For full complement bearings, the recommended shaft abutment diameter d_{as} is listed in the product tables.

Mounting

Because of the design and position of the cage of high-capacity cylindrical roller bearings in the NCF .. ECJB and NJF .. ECJA series, the cage cannot prevent the rollers from falling out when the inner and outer rings of the bearing are separated. SKF recommends mounting these high-capacity cylindrical roller bearings as a complete bearing, like full complement cylindrical roller bearings.

Where it is necessary to mount the inner and outer rings separately, use a mounting sleeve (fig. 25) or a retaining strap (fig. 26) to keep the rollers in place.

6



Fig. 24

Flange support

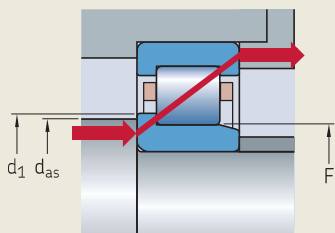

Fig. 25

Mounting sleeve

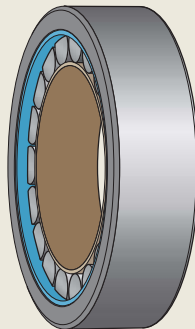
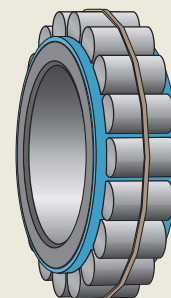

Fig. 26

Retaining strap





Designation system



Prefixes

- L Separate inner or outer ring of a separable bearing
- R Inner or outer ring with roller and cage assembly of a separable bearing

Basic designation

Listed in [table 4, page 30](#)

- CRL Inch bearing
- CRM Inch bearing
- HJ Angle ring

Suffixes

Group 1: Internal design

- A Deviating or modified internal design
- CV Modified internal design, full complement roller set
- EC Optimized internal design incorporating more and/or larger rollers and with modified roller end / flange contact

Group 2: External design (seals, snap ring groove, etc.)

- ADB Modified internal design and seal (for NNF 50 series)
- B Improved seal and grease
- DA Modified internal design and seal (for 3194.. series)
- K Tapered bore, taper 1:12
- N Snap ring groove in the outer ring
- NR Snap ring groove in the outer ring, with associated snap ring
- N1 One locating slot (notch) in one outer ring side face
- N2 Two locating slots (notches) in one outer ring side face, 180° apart
- 2LS Contact seal, PUR, on both sides

Group 3: Cage design

- FR Pin-type steel cage, pierced rollers
- J Stamped steel cage, roller centred
- JA Sheet steel cage, outer ring centred
- JB Sheet steel cage, inner ring centred
- L Machined light alloy cage, roller centred
- LA Machined light alloy cage, outer ring centred
- LB Machined light alloy cage, inner ring centred
- LL Machined light alloy cage, window-type, inner or outer ring centred (depending on bearing design)
- M Machined brass cage, roller centred
- MA(S) Machined brass cage, outer ring centred. The S indicates a lubrication groove in the guiding surface.
- MB Machined brass cage, inner ring centred
- MH Machined brass cage, inner ring raceway centred
- ML Machined brass cage, window-type, inner or outer ring centred (depending on bearing design)
- MP Machined brass cage, window-type, inner or outer ring centred (depending on bearing size)
- MR Machined brass cage, window-type, roller centred
- P Glass fibre reinforced PA66 cage, roller centred
- PA Glass fibre reinforced PA66 cage, outer ring centred
- PH Glass fibre reinforced PEEK cage, roller centred
- PHA Glass fibre reinforced PEEK cage, outer ring centred
- V Full complement of rollers (no cage)
- VH Full complement of rollers (no cage), self-retaining



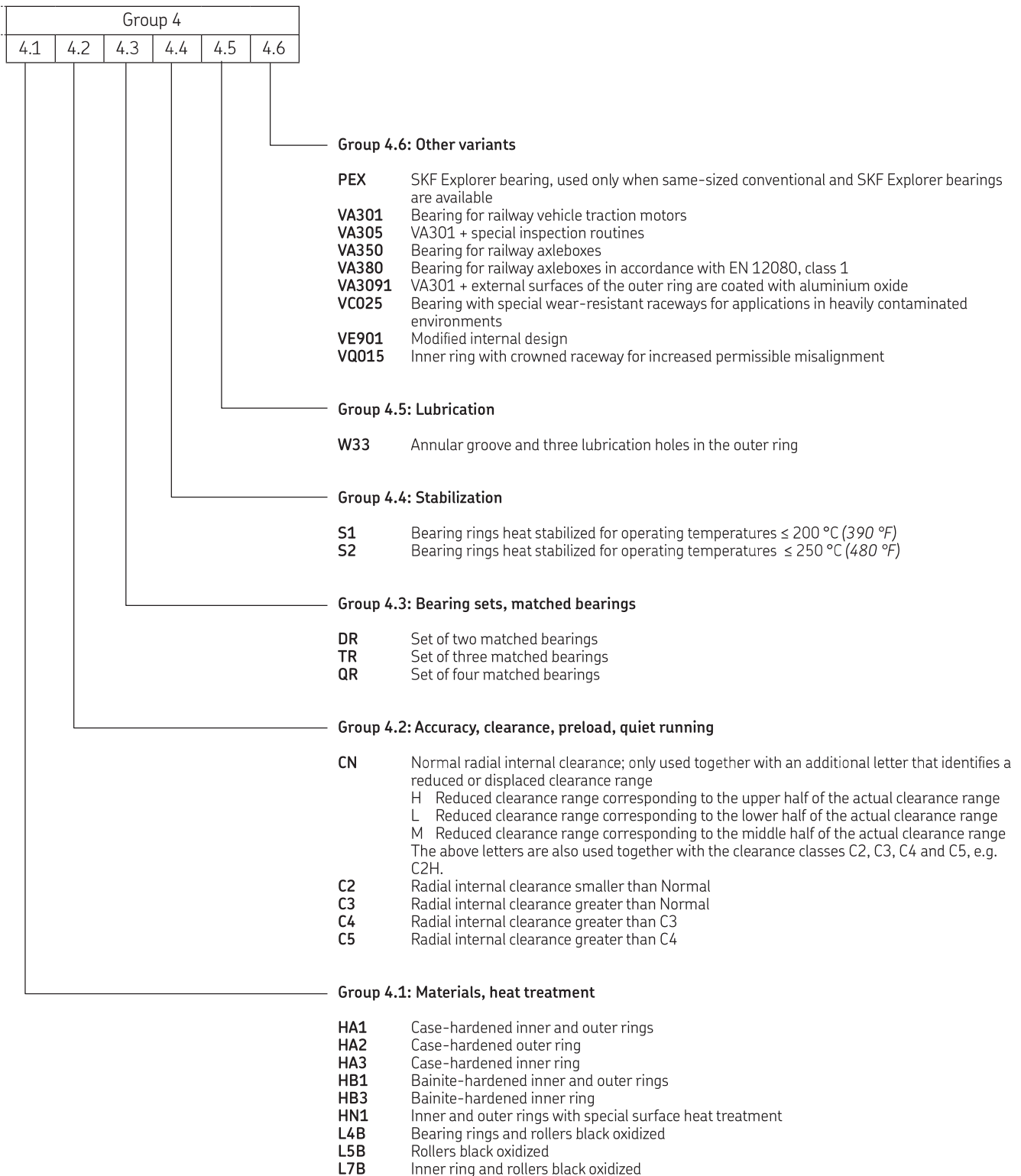

6.1 Single row cylindrical roller bearings

d 15 – 25 mm

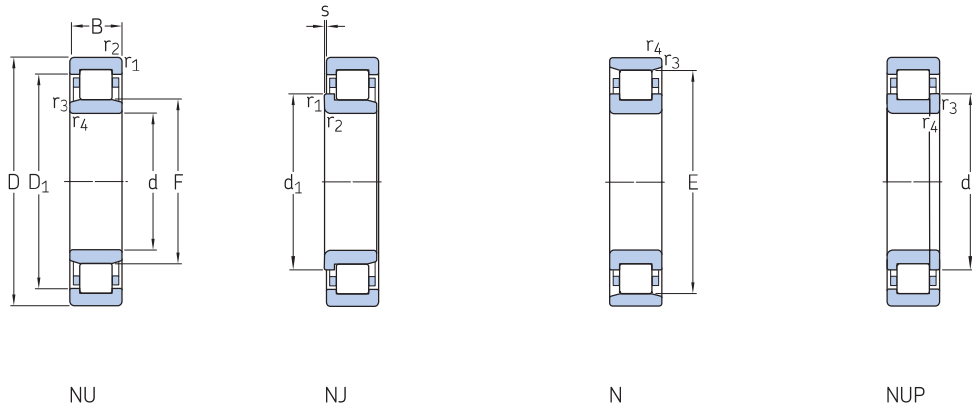

Principal dimensions			Basic load ratings		Fatigue load limit	Speed ratings		Mass	Designations Bearing with standard cage	Alternative standard cage ¹⁾	
d	D	B	C	C ₀		Reference speed	Limiting speed				
mm			kN		kN	r/min		kg	–		
15	35	11	12,5	10,2	1,22	22 000	26 000	0,047	▶ NU 202 ECP	PHA	
	35	11	12,5	10,2	1,22	22 000	26 000	0,048	▶ NJ 202 ECP	PHA	
17	40	12	20	14,3	1,73	20 000	22 000	0,066	▶ N 203 ECP	PH	
	40	12	20	14,3	1,73	20 000	22 000	0,068	▶ NU 203 ECP	PHA	
	40	12	20	14,3	1,73	20 000	22 000	0,069	▶ NJ 203 ECP	PHA	
17	40	12	20	14,3	1,73	20 000	22 000	0,072	▶ NUP 203 ECP	PHA	
	40	16	27,5	21,6	2,65	20 000	22 000	0,087	▶ NU 2203 ECP	–	
	40	16	27,5	21,6	2,65	20 000	22 000	0,093	▶ NJ 2203 ECP	–	
17	40	16	27,5	21,6	2,65	20 000	22 000	0,097	▶ NUP 2203 ECP	–	
	47	14	28,5	20,4	2,55	17 000	20 000	0,12	▶ N 303 ECP	–	
	47	14	28,5	20,4	2,55	17 000	20 000	0,12	▶ NJ 303 ECP	–	
17	47	14	28,5	20,4	2,55	17 000	20 000	0,12	▶ NU 303 ECP	–	
	20	47	14	28,5	22	2,75	17 000	19 000	0,11	▶ N 204 ECP	–
		47	14	28,5	22	2,75	17 000	19 000	0,11	▶ NJ 204 ECP	ML, PHA
47		14	28,5	22	2,75	17 000	19 000	0,11	▶ NU 204 ECP	ML, PHA	
20	47	14	28,5	22	2,75	17 000	19 000	0,12	▶ NUP 204 ECP	ML, PHA	
	47	18	34,5	27,5	3,45	17 000	19 000	0,14	▶ NJ 2204 ECP	–	
	47	18	34,5	27,5	3,45	17 000	19 000	0,14	▶ NU 2204 ECP	–	
20	52	15	35,5	26	3,25	15 000	18 000	0,14	▶ NU 304 ECP	–	
	52	15	35,5	26	3,25	15 000	18 000	0,15	▶ N 304 ECP	–	
	52	15	35,5	26	3,25	15 000	18 000	0,15	▶ NJ 304 ECP	–	
20	52	15	35,5	26	3,25	15 000	18 000	0,16	▶ NUP 304 ECP	–	
	52	21	47,5	38	4,8	15 000	18 000	0,21	▶ NU 2304 ECP	–	
	52	21	47,5	38	4,8	15 000	18 000	0,22	▶ NJ 2304 ECP	–	
20	52	21	47,5	38	4,8	15 000	18 000	0,22	▶ NUP 2304 ECP	–	
	25	47	12	14,2	13,2	1,4	18 000	18 000	0,082	▶ NU 1005	–
		52	15	32,5	27	3,35	15 000	16 000	0,13	▶ N 205 ECP	–
52		15	32,5	27	3,35	15 000	16 000	0,13	▶ NU 205 ECP	J, ML, PH, PHA	
25	52	15	32,5	27	3,35	15 000	16 000	0,14	▶ NJ 205 ECP	J, ML, PH, PHA	
	52	15	32,5	27	3,35	15 000	16 000	0,14	▶ NUP 205 ECP	J, ML, PH, PHA	
	52	18	39	34	4,25	15 000	16 000	0,16	▶ NU 2205 ECP	ML, PH	
25	52	18	39	34	4,25	15 000	16 000	0,17	▶ NJ 2205 ECP	ML, PH	
	52	18	39	34	4,25	15 000	16 000	0,17	▶ NUP 2205 ECP	ML, PH	
	62	17	46,5	36,5	4,55	12 000	15 000	0,23	▶ N 305 ECP	–	

SKF Explorer bearing

▶ Popular item

¹⁾ When ordering bearings with an alternative standard cage the suffix of the standard cage has to be replaced by the suffix of the alternative cage.

For example NU .. ECP becomes NU .. ECML (for permissible speed → [page 511](#)).

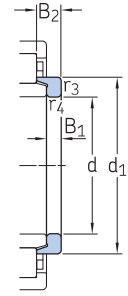
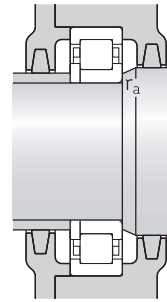
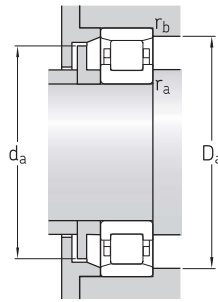
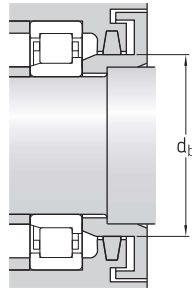
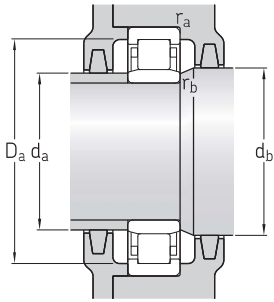

Angle ring

Dimensions				Abutment and fillet dimensions										Calculation factor k_r	Angle ring Designation	Mass	Dimensions	
d	d_1	D_1	F, E	$r_{1,2}$	$r_{3,4}$	s	d_a	d_a	d_b, D_a	D_a	r_a	r_b	k_r				Designation	Mass
mm	mm	mm	mm	mm	mm	mm	mm	mm	mm	mm	mm	mm	mm	mm	mm	mm	mm	
15	-	27,7	19,3	0,6	0,3	1	17,4	18,4	21	31,3	0,6	0,3	0,15	-	-	-	-	
	21,9	27,7	19,3	0,6	0,3	1	18,2	18,4	23	31,3	0,6	-	0,15	-	-	-	-	
17	25	-	35,1	0,6	0,3	1	20,7	33	37	37,1	0,6	0,3	0,12	-	-	-	-	
	-	32,35	22,1	0,6	0,3	1	19,9	21,1	24	36	0,6	0,3	0,15	-	-	-	-	
	25	32,35	22,1	0,6	0,6	1	20,7	21,1	27	36	0,6	-	0,15	-	-	-	-	
	25	32,35	22,1	0,6	0,3	-	20,7	-	27	36	0,6	-	0,15	-	-	-	-	
	-	32,35	22,1	0,6	0,3	1,5	19,9	21,1	24	36	0,6	0,3	0,2	-	-	-	-	
	25	32,35	22,1	0,6	0,3	1,5	20,7	21,1	27	36	0,6	-	0,2	-	-	-	-	
	25	32,35	22,1	0,6	0,3	-	20,7	-	27	36	0,6	-	0,2	-	-	-	-	
	27,7	-	40,2	1	0,6	1	22,1	38	42	42,7	1	0,6	0,12	-	-	-	-	
	27,7	36,75	24,2	1	0,6	1	22,1	23,1	29	41,7	1	-	0,15	-	-	-	-	
	-	36,75	24,2	1	0,6	1	21,1	23,1	26	41,7	1	0,6	0,15	-	-	-	-	
20	29,7	-	41,5	1	0,6	1	25	40	43	43,5	1	0,6	0,12	-	-	-	-	
	29,7	38,44	26,5	1	0,6	1	25	25,4	31	41,7	1	-	0,15	-	-	-	-	
	-	38,44	26,5	1	0,6	1	24	25,4	28	41,7	1	0,6	0,15	-	-	-	-	
	29,7	38,44	26,5	1	0,6	-	25	-	31	41,7	1	-	0,15	-	-	-	-	
	29,7	38,3	26,5	1	0,6	2	25	25,4	31	41,7	1	-	0,2	-	-	-	-	
	-	38,3	26,5	1	0,6	2	24	25,4	28	41,7	1	0,6	0,2	-	-	-	-	
	-	41,85	27,5	1,1	0,6	0,9	24,1	26,2	29	45,4	1	0,6	0,15	HJ 304 EC	0,017	4	6,5	
	31,2	-	45,5	1,1	0,6	0,9	26,1	44	47	48	1	0,6	0,12	-	-	-	-	
	31,2	41,85	27,5	1,1	0,6	0,9	26,1	26,2	33	45,4	1	-	0,15	HJ 304 EC	0,017	4	6,5	
	31,2	41,85	27,5	1,1	0,6	-	26,1	-	33	45,4	1	-	0,15	-	-	-	-	
25	-	38,8	30,5	0,6	0,3	1,5	27,1	29,5	32	43,1	0,6	0,3	0,1	-	-	-	-	
	34,7	-	46,5	1	0,6	1,3	29,9	45	48	48,5	1	0,6	0,12	-	-	-	-	
	-	43,3	31,5	1	0,6	1,3	28,9	30,4	33	46,4	1	0,6	0,15	HJ 205 EC	0,015	3	6	
	34,7	43,3	31,5	1	0,6	1,3	29,9	30,4	36	46,4	1	-	0,15	-	-	-	-	
	34,7	43,3	31,5	1	0,6	-	29,9	-	36	46,4	1	-	0,15	-	-	-	-	
	-	43,3	31,5	1	0,6	1,8	28,9	30,4	33	46,4	1	0,6	0,2	HJ 2205 EC	0,014	3	6,5	
	34,7	43,3	31,5	1	0,6	1,8	29,9	30,4	36	46,4	1	-	0,2	HJ 2205 EC	0,014	3	6,5	
	34,7	43,3	31,5	1	0,6	-	29,9	-	36	46,4	1	-	0,2	-	-	-	-	
	38,1	-	54	1,1	1,1	1,3	31	52	56	56,4	1	1	0,12	-	-	-	-	



6.1 Single row cylindrical roller bearings

d 25 – 35 mm

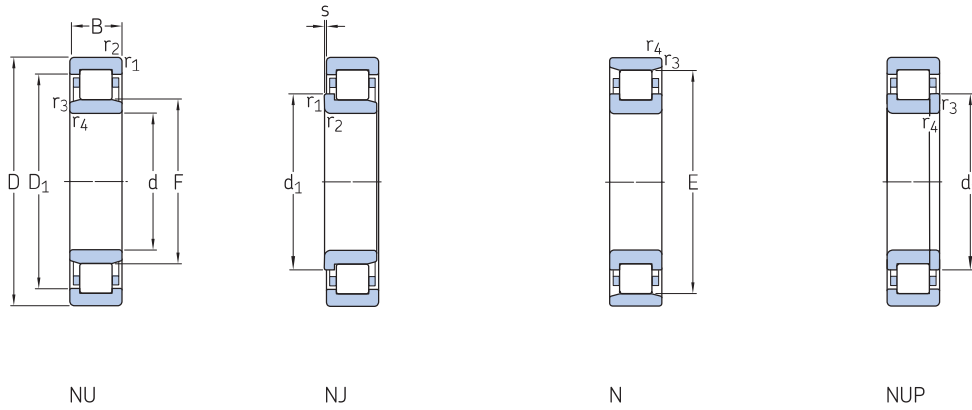

Principal dimensions			Basic load ratings		Fatigue load limit	Speed ratings		Mass	Designations Bearing with standard cage	Alternative standard cage ¹⁾
d	D	B	C	C ₀		Reference speed	Limiting speed			
mm			kN		kN	r/min		kg	–	
25 cont.	62	17	46,5	36,5	4,55	12 000	15 000	0,23	▶ NU 305 ECP	J, ML
	62	17	46,5	36,5	4,55	12 000	15 000	0,24	▶ NJ 305 ECP	J, ML
	62	17	46,5	36,5	4,55	12 000	15 000	0,25	▶ NUP 305 ECP	J, ML
	62	24	64	55	6,95	12 000	15 000	0,34	▶ NU 2305 ECP	J, ML
	62	24	64	55	6,95	12 000	15 000	0,35	▶ NJ 2305 ECP	J, ML
	62	24	64	55	6,95	12 000	15 000	0,36	▶ NUP 2305 ECP	J, ML
30	55	13	17,9	17,3	1,86	15 000	15 000	0,11	▶ NU 1006	–
	62	16	44	36,5	4,5	13 000	14 000	0,2	▶ N 206 ECP	–
	62	16	44	36,5	4,5	13 000	14 000	0,2	▶ NU 206 ECP	J, ML, PH
	62	16	44	36,5	4,55	13 000	14 000	0,21	▶ NJ 206 ECP	J, ML, PH
	62	16	44	36,5	4,55	13 000	14 000	0,21	▶ NUP 206 ECP	J, ML, PH
	62	20	55	49	6,1	13 000	14 000	0,26	▶ NJ 2206 ECP	J, ML, PH
	62	20	55	49	6,1	13 000	14 000	0,26	▶ NU 2206 ECP	J, ML, PH
	62	20	55	49	6,1	13 000	14 000	0,27	▶ NUP 2206 ECP	J, ML, PH
	72	19	58,5	48	6,2	11 000	12 000	0,36	▶ N 306 ECP	–
	72	19	58,5	48	6,2	11 000	12 000	0,36	▶ NU 306 ECP	J, M, ML
	72	19	58,5	48	6,2	11 000	12 000	0,37	▶ NJ 306 ECP	J, M, ML
	72	19	58,5	48	6,2	11 000	12 000	0,38	▶ NUP 306 ECP	J, M, ML
	72	27	83	75	9,65	11 000	12 000	0,53	▶ NU 2306 ECP	ML, PH
	72	27	83	75	9,65	11 000	12 000	0,54	▶ NJ 2306 ECP	ML, PH
	72	27	83	75	9,65	11 000	12 000	0,54	▶ NUP 2306 ECP	ML, PH
	90	23	60,5	53	6,8	9 000	11 000	0,75	▶ NU 406	MA
	90	23	60,5	53	6,8	9 000	11 000	0,78	▶ NJ 406	MA
	35	62	14	35,8	38	4,55	13 000	13 000	0,16	▶ NU 1007 ECP
72		17	56	48	6,1	11 000	12 000	0,29	▶ NU 207 ECP	J, M, ML, PH, PHA
72		17	56	48	6,1	11 000	12 000	0,3	▶ N 207 ECP	–
72		17	56	48	6,1	11 000	12 000	0,3	▶ NJ 207 ECP	J, M, ML, PH, PHA
72		17	56	48	6,1	11 000	12 000	0,31	▶ NUP 207 ECP	J, M, ML, PH, PHA
72		23	69,5	63	8,15	11 000	12 000	0,4	▶ NU 2207 ECP	J, ML, PH
72		23	69,5	63	8,15	11 000	12 000	0,41	▶ NJ 2207 ECP	J, ML, PH
72		23	69,5	63	8,15	11 000	12 000	0,42	▶ NUP 2207 ECP	J, ML, PH
80		21	75	63	8,15	9 500	11 000	0,47	▶ NU 307 ECP	J, M, ML, PH
80		21	75	63	8,15	9 500	11 000	0,48	▶ N 307 ECP	–
80		21	75	63	8,15	9 500	11 000	0,49	▶ NJ 307 ECP	J, M, ML, PH
80		21	75	63	8,15	9 500	11 000	0,49	▶ NUP 307 ECP	J, M, ML, PH

SKF Explorer bearing

▶ Popular item

¹⁾ When ordering bearings with an alternative standard cage the suffix of the standard cage has to be replaced by the suffix of the alternative cage.

For example NU .. ECP becomes NU .. ECML (for permissible speed → [page 511](#)).

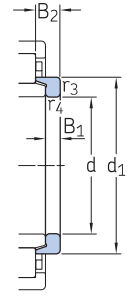
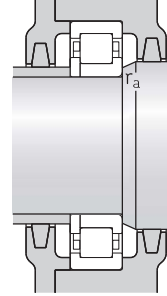
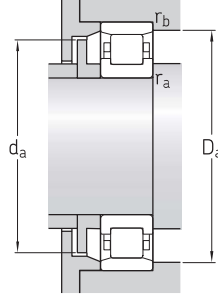
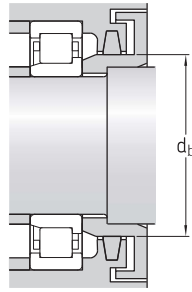
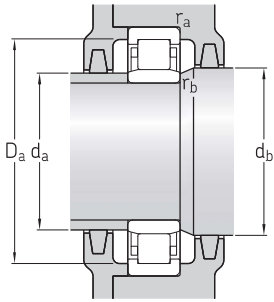

Angle ring

Dimensions				Abutment and fillet dimensions										Calculation factor k_r	Angle ring Designation	Mass	Dimensions	
d	d_1	D_1	F, E	$r_{1,2}$	$r_{3,4}$	s	d_a	d_a	d_b, D_a	D_a	r_a	r_b	B_1				B_2	
mm	mm	mm	mm	mm	mm	mm	mm	mm	mm	mm	mm	mm	mm	mm	mm	mm	mm	
25 cont.	–	50,15	34	1,1	1,1	1,3	31	32,5	36	54,9	1	1	0,15	HJ 305 EC	0,025	4	7	
	38,1	50,15	34	1,1	1,1	1,3	31	32,5	40	54,9	1	–	0,15	HJ 305 EC	0,025	4	7	
	38,1	50,15	34	1,1	1,1	–	31	–	40	54,9	1	–	0,15	–	–	–	–	
	–	50,15	34	1,1	1,1	2,3	31	32,5	36	54,9	1	1	0,25	HJ 2305 EC	0,023	4	8	
	38,1	50,15	34	1,1	1,1	2,3	31	32,5	40	54,9	1	–	0,25	HJ 2305 EC	0,023	4	8	
	38,1	50,15	34	1,1	1,1	–	31	–	40	54,9	1	–	0,25	–	–	–	–	
30	–	45,56	36,5	1	0,6	1,6	32,9	35,6	38	49,8	1	0,6	0,1	–	–	–	–	
	41,2	–	55,5	1	0,6	1,3	35,3	54	57	58,1	1	0,6	0,12	–	–	–	–	
	–	51,95	37,5	1	0,6	1,3	34,3	36,1	39	55,9	1	0,6	0,15	HJ 206 EC	0,025	4	7	
	41,2	51,95	37,5	1	0,6	1,3	35,3	36,1	43	55,9	1	–	0,15	HJ 206 EC	0,025	4	7	
	41,2	51,95	37,5	1	0,6	–	35,3	–	43	55,9	1	–	0,15	–	–	–	–	
	41,2	51,95	37,5	1	0,6	1,8	35,3	36,1	43	55,9	1	–	0,2	–	–	–	–	
	–	51,95	37,5	1	0,6	1,8	34,3	36,1	39	55,9	1	0,6	0,2	–	–	–	–	
	41,2	51,95	37,5	1	0,6	–	35,3	–	43	55,9	1	–	0,2	–	–	–	–	
	45	–	62,5	1,1	1,1	1,4	37	61	64	65,5	1	1	0,12	–	–	–	–	
	–	58,35	40,5	1,1	1,1	1,4	37	39	43	65,1	1	1	0,15	HJ 306 EC	0,042	5	8,5	
	45	58,35	40,5	1,1	1,1	1,4	37	39	47	65,1	1	–	0,15	HJ 306 EC	0,042	5	8,5	
	45	58,35	40,5	1,1	1,1	–	37	–	47	65,1	1	–	0,15	–	–	–	–	
–	58,35	40,5	1,1	1,1	2,4	37	39	43	65,1	1	1	0,25	–	–	–	–		
45	58,35	40,5	1,1	1,1	2,4	37	39	47	65,1	1	–	0,25	–	–	–	–		
45	58,35	40,5	1,1	1,1	–	37	–	47	65,1	1	–	0,25	–	–	–	–		
–	66,1	45	1,5	1,5	1,6	41	43	47	81	1,5	1,5	0,15	HJ 406	0,08	7	11,5		
50,5	66,1	45	1,5	1,5	1,6	41	43	53	81	1,5	–	0,15	HJ 406	0,08	7	11,5		
35	–	53,95	42	1	0,6	1	38	41	44	56,5	1	0,6	0,1	–	–	–	–	
	–	60,2	44	1,1	0,6	1,3	39,8	42,2	46	65,1	1	0,6	0,15	HJ 207 EC	0,033	4	7	
	48,1	–	64	1,1	0,6	1,3	41,8	62	66	67,2	1	0,6	0,12	–	–	–	–	
	48,1	60,2	44	1,1	0,6	1,3	41,8	42,2	50	65,1	1	–	0,15	HJ 207 EC	0,033	4	7	
	48,1	60,2	44	1,1	0,6	–	41,8	–	50	65,1	1	–	0,15	–	–	–	–	
	–	60,2	44	1,1	0,6	2,8	39,8	42,2	46	65,1	1	0,6	0,2	–	–	–	–	
	48,1	60,2	44	1,1	0,6	2,8	41,8	42,2	50	65,1	1	–	0,2	–	–	–	–	
	48,1	60,2	44	1,1	0,6	–	42	–	50	65,1	1	–	0,2	–	–	–	–	
	–	65,8	46,2	1,5	1,1	1,2	42	44	48	72,2	1,5	1	0,15	HJ 307 EC	0,058	6	9,5	
	51	–	70,2	1,5	1,1	1,2	43	68	72	73,4	1,5	1	0,12	–	–	–	–	
	51	65,8	46,2	1,5	1,1	1,2	43	44	53	72,2	1,5	–	0,15	HJ 307 EC	0,058	6	9,5	
	51	65,8	46,2	1,5	1,1	–	44	–	53	72,2	1,5	–	0,15	–	–	–	–	



6.1 Single row cylindrical roller bearings

d 35 – 45 mm

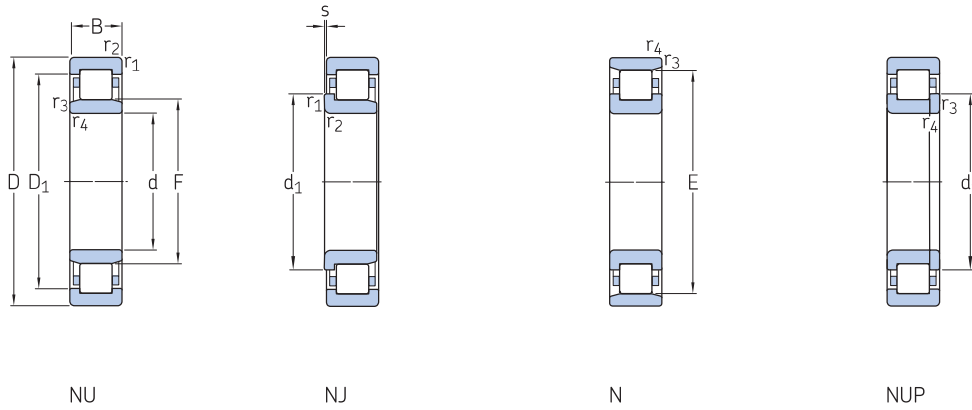

6.1

Principal dimensions			Basic load ratings		Fatigue load limit	Speed ratings		Mass	Designations Bearing with standard cage	Alternative standard cage ¹⁾
d	D	B	C	C ₀		Reference speed	Limiting speed			
mm			kN		kN	r/min		kg	–	
35 cont.	80	31	106	98	12,7	9 500	11 000	0,72	▶ NU 2307 ECP	PH
	80	31	106	98	12,7	9 500	11 000	0,73	▶ NJ 2307 ECP	PH
	80	31	106	98	12,7	9 500	11 000	0,76	▶ NUP 2307 ECP	PH
	100	25	76,5	69,5	9	8 000	9 500	1	▶ NJ 407	–
	100	25	76,5	69,5	9	8 000	9 500	1	▶ NU 407	–
40	68	15	25,1	26	3	12 000	18 000	0,23	▶ NU 1008 ML	–
	80	18	62	53	6,7	9 500	11 000	0,37	▶ N 208 ECP	PH
	80	18	62	53	6,7	9 500	11 000	0,37	▶ NU 208 ECP	J, M, ML, PH
	80	18	62	53	6,7	9 500	11 000	0,38	▶ NJ 208 ECP	J, M, ML, PH
	80	18	62	53	6,7	9 500	11 000	0,39	▶ NUP 208 ECP	J, M, ML, PH
	80	23	81,5	75	9,65	9 500	11 000	0,49	▶ NU 2208 ECP	J, ML, PH
	80	23	81,5	75	9,65	9 500	11 000	0,51	▶ NJ 2208 ECP	J, ML, PH
	80	23	81,5	75	9,65	9 500	11 000	0,51	▶ NUP 2208 ECP	J, ML, PH
	90	23	93	78	10,2	8 000	9 500	0,65	▶ N 308 ECP	M
	90	23	93	78	10,2	8 000	9 500	0,65	▶ NU 308 ECP	J, M, ML, PH
	90	23	93	78	10,2	8 000	9 500	0,67	▶ NJ 308 ECP	J, M, ML, PH
	90	23	93	78	10,2	8 000	9 500	0,68	▶ NUP 308 ECP	J, M, ML, PH
	90	33	129	120	15,3	8 000	9 500	0,93	▶ NU 2308 ECP	J, M, ML, PH
	90	33	129	120	15,3	8 000	9 500	0,95	▶ NJ 2308 ECP	J, M, ML, PH
	90	33	129	120	15,3	8 000	9 500	0,98	▶ NUP 2308 ECP	J, M, ML, PH
	110	27	96,8	90	11,6	7 000	8 500	1,3	▶ NJ 408	M, MA
110	27	96,8	90	11,6	7 000	8 500	1,3	▶ NU 408	M, MA	
45	75	16	44,6	52	6,3	11 000	11 000	0,25	▶ NU 1009 ECP	–
	75	16	44,6	52	6,3	11 000	11 000	0,26	▶ NJ 1009 ECP	PH
	85	19	69,5	64	8,15	9 000	9 500	0,42	▶ NU 209 ECP	J, M, ML
	85	19	69,5	64	8,15	9 000	9 500	0,43	▶ N 209 ECP	M
	85	19	69,5	64	8,15	9 000	9 500	0,44	▶ NJ 209 ECP	J, M, ML
	85	19	69,5	64	8,15	9 000	9 500	0,44	▶ NUP 209 ECP	J, M, ML
	85	23	85	81,5	10,6	9 000	9 500	0,52	▶ NU 2209 ECP	J, PH
	85	23	85	81,5	10,6	9 000	9 500	0,54	▶ NJ 2209 ECP	J, PH
	85	23	85	81,5	10,6	9 000	9 500	0,55	▶ NUP 2209 ECP	J, PH
	100	25	112	100	12,9	7 500	8 500	0,88	▶ N 309 ECP	–
	100	25	112	100	12,9	7 500	8 500	0,89	▶ NJ 309 ECP	J, M, ML, PH
	100	25	112	100	12,9	7 500	8 500	0,9	▶ NU 309 ECP	J, M, ML, PH

SKF Explorer bearing

▶ Popular item

¹⁾ When ordering bearings with an alternative standard cage the suffix of the standard cage has to be replaced by the suffix of the alternative cage.

For example NU .. ECP becomes NU .. ECML (for permissible speed → page 511).

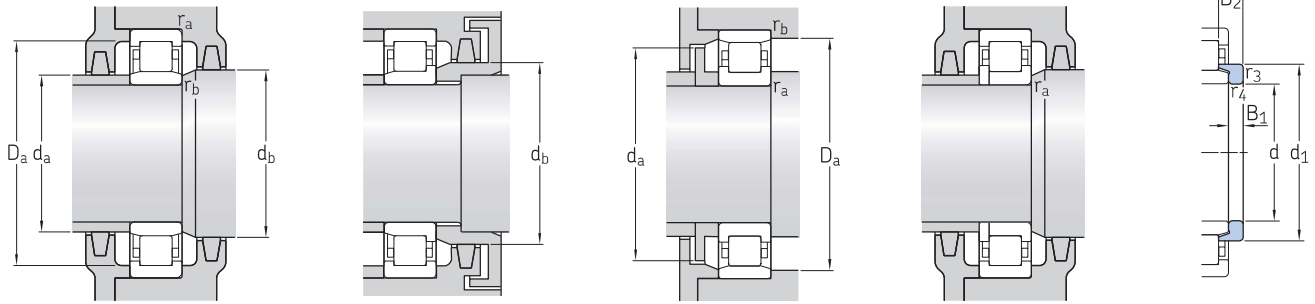

Angle ring

Dimensions							Abutment and fillet dimensions						Calculation factor k_r	Angle ring Designation	Mass	Dimensions	
d	d_1	D_1	F, E	$r_{1,2}$	$r_{3,4}$	s	d_a	d_a	d_b, D_a	D_a	r_a	r_b				B_1	B_2
mm							mm						-	-	kg	mm	
35	-	65,8	46,2	1,5	1,1	2,7	42	44	48	72,2	1,5	1	0,25	-	-	-	-
	cont.	51	65,8	46,2	1,5	1,1	2,7	43	44	53	72,2	1,5	-	0,25	-	-	-
		51	65,8	46,2	1,5	1,1	-	43	-	53	72,2	1,5	-	0,25	-	-	-
	59	77,15	53	1,5	1,5	1,7	48	51	61	90	1,5	-	0,15	-	-	-	-
	-	77,15	53	1,5	1,5	1,7	48	51	55	90	1,5	1,5	0,15	-	-	-	-
40	-	57,6	47	1	0,6	2,4	43	46	49	62,3	1	0,6	0,15	-	-	-	-
	54	-	71,5	1,1	1,1	1,4	47	69	73	74,1	1	1	0,12	-	-	-	-
	-	67,4	49,5	1,1	1,1	1,4	47	48	51	72,8	1	1	0,15	HJ 208 EC	0,047	5	8,5
	54	67,4	49,5	1,1	1,1	1,4	47	48	56	72,8	1	-	0,15	HJ 208 EC	0,047	5	8,5
	54	67,4	49,5	1,1	1,1	-	47	-	56	72,8	1	-	0,15	-	-	-	-
	-	67,4	49,5	1,1	1,1	1,9	47	48	51	72,8	1	1	0,2	HJ 2208 EC	0,048	5	9
	54	67,4	49,5	1,1	1,1	1,9	47	48	56	72,8	1	-	0,2	HJ 2208 EC	0,048	5	9
	54	67,4	49,5	1,1	1,1	-	47	-	56	72,8	1	-	0,2	-	-	-	-
	57,5	-	80	1,5	1,5	1,4	48	78	82	83,2	1,5	1,5	0,12	-	-	-	-
	-	75	52	1,5	1,5	1,4	48	50	54	81,8	1,5	1,5	0,15	HJ 308 EC	0,084	7	11
57,5	75	52	1,5	1,5	1,4	48	50	60	81,8	1,5	-	0,15	HJ 308 EC	0,084	7	11	
57,5	75	52	1,5	1,5	-	48	-	60	81,8	1,5	-	0,15	-	-	-	-	
-	75	52	1,5	1,5	2,9	48	50	54	81,8	1,5	1,5	0,25	-	-	-	-	
57,5	75	52	1,5	1,5	2,9	48	50	60	81,8	1,5	-	0,25	-	-	-	-	
57,5	75	52	1,5	1,5	-	48	-	60	81,8	1,5	-	0,25	-	-	-	-	
64,8	85,3	58	2	2	2,5	52	56	67	99	2	-	0,15	-	-	-	-	
-	85,3	58	2	2	2,5	52	56	60	99	2	2	0,15	-	-	-	-	
45	-	65,3	52,5	1	0,6	0,9	48,4	51	54	69,8	1	0,6	0,1	-	-	-	-
	56	65,3	52,5	1	0,6	0,9	48,4	51	57,5	69,8	1	-	0,1	-	-	-	-
	-	72,4	54,5	1,1	1,1	1,2	52	53	56	77,6	1	1	0,15	HJ 209 EC	0,052	5	8,5
	59	-	76,5	1,1	1,1	1,2	52	74	78	79,1	1	1	0,12	-	-	-	-
	59	72,4	54,5	1,1	1,1	1,2	52	53	61	77,6	1	-	0,15	HJ 209 EC	0,052	5	8,5
	59	72,4	54,5	1,1	1,1	-	52	-	61	77,6	1	-	0,15	-	-	-	-
	-	72,4	54,5	1,1	1,1	1,7	52	53	56	77,6	1	1	0,2	-	-	-	-
	59	72,4	54,5	1,1	1,1	1,7	52	53	61	77,6	1	-	0,2	-	-	-	-
	59	72,4	54,5	1,1	1,1	-	52	-	61	77,6	1	-	0,2	-	-	-	-
	64,4	-	88,5	1,5	1,5	1,7	54	86	91	92,3	1,5	1,5	0,12	-	-	-	-
64,4	83,2	58,5	1,5	1,5	1,7	54	56	67	91,4	1,5	-	0,15	HJ 309 EC	0,11	7	11,5	
-	83,2	58,5	1,5	1,5	1,7	54	56	60	91,4	1,5	1,5	0,15	HJ 309 EC	0,11	7	11,5	



6.1 Single row cylindrical roller bearings

d 45 – 55 mm

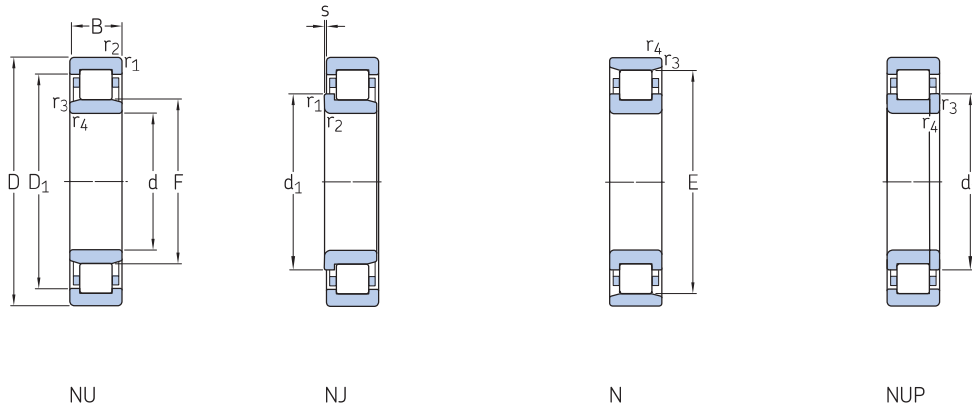

Principal dimensions			Basic load ratings		Fatigue load limit	Speed ratings		Mass	Designations Bearing with standard cage	Alternative standard cage ¹⁾
d	D	B	C	C ₀		Reference speed	Limiting speed			
mm			kN		kN	r/min		kg	–	
45 cont.	100	25	112	100	12,9	7 500	8 500	0,93	▶ NUP 309 ECP	J, M, ML, PH
	100	36	160	153	20	7 500	8 500	1,3	▶ NU 2309 ECP	ML
	100	36	160	153	20	7 500	8 500	1,35	▶ NJ 2309 ECP	ML
	120	29	106	102	13,4	6 700	7 500	1,65	▶ NUP 2309 ECP	ML
	120	29	106	102	13,4	6 700	7 500	1,65	▶ NJ 409	–
									▶ NU 409	–
50	80	16	46,8	56	6,7	9 500	9 500	0,27	▶ NU 1010 ECP	–
	90	20	73,5	69,5	8,8	8 500	9 000	0,47	▶ NU 210 ECP	J, M, ML, PH
	90	20	73,5	69,5	8,8	8 500	9 000	0,48	▶ N 210 ECP	M
	90	20	73,5	69,5	8,8	8 500	9 000	0,49	▶ NJ 210 ECP	J, M, ML, PH
	90	20	73,5	69,5	8,8	8 500	9 000	0,5	▶ NUP 210 ECP	J, M, ML, PH
	90	23	90	88	11,4	8 500	9 000	0,56	▶ NU 2210 ECP	J, M, ML, PH
	90	23	90	88	11,4	8 500	9 000	0,57	▶ NJ 2210 ECP	J, M, ML, PH
	90	23	90	88	11,4	8 500	9 000	0,59	▶ NUP 2210 ECP	J, M, ML, PH
	110	27	127	112	15	6 700	8 000	1,1	▶ N 310 ECP	–
	110	27	127	112	15	6 700	8 000	1,1	▶ NU 310 ECP	J, M, ML, PH
	110	27	127	112	15	6 700	8 000	1,15	▶ NJ 310 ECP	J, M, ML, PH
	110	27	127	112	15	6 700	8 000	1,15	▶ NUP 310 ECP	J, M, ML, PH
	110	40	186	186	24,5	6 700	8 000	1,75	▶ NJ 2310 ECP	ML, PH
	110	40	186	186	24,5	6 700	8 000	1,75	▶ NU 2310 ECP	ML, PH
	110	40	186	186	24,5	6 700	8 000	1,75	▶ NUP 2310 ECP	ML, PH
130	31	130	127	16,6	6 000	7 000	2	▶ NU 410	–	
	31	130	127	16,6	6 000	7 000	2,05	▶ NJ 410	–	
55	90	18	57,2	69,5	8,3	8 500	8 500	0,39	▶ NU 1011 ECP	ML
	90	18	57,2	69,5	8,3	8 500	8 500	0,42	▶ NJ 1011 ECP	ML
	100	21	96,5	95	12,2	7 500	8 000	0,65	▶ N 211 ECP	–
	100	21	96,5	95	12,2	7 500	8 000	0,66	▶ NU 211 ECP	J, M, ML
	100	21	96,5	95	12,2	7 500	8 000	0,67	▶ NJ 211 ECP	J, M, ML
	100	21	96,5	95	12,2	7 500	8 000	0,68	▶ NUP 211 ECP	J, M, ML
	100	25	114	118	15,3	7 500	8 000	0,79	▶ NU 2211 ECP	J, M, ML, PH
	100	25	114	118	15,3	7 500	8 000	0,81	▶ NJ 2211 ECP	J, M, ML, PH
	100	25	114	118	15,3	7 500	8 000	0,82	▶ NUP 2211 ECP	J, M, ML, PH
	120	29	156	143	18,6	6 000	7 000	1,45	▶ N 311 ECP	M
	120	29	156	143	18,6	6 000	7 000	1,45	▶ NU 311 ECP	J, M, ML
	120	29	156	143	18,6	6 000	7 000	1,5	▶ NJ 311 ECP	J, M, ML

SKF Explorer bearing

▶ Popular item

¹⁾ When ordering bearings with an alternative standard cage the suffix of the standard cage has to be replaced by the suffix of the alternative cage.

For example NU .. ECP becomes NU .. ECML (for permissible speed → page 511).

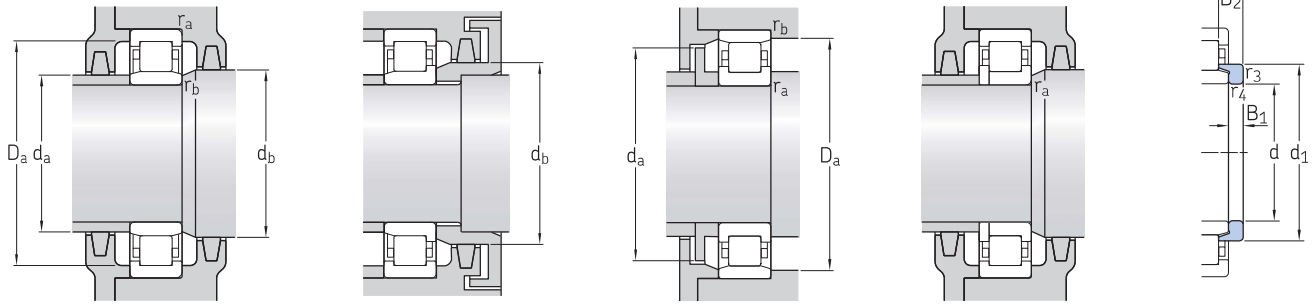

Angle ring

Dimensions			Abutment and fillet dimensions											Calculation factor k_r	Angle ring Designation	Mass	Dimensions	
d	d_1	D_1	F, E	$r_{1,2}$	$r_{3,4}$	s	d_a	d_a	d_b, D_a	D_a	r_a	r_b	B_1				B_2	
mm	\approx	\approx		min.	min.	max.	min.	max.	min.	max.	max.	max.			kg	mm		
45	64,4	83,2	58,5	1,5	1,5	–	54	–	67	91,4	1,5	–	0,15	–	–	–	–	
	–	83,2	58,5	1,5	1,5	3,2	54	56	60	91,4	1,5	1,5	0,25	–	–	–	–	
	64,4	83,2	58,5	1,5	1,5	3,2	54	56	67	91,4	1,5	–	0,25	–	–	–	–	
50	64,4	83,2	58,5	1,5	1,5	–	54	–	67	91,4	1,5	–	0,25	–	–	–	–	
	71,8	93,4	64,5	2	2	2,5	58	62	75	108	2	–	0,15	HJ 409	0,18	8	13,5	
	–	93,4	64,5	2	2	2,5	58	62	66	108	2	2	0,15	HJ 409	0,18	8	13,5	
	–	70,5	57,5	1	0,6	1	57	56	59	74,6	1	0,6	0,1	–	–	–	–	
	–	77,4	59,5	1,1	1,1	1,5	57	57,5	61	82,4	1	1	0,15	HJ 210 EC	0,058	5	9	
	64	–	81,5	1,1	1,1	1,5	57	79	83	84	1	1	0,12	–	–	–	–	
	64	77,4	59,5	1,1	1,1	1,5	57	57,5	66	82,4	1	–	0,15	–	–	–	–	
	64	77,4	59,5	1,1	1,1	–	57	–	66	82,4	1	–	0,15	–	–	–	–	
	–	77,4	59,5	1,1	1,1	1,5	57	57,5	61	82,4	1	1	0,2	–	–	–	–	
	64	77,4	59,5	1,1	1,1	1,5	57	57,5	66	82,4	1	–	0,2	–	–	–	–	
	64	77,4	59,5	1,1	1,1	–	57	–	66	82,4	1	–	0,2	–	–	–	–	
	71,2	–	97	2	2	1,9	60	95	99	101	2	2	0,12	–	–	–	–	
–	91,4	65	2	2	1,9	60	63	67	99,6	2	2	0,15	HJ 310 EC	0,15	8	13		
71,2	91,4	65	2	2	1,9	60	63	73	99,6	2	–	0,15	HJ 310 EC	0,15	8	13		
71,2	91,4	65	2	2	–	60	–	73	99,6	2	–	0,15	–	–	–	–		
71,2	91,4	65	2	2	3,4	60	63	73	99,6	2	–	0,25	–	–	–	–		
–	91,4	65	2	2	3,4	60	63	67	99,6	2	2	0,25	–	–	–	–		
71,2	91,4	65	2	2	–	60	–	73	99,6	2	–	0,25	–	–	–	–		
–	101,6	70,8	2,1	2,1	2,6	64	68	73	116	2	2	0,15	HJ 410	0,15	9	14,5		
78,8	101,6	70,8	2,1	2,1	2,6	64	68	81	116	2	–	0,15	HJ 410	0,15	9	14,5		
55	–	79	64,5	1,1	1	0,5	59,7	63	66	83	1	1	0,1	–	–	–	–	
	68	79	64,5	1,1	1	0,5	60	63	70	83	2	–	0,1	–	–	–	–	
	70,8	–	90	1,5	1,1	1	63	88	92	93	1,5	1	0,12	–	–	–	–	
	–	85,6	66	1,5	1,1	1	62	64	68	91,4	1,5	1	0,15	HJ 211 EC	0,083	6	9,5	
	70,8	85,6	66	1,5	1,1	1	63	64	73	91,4	1,5	–	0,15	HJ 211 EC	0,083	6	9,5	
	70,8	85,6	66	1,5	1,1	–	63	–	73	91,4	1,5	–	0,15	–	–	–	–	
	–	85,6	66	1,5	1,1	1,5	62	64	68	91,4	1,5	1	0,2	HJ 2211 EC	0,085	6	10	
	70,8	85,6	66	1,5	1,1	1,5	63	64	73	91,4	1	–	0,2	HJ 2211 EC	0,085	6	10	
	70,8	85,6	66	1,5	1,1	–	63	–	73	91,4	1,5	–	0,2	–	–	–	–	
	77,5	–	106,5	2	2	2	65	104	109	111	2	2	0,12	–	–	–	–	
	–	100,3	70,5	2	2	2	65	68	73	109,2	2	2	0,15	HJ 311 EC	0,19	9	14	
	77,5	100,3	70,5	2	2	2	65	68	80	109,2	2	–	0,15	HJ 311 EC	0,19	9	14	



6.1 Single row cylindrical roller bearings

d 55 – 65 mm

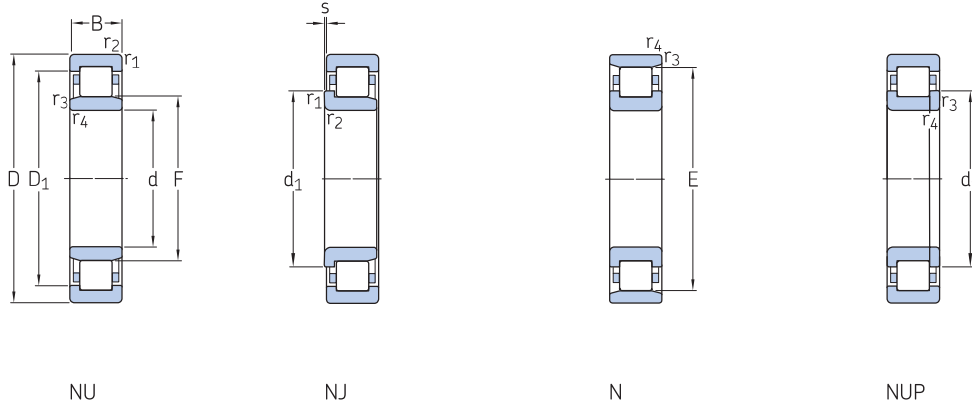

6.1

Principal dimensions			Basic load ratings		Fatigue load limit	Speed ratings		Mass	Designations Bearing with standard cage	Alternative standard cage ¹⁾
d	D	B	C	C ₀		Reference speed	Limiting speed			
mm			kN		kN	r/min		kg	–	
55 cont.	120	29	156	143	18,6	6 000	7 000	1,5	▶ NUP 311 ECP	J, M, ML
	120	43	232	232	30,5	6 000	7 000	2,25	▶ NJ 2311 ECP	ML, PH
	120	43	232	232	30,5	6 000	7 000	2,25	▶ NU 2311 ECP	ML, PH
	120	43	232	232	30,5	6 000	7 000	2,3	▶ NUP 2311 ECP	ML, PH
	140	33	142	140	18,6	5 600	6 300	2,5	▶ NU 411	–
	140	33	142	140	18,6	5 600	6 300	2,55	▶ NJ 411	–
60	95	18	37,4	44	5,3	8 000	13 000	0,5	▶ NU 1012 ML	–
	110	22	108	102	13,4	6 700	7 500	0,79	▶ N 212 ECP	M
	110	22	108	102	13,4	6 700	7 500	0,8	▶ NU 212 ECP	J, M, ML
	110	22	108	102	13,4	6 700	7 500	0,82	▶ NJ 212 ECP	J, M, ML
	110	22	108	102	13,4	6 700	7 500	0,86	▶ NUP 212 ECP	J, M, ML
	110	28	146	153	20	6 700	7 500	1,05	▶ NU 2212 ECP	J, M, ML, PH
	110	28	146	153	20	6 700	7 500	1,1	▶ NJ 2212 ECP	J, M, ML, PH
	110	28	146	153	20	6 700	7 500	1,1	▶ NUP 2212 ECP	J, M, ML, PH
	130	31	173	160	21,2	5 600	6 700	1,75	▶ N 312 ECP	J, M
	130	31	173	160	21,2	5 600	6 700	1,75	▶ NU 312 ECP	J, M, ML, PH
	130	31	173	160	21,2	5 600	6 700	1,85	▶ NJ 312 ECP	J, M, ML, PH
	130	31	173	160	21,2	5 600	6 700	1,9	▶ NUP 312 ECP	J, M, ML, PH
	130	46	260	265	34,5	5 600	6 700	2,75	▶ NU 2312 ECP	M, ML, PH
	130	46	260	265	34,5	5 600	6 700	2,8	▶ NJ 2312 ECP	M, ML, PH
	130	46	260	265	34,5	5 600	6 700	2,85	▶ NUP 2312 ECP	M, ML, PH
150	35	168	173	22	5 000	6 000	3	▶ NU 412	–	
150	35	168	173	22	5 000	6 000	3,05	▶ NJ 412	–	
65	100	18	38	46,5	5,5	7 500	12 000	0,51	▶ NU 1013 ML	–
	100	18	62,7	81,5	9,8	7 500	7 500	0,45	▶ NU 1013 ECP	PH
	120	23	122	118	15,6	6 300	6 700	1	▶ NU 213 ECP	J, M, ML, PH
	120	23	122	118	15,6	6 300	6 700	1,05	▶ N 213 ECP	–
	120	23	122	118	15,6	6 300	6 700	1,05	▶ NJ 213 ECP	J, M, ML, PH
	120	23	122	118	15,6	6 300	6 700	1,05	▶ NUP 213 ECP	J, M, ML, PH
	120	31	170	180	24	6 300	6 700	1,4	▶ NU 2213 ECP	J, ML, PH
	120	31	170	180	24	6 300	6 700	1,45	▶ NJ 2213 ECP	J, ML, PH
	120	31	170	180	24	6 300	6 700	1,45	▶ NUP 2213 ECP	J, ML, PH
	140	33	212	196	25,5	5 300	6 000	2,2	▶ N 313 ECP	M
	140	33	212	196	25,5	5 300	6 000	2,2	▶ NU 313 ECP	J, M, ML, PH
	140	33	212	196	25,5	5 300	6 000	2,3	▶ NJ 313 ECP	J, M, ML, PH

SKF Explorer bearing

▶ Popular item

¹⁾ When ordering bearings with an alternative standard cage the suffix of the standard cage has to be replaced by the suffix of the alternative cage.

For example NU .. ECP becomes NU .. ECML (for permissible speed → [page 511](#)).

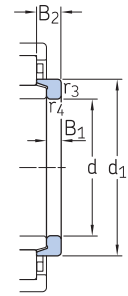
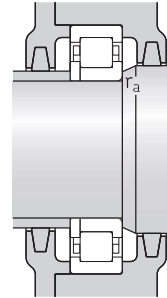
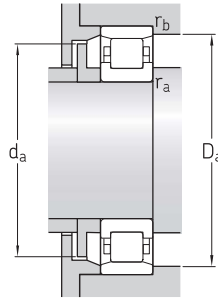
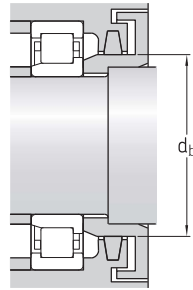
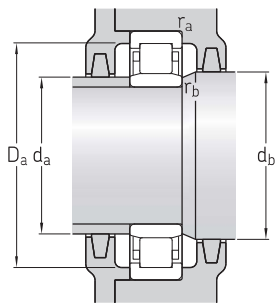

Angle ring

Dimensions				Abutment and fillet dimensions										Calculation factor k_r	Angle ring Designation	Mass	Dimensions	
d	d_1	D_1	F, E	$r_{1,2}$	$r_{3,4}$	s	d_a	d_a	d_b, D_a	D_a	r_a	r_b	B_1				B_2	
mm	mm	mm	mm	mm	mm	mm	mm	mm	mm	mm	mm	mm	mm	mm	mm	mm	mm	
55 cont.	77,5	100,3	70,5	2	2	-	65	-	80	109,2	2	-	0,15	-	-	-	-	
	77,5	100,3	70,5	2	2	3,5	65	68	80	109,2	2	-	0,25	HJ 2311 EC	0,19	9	15,5	
	-	100,3	70,5	2	2	3,5	65	68	73	109,2	2	2	0,25	HJ 2311 EC	0,19	9	15,5	
	77,5	100,3	70,5	2	2	-	65	-	80	109,2	2	-	0,25	-	-	-	-	
60	-	109,45	77,2	2,1	2,1	2,6	69	74	79	126	2	2	0,15	-	-	-	-	
	85,2	109,45	77,2	2,1	2,1	2,6	69	74	88	126	2	-	0,15	-	-	-	-	
	-	81,8	69,5	1,1	1	2,9	64,6	68	71	88	1	1	0,15	-	-	-	-	
	77,5	-	100	1,5	1,5	1,4	68	98	102	103	1,5	1,5	0,12	-	-	-	-	
	-	95	72	1,5	1,5	1,4	68	70	74	101	1,5	1,5	0,15	HJ 212 EC	0,1	6	10	
	77,5	95	72	1,5	1,5	1,4	68	70	80	101	1,5	-	0,15	HJ 212 EC	0,1	6	10	
	77,5	95	72	1,5	1,5	-	68	-	80	101	1,5	-	0,15	-	-	-	-	
	-	95	72	1,5	1,5	1,4	68	70	74	101	1,5	1,5	0,2	HJ 212 EC	0,1	6	10	
	77,5	95	72	1,5	1,5	1,4	68	70	80	101	1,5	-	0,2	HJ 212 EC	0,1	6	10	
	77,5	95	72	1,5	1,5	-	68	-	80	101	1,5	-	0,2	-	-	-	-	
	84,3	-	115	2,1	2,1	2,1	72	113	118	119	2	2	0,12	-	-	-	-	
	-	108,5	77	2,1	2,1	2,1	72	74	79	118,1	2	2	0,15	HJ 312 EC	0,23	9	14,5	
	84,3	108,5	77	2,1	2,1	2,1	72	74	87	118,1	2	-	0,15	HJ 312 EC	0,23	9	14,5	
	84,3	108,5	77	2,1	2,1	-	72	-	87	118,1	2	-	0,15	-	-	-	-	
	-	108,5	77	2,1	2,1	3,6	72	74	79	118,1	2	2	0,25	HJ 2312 EC	0,24	9	16	
	84,3	108,5	77	2,1	2,1	3,6	72	74	87	118,1	2	-	0,25	HJ 2312 EC	0,24	9	16	
84,3	108,5	77	2,1	2,1	-	72	-	87	118,1	2	-	0,25	-	-	-	-		
-	118,5	83	2,1	2,1	2,5	74	80	85	136	2	2	0,15	-	-	-	-		
91,8	118,5	83	2,1	2,1	2,5	74	80	94	136	2	-	0,15	-	-	-	-		
65	-	86,6	74,5	1,1	1	2,9	69,6	72	76	94	1	1	0,15	-	-	-	-	
	-	88,5	74	1,1	1	1	69,6	72	76	94	1	1	0,1	-	-	-	-	
	-	103,2	78,5	1,5	1,5	1,4	74	76	81	110,6	1,5	1,5	0,15	HJ 213 EC	0,12	6	10	
	84,4	-	108,5	1,5	1,5	1,4	74	106	111	112	1,5	1,5	0,12	-	-	-	-	
	84,4	103,2	78,5	1,5	1,5	1,4	74	76	87	110,6	1,5	-	0,15	HJ 213 EC	0,12	6	10	
	84,4	103,2	78,5	1,5	1,5	-	76	-	87	110,6	1,5	-	0,15	-	-	-	-	
	-	103,2	78,5	1,5	1,5	1,9	74	76	81	110,6	1,5	1,5	0,2	HJ 2213 EC	0,12	6	10,5	
	84,4	103,2	78,5	1,5	1,5	1,9	74	76	87	110,6	1,5	-	0,2	HJ 2213 EC	0,12	6	10,5	
	84,4	103,2	78,5	1,5	1,5	-	74	-	87	110,6	1,5	-	0,2	-	-	-	-	
	90,5	-	124,5	2,1	2,1	2,2	77	122	127	129	2	2	0,12	-	-	-	-	
	-	117,4	82,5	2,1	2,1	2,2	77	80	85	127,8	2	2	0,15	HJ 313 EC	0,27	10	15,5	
	90,5	117,4	82,5	2,1	2,1	2,2	77	80	93	127,8	2	-	0,15	HJ 313 EC	0,27	10	15,5	



6.1 Single row cylindrical roller bearings

d 65 – 75 mm

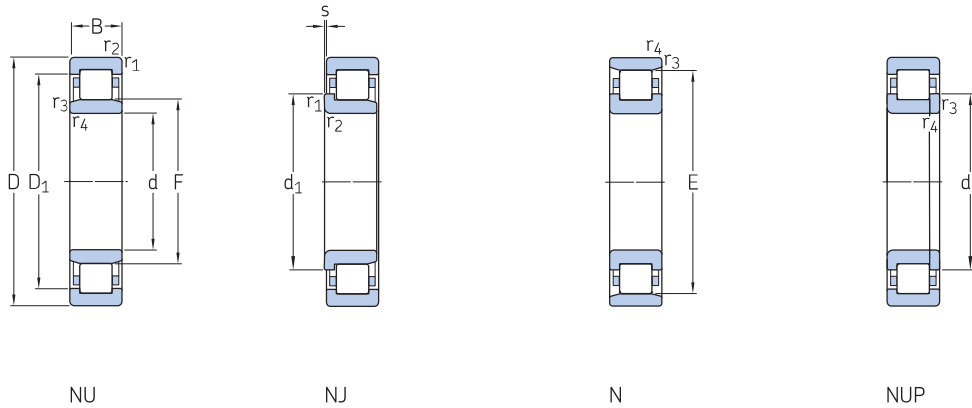

6.1

Principal dimensions			Basic load ratings		Fatigue load limit	Speed ratings		Mass	Designations Bearing with standard cage	Alternative standard cage ¹⁾
d	D	B	C	C ₀		Reference speed	Limiting speed			
mm			kN		kN	r/min		kg	–	
65 cont.	140	33	212	196	25,5	5 300	6 000	2,35	▶ NUP 313 ECP	J, M, ML, PH
	140	48	285	290	38	5 300	6 000	3,2	▶ NU 2313 ECP	ML, PH
	140	48	285	290	38	5 300	6 000	3,35	▶ NJ 2313 ECP	ML, PH
	140	48	285	290	38	5 300	6 000	3,45	▶ NUP 2313 ECP	ML, PH
	160	37	183	190	24	4 800	5 600	3,55	▶ NU 413	–
	160	37	183	190	24	4 800	5 600	3,65	▶ NJ 413	–
70	110	20	56,1	67	8	7 000	11 000	0,7	▶ NU 1014 ML	–
	110	20	76,5	93	12	7 000	7 000	0,61	▶ NU 1014 ECP	–
	125	24	137	137	18	6 000	6 300	1,1	▶ N 214 ECP	M
	125	24	137	137	18	6 000	6 300	1,15	▶ NU 214 ECP	J, M, ML, PH
	125	24	137	137	18	6 000	6 300	1,2	▶ NJ 214 ECP	J, M, ML, PH
	125	24	137	137	18	6 000	6 300	1,2	▶ NUP 214 ECP	J, M, ML, PH
	125	31	180	193	25,5	6 000	6 300	1,5	▶ NJ 2214 ECP	J, M, ML, PH
	125	31	180	193	25,5	6 000	6 300	1,5	▶ NU 2214 ECP	J, M, ML, PH
	125	31	180	193	25,5	6 000	6 300	1,55	▶ NUP 2214 ECP	J, M, ML, PH
	150	35	236	228	29	4 800	5 600	2,65	▶ N 314 ECP	M
	150	35	236	228	29	4 800	5 600	2,7	▶ NU 314 ECP	J, M, ML, PH
	150	35	236	228	29	4 800	5 600	2,75	▶ NJ 314 ECP	J, M, ML, PH
75	150	35	236	228	29	4 800	5 600	2,85	▶ NUP 314 ECP	J, M, ML, PH
	150	51	315	325	41,5	4 800	5 600	3,95	▶ NU 2314 ECP	ML, PH
	150	51	315	325	41,5	4 800	5 600	4	▶ NJ 2314 ECP	ML, PH
	150	51	315	325	41,5	4 800	5 600	4,15	▶ NUP 2314 ECP	ML, PH
	180	42	229	240	30	4 300	5 000	5,25	▶ NU 414	MA
	180	42	229	240	30	4 300	5 000	5,45	▶ NJ 414	MA
	115	20	58,3	71	8,5	6 700	10 000	0,75	▶ NU 1015 ML	M
	130	25	150	156	20,4	5 600	6 000	1,2	▶ N 215 ECP	–
	130	25	150	156	20,4	5 600	6 000	1,25	▶ NU 215 ECP	J, M, ML, PH
	130	25	150	156	20,4	5 600	6 000	1,3	▶ NJ 215 ECP	J, M, ML, PH
	130	25	150	156	20,4	5 600	6 000	1,3	▶ NUP 215 ECP	J, M, ML, PH
	130	31	186	208	27	5 600	6 000	1,6	▶ NJ 2215 ECP	J, ML, PH
130	31	186	208	27	5 600	6 000	1,6	▶ NU 2215 ECP	J, ML, PH	
130	31	186	208	27	5 600	6 000	1,6	▶ NUP 2215 ECP	J, ML, PH	
160	37	280	265	33,5	4 500	5 300	3,3	▶ N 315 ECP	M	

SKF Explorer bearing

▶ Popular item

¹⁾ When ordering bearings with an alternative standard cage the suffix of the standard cage has to be replaced by the suffix of the alternative cage.

For example NU .. ECP becomes NU .. ECML (for permissible speed → [page 511](#)).

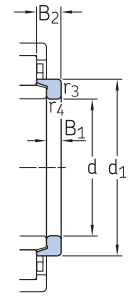
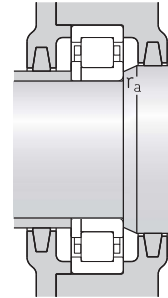
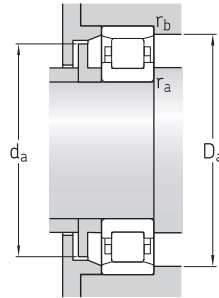
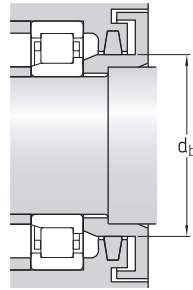
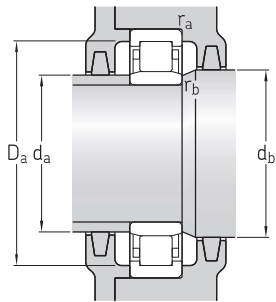

Angle ring

Dimensions				Abutment and fillet dimensions										Calculation factor k_r	Angle ring Designation	Mass	Dimensions	
d	d_1	D_1	F, E	$r_{1,2}$	$r_{3,4}$	s	d_a	d_a	d_b, D_a	D_a	r_a	r_b	B_1				B_2	
mm	mm	mm	mm	mm	mm	mm	mm	mm	mm	mm	mm	mm	mm	mm	mm	mm	mm	
65 cont.	90,5	117,4	82,5	2,1	2,1	–	77	–	93	127,8	2	–	0,15	–	–	–	–	
	–	117,4	82,5	2,1	2,1	4,7	77	80	85	127,8	2	2	0,25	HJ 2313 EC	0,3	10	18	
	90,5	117,4	82,5	2,1	2,1	–	77	–	93	127,8	2	–	0,25	HJ 2313 EC	0,3	10	18	
65	90,5	117,4	82,5	2,1	2,1	–	77	–	93	127,8	2	–	0,25	–	–	–	–	
	–	126,85	89,3	2,1	2,1	2,6	78	86	91	146	2	2	0,15	HJ 413	0,42	11	18	
	98,5	126,85	89,3	2,1	2,1	2,6	78	86	101	146	2	–	0,15	HJ 413	0,42	11	18	
70	–	95,7	80	1,1	1	3	74,6	78	82	104	1	1	0,15	–	–	–	–	
	–	97,55	79,5	1,1	1	1,3	74,6	78	82	104	1	1	0,1	HJ 1014 EC	0,082	5	10	
	89,4	–	113,5	1,5	1,5	1,2	79	111	116	117	1,5	1,5	0,12	–	–	–	–	
70	–	108,3	83,5	1,5	1,5	1,2	79	81	86	115,4	1,5	1,5	0,15	HJ 214 EC	0,15	7	11	
	89,4	108,3	83,5	1,5	1,5	1,2	79	81	92	115,4	1,5	–	0,15	HJ 214 EC	0,15	7	11	
	89,4	108,3	83,5	1,5	1,5	–	79	–	92	115,4	1,5	–	0,15	–	–	–	–	
70	89,4	108,2	83,5	1,5	1,5	1,7	79	81	92	115,4	1,5	–	0,2	HJ 2214 EC	0,15	7	11,5	
	–	108,2	83,5	1,5	1,5	1,7	79	81	86	115,4	1,5	1,5	0,2	HJ 2214 EC	0,15	7	11,5	
	89,4	108,2	83,5	1,5	1,5	–	79	–	92	115,4	1,5	–	0,2	–	–	–	–	
70	97,3	–	133	2,1	2,1	1,8	82	130	136	138	2	2	0,12	–	–	–	–	
	–	125,6	89	2,1	2,1	1,8	82	86	92	137,5	2	2	0,15	HJ 314 EC	0,32	10	15,5	
	97,3	125,6	89	2,1	2,1	1,8	82	86	100	137,5	2	–	0,15	HJ 314 EC	0,32	10	15,5	
70	97,3	125,6	89	2,1	2,1	–	82	–	100	137,5	2	–	0,15	–	–	–	–	
	–	125,6	89	2,1	2,1	4,8	82	86	92	137,5	2	2	0,25	HJ 2314 EC	0,35	10	18,5	
	97,3	125,6	89	2,1	2,1	4,8	82	86	100	137,5	2	–	0,25	HJ 2314 EC	0,35	10	18,5	
70	97,3	125,6	89	2,1	2,1	–	82	–	100	137,5	2	–	0,25	–	–	–	–	
	–	141	100	3	3	3,5	87	97	102	164	2,5	2,5	0,15	HJ 414	0,61	12	20	
	110	141	100	3	3	3,5	87	97	113	164	2,5	–	0,15	HJ 414	0,61	12	20	
75	–	100,4	85	1,1	1	3	80	83	87	109	1	1	0,15	–	–	–	–	
	94,3	–	118,5	1,5	1,5	1,2	84	116	121	122	1,5	1,5	0,12	–	–	–	–	
	–	113,3	88,5	1,5	1,5	1,2	84	86	91	121,5	1,5	1,5	0,15	HJ 215 EC	0,16	7	11	
75	94,3	113,3	88,5	1,5	1,5	1,2	84	86	97	121,5	1,5	–	0,15	HJ 215 EC	0,16	7	11	
	94,3	113,3	88,5	1,5	1,5	–	84	–	97	121,5	1,5	–	0,15	–	–	–	–	
	94,3	113,2	88,5	1,5	1,5	1,7	84	86	97	121,5	1,5	–	0,2	–	–	–	–	
75	–	113,2	88,5	1,5	1,5	1,7	84	86	91	121,5	1,5	1,5	0,2	–	–	–	–	
	94,3	113,2	88,5	1,5	1,5	–	84	–	97	121,5	1,5	–	0,2	–	–	–	–	
	104	–	143	2,1	2,1	1,8	87	140	146	148	2	2	0,12	–	–	–	–	



6.1 Single row cylindrical roller bearings

d 75 – 85 mm

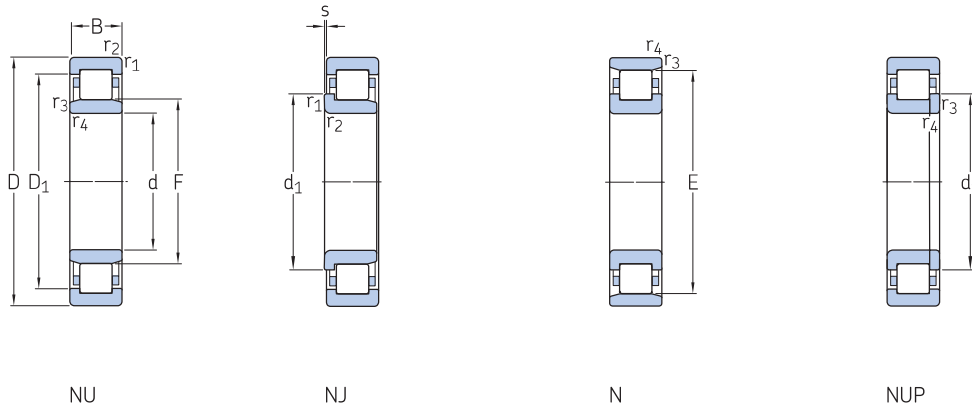

Principal dimensions			Basic load ratings		Fatigue load limit	Speed ratings		Mass	Designations Bearing with standard cage	Alternative standard cage ¹⁾
d	D	B	C	C ₀		Reference speed	Limiting speed			
mm			kN		kN	r/min		kg	–	
75 cont.	160	37	280	265	33,5	4 500	5 300	3,3	▶ NU 315 ECP	J, M, ML, PH
	160	37	280	265	33,5	4 500	5 300	3,35	▶ NJ 315 ECP	J, M, ML, PH
	160	37	280	265	33,5	4 500	5 300	3,45	▶ NUP 315 ECP	J, M, ML, PH
	160	55	380	400	50	4 500	5 300	4,8	▶ NU 2315 ECP	J, ML
	160	55	380	400	50	4 500	5 300	5	▶ NJ 2315 ECP	J, ML
	160	55	380	400	50	4 500	5 300	5,1	▶ NUP 2315 ECP	J, ML
	190	45	264	280	34	4 000	4 800	6,2	NU 415	–
	190	45	264	280	34	4 000	4 800	6,4	NJ 415	–
	80	125	22	64,4	78	9,8	6 300	6 300	0,88	▶ NU 1016
125		22	99	127	16,3	6 000	9 500	1,05	▶ NJ 1016 ECML	M
140		26	160	166	21,2	5 300	5 600	1,55	▶ N 216 ECP	–
140		26	160	166	21,2	5 300	5 600	1,55	▶ NJ 216 ECP	J, M, ML, PH
140		26	160	166	21,2	5 300	5 600	1,55	▶ NU 216 ECP	J, M, ML, PH
140		26	160	166	21,2	5 300	5 600	1,55	▶ NUP 216 ECP	J, M, ML, PH
140		33	212	245	31	5 300	5 600	1,95	▶ NU 2216 ECP	J, M, ML, PH
140		33	212	245	31	5 300	5 600	2	▶ NUP 2216 ECP	J, M, ML, PH
140		33	212	245	31	5 300	5 600	2,05	▶ NJ 2216 ECP	J, M, ML, PH
170		39	300	290	36	4 300	5 000	3,85	▶ NU 316 ECP	J, M, ML, PH
170		39	300	290	36	4 300	5 000	3,9	▶ N 316 ECP	M
170		39	300	290	36	4 300	5 000	4	▶ NJ 316 ECP	J, M, ML, PH
170		39	300	290	36	4 300	5 000	4,1	▶ NUP 316 ECP	J, M, ML, PH
170		58	415	440	55	4 300	5 000	5,75	▶ NU 2316 ECP	M, ML
170		58	415	440	55	4 300	5 000	5,95	▶ NJ 2316 ECP	M, ML
170		58	415	440	55	4 300	5 000	6	NUP 2316 ECP	M, ML
200		48	303	320	39	3 800	4 500	7,25	▶ NU 416	–
200		48	303	320	39	3 800	4 500	7,55	NJ 416	–
85	130	22	68,2	86,5	10,8	6 000	9 000	1,05	▶ NU 1017 ML	–
	130	22	68,2	86,5	10,8	6 000	9 000	1,1	NJ 1017 ML	–
	130	22	68,2	86,5	10,8	6 000	9 000	1,1	NUP 1017 ML	–
	150	28	190	200	25	4 800	5 300	1,9	▶ N 217 ECP	M
	150	28	190	200	25	4 800	5 300	1,9	▶ NJ 217 ECP	J, M, ML
	150	28	190	200	25	4 800	5 300	1,9	▶ NU 217 ECP	J, M, ML
	150	28	190	200	25	4 800	5 300	1,9	▶ NUP 217 ECP	J, M, ML
	150	36	250	280	34,5	4 800	5 300	2,5	▶ NU 2217 ECP	J, M, ML, PH
	150	36	250	280	34,5	4 800	5 300	2,55	▶ NJ 2217 ECP	J, M, ML, PH

SKF Explorer bearing

▶ Popular item

¹⁾ When ordering bearings with an alternative standard cage the suffix of the standard cage has to be replaced by the suffix of the alternative cage.

For example NU .. ECP becomes NU .. ECML (for permissible speed → [page 511](#)).

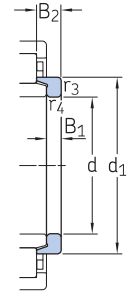
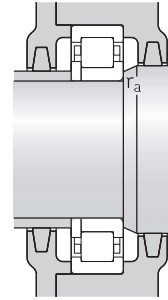
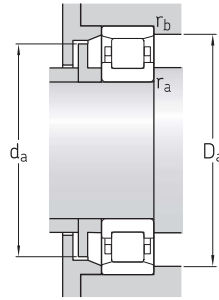
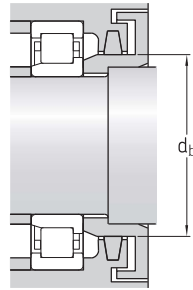
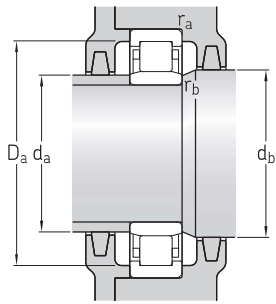

Angle ring

Dimensions				Abutment and fillet dimensions										Calculation factor k_r	Angle ring Designation	Mass	Dimensions	
d	d_1	D_1	F, E	$r_{1,2}$	$r_{3,4}$	s	d_a	d_a	d_b, D_a	D_a	r_a	r_b	k_r				Designation	Mass
mm	mm	mm	mm	mm	mm	mm	mm	mm	mm	mm	mm	mm	mm	mm	mm	mm	mm	
75 cont.	-	135	95	2,1	2,1	1,8	87	92	97	148	2	2	0,15	HJ 315 EC	0,39	11	16,5	
	104	135	95	2,1	2,1	1,8	87	92	107	148	2	-	0,15	HJ 315 EC	0,39	11	16,5	
	104	135	95	2,1	2,1	-	87	-	107	148	2	-	0,15	-	-	-	-	
	-	135	95	2,1	2,1	4,8	87	92	97	148	2	2	0,25	HJ 2315 EC	0,42	11	19,5	
	104	135	95	2,1	2,1	4,8	87	92	107	148	2	-	0,25	HJ 2315 EC	0,42	11	19,5	
	104	135	95	2,1	2,1	-	87	-	107	148	2	-	0,25	-	-	-	-	
	-	149,1	104,5	3	3	3,8	91	101	107	174	2,5	2,5	0,15	HJ 415	0,71	13	21,5	
	116	149,1	104,5	3	3	3,8	91	101	119	174	2,5	-	0,15	HJ 415	0,71	13	21,5	
	80	-	108,55	91,5	1,1	1	3,3	86	90	94	119	1	1	0,1	-	-	-	-
		96,2	111,6	91,5	1,1	1	1,5	86	90	99	119	1	-	0,15	-	-	-	-
		101	-	127,3	2	2	1,4	90	125	130	131	2	2	0,12	-	-	-	-
		101	121,7	95,3	2	2	1,4	90	93	104	129,8	2	-	0,15	HJ 216 EC	0,21	8	12,5
-		121,7	95,3	2	2	1,4	90	93	98	129,8	2	2	0,15	HJ 216 EC	0,21	8	12,5	
101		121,7	95,3	2	2	-	90	-	104	129,8	2	-	0,15	-	-	-	-	
-		121,7	95,3	2	2	1,4	90	93	98	129,8	2	2	0,2	HJ 216 EC	0,21	8	12,5	
101		121,7	95,3	2	2	-	90	-	104	129,8	2	-	0,2	-	-	-	-	
101		121,7	95,3	2	2	1,4	90	93	104	129,8	2	-	0,2	HJ 216 EC	0,21	8	12,5	
-		142,7	101	2,1	2,1	2,1	92	98	104	157,8	2	2	0,15	HJ 316 EC	0,44	11	17	
110		-	151	2,1	2,1	2,1	92	148	154	157	2	2	0,12	-	-	-	-	
110		142,7	101	2,1	2,1	2,1	92	98	113	157,8	2	-	0,15	HJ 316 EC	0,44	11	17	
85	-	114	96,5	1,1	1	3,3	91	94	99	123	1	1	0,15	-	-	-	-	
	101	114	96,5	1,1	1	3,3	91	94	104	123	1	-	0,15	-	-	-	-	
	101	114	96,5	1,1	1	-	91	-	104	123	1	-	0,15	-	-	-	-	
	107	-	136,5	2	2	1,5	96	134	139	140	2	2	0,12	-	-	-	-	
	107	130,3	100,5	2	2	1,5	96	98	110	138,5	2	-	0,15	HJ 217 EC	0,24	8	12,5	
	-	130,3	100,5	2	2	1,5	96	98	103	138,5	2	2	0,15	HJ 217 EC	0,24	8	12,5	
	107	130,3	100,5	2	2	-	96	-	110	138,5	2	-	0,15	-	-	-	-	
	-	130,3	100,5	2	2	2	96	98	103	138,5	2	2	0,2	-	-	-	-	
	107	130,3	100,5	2	2	2	96	98	110	138,5	2	-	0,2	-	-	-	-	



6.1 Single row cylindrical roller bearings

d 85 – 95 mm

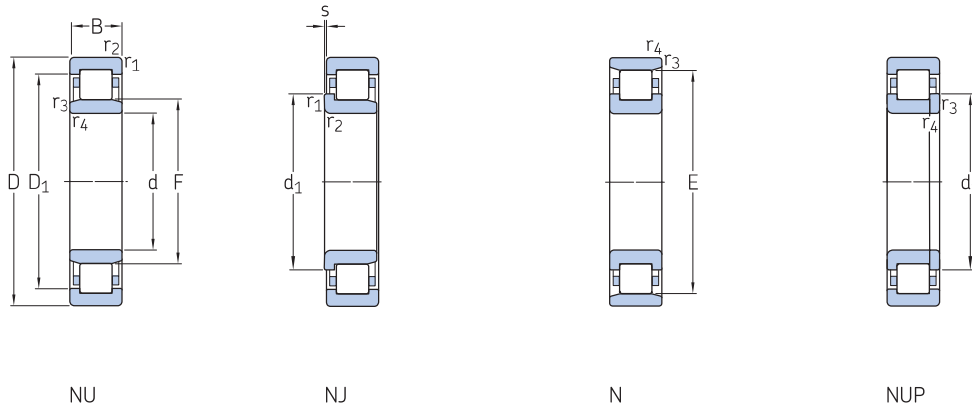

6.1

Principal dimensions			Basic load ratings		Fatigue load limit	Speed ratings		Mass	Designations Bearing with standard cage	Alternative standard cage ¹⁾	
d	D	B	C	C ₀		Reference speed	Limiting speed				
mm			kN		kN	r/min		kg	–		
85 cont.	150	36	250	280	34,5	4 800	5 300	2,6	▶ NUP 2217 ECP	J, M, ML, PH	
	180	41	340	335	41,5	4 000	4 800	4,55	▶ N 317 ECP	M	
	180	41	340	335	41,5	4 000	4 800	4,65	▶ NU 317 ECP	J, M, ML, PH	
	180	41	340	335	41,5	4 000	4 800	4,8	▶ NJ 317 ECP	J, M, ML, PH	
	180	41	340	335	41,5	4 000	4 800	4,9	▶ NUP 317 ECP	J, M, ML, PH	
	180	60	455	490	60	4 000	4 800	6,85	▶ NU 2317 ECP	J, M, ML	
	180	60	455	490	60	4 000	4 800	7	▶ NJ 2317 ECP	J, M, ML	
	180	60	455	490	60	4 000	4 800	7	▶ NUP 2317 ECP	J, M, ML	
	90	140	24	80,9	104	12,7	5 600	8 500	1,35	▶ NU 1018 ML	M
		140	24	80,9	104	12,7	5 600	8 500	1,4	▶ NJ 1018 ML	M
160		30	208	220	27	4 500	5 000	2,3	▶ N 218 ECP	M	
160		30	208	220	27	4 500	5 000	2,3	▶ NJ 218 ECP	J, M, ML	
160		30	208	220	27	4 500	5 000	2,3	▶ NU 218 ECP	J, M, ML	
160		30	208	220	27	4 500	5 000	2,45	▶ NUP 218 ECP	J, M, ML	
160		40	280	315	39	4 500	5 000	3,15	▶ NU 2218 ECP	J, M, ML	
160		40	280	315	39	4 500	5 000	3,25	▶ NJ 2218 ECP	J, M, ML	
160		40	280	315	39	4 500	5 000	3,3	▶ NUP 2218 ECP	J, M, ML	
190		43	365	360	43	3 800	4 500	5,25	▶ NU 318 ECP	J, M, ML	
190		43	365	360	43	3 800	4 500	5,3	▶ N 318 ECP	M	
190		43	365	360	43	3 800	4 500	5,45	▶ NJ 318 ECP	J, M, ML	
190		43	365	360	43	3 800	4 500	5,55	▶ NUP 318 ECJ	M, ML, P	
190		64	500	540	65,5	3 800	4 500	8	▶ NU 2318 ECP	J, M, ML	
190		64	500	540	65,5	3 800	4 500	8,15	▶ NJ 2318 ECP	J, M, ML	
190		64	500	540	65,5	3 800	4 500	8,25	▶ NUP 2318 ECP	J, M, ML	
225		54	380	415	48	3 400	4 000	10	▶ NU 418	M	
95		145	24	84,2	110	13,2	5 300	8 000	1,45	▶ NU 1019 ML	–
	170	32	255	265	32,5	4 300	4 800	2,85	▶ N 219 ECP	–	
	170	32	255	265	32,5	4 300	4 800	2,85	▶ NU 219 ECP	J, M, ML	
	170	32	255	265	32,5	4 300	4 800	2,9	▶ NJ 219 ECP	J, M, ML	
	170	32	255	265	32,5	4 300	4 800	2,9	▶ NUP 219 ECP	J, M, ML	
	170	43	325	375	45,5	4 300	4 800	3,8	▶ NU 2219 ECP	J, ML	
	170	43	325	375	45,5	4 300	4 800	3,95	▶ NJ 2219 ECP	J, ML	
	170	43	325	375	45,5	4 300	4 800	4	▶ NUP 2219 ECP	J, ML	
	200	45	390	390	46,5	3 600	4 300	6,2	▶ N 319 ECP	M	

SKF Explorer bearing

▶ Popular item

¹⁾ When ordering bearings with an alternative standard cage the suffix of the standard cage has to be replaced by the suffix of the alternative cage.

For example NU .. ECP becomes NU .. ECML (for permissible speed → [page 511](#)).

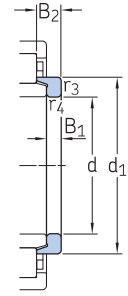
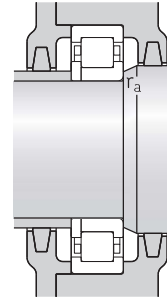
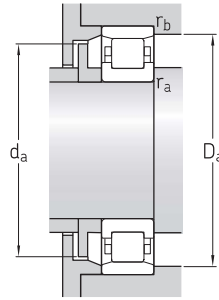
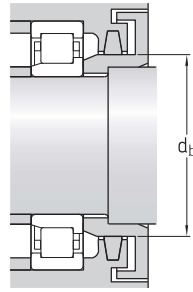
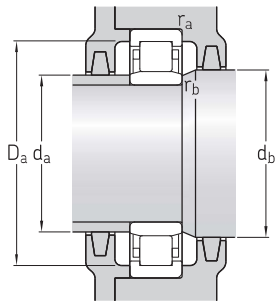

Angle ring

Dimensions				Abutment and fillet dimensions										Calculation factor k_r	Angle ring Designation	Mass	Dimensions	
d	d_1	D_1	F, E	$r_{1,2}$	$r_{3,4}$	s	d_a	d_a	d_b, D_a	D_a	r_a	r_b	B_1				B_2	
mm	mm	mm	mm	mm	mm	mm	mm	mm	mm	mm	mm	mm	mm	mm	mm	mm	mm	
85 cont.	107	130,3	100,5	2	2	-	96	-	110	138,5	2	-	0,2	-	-	-	-	
	117	-	160	3	3	2,3	99	157	163	166	2,5	2,5	0,12	-	-	-	-	
	-	151,4	108	3	3	2,3	99	105	111	165,5	2,5	2,5	0,15	HJ 317 EC	0,55	12	18,5	
	117	151,4	108	3	3	2,3	99	105	120	165,5	2,5	-	0,15	HJ 317 EC	0,55	12	18,5	
	117	151,4	108	3	3	-	99	-	120	165,5	2,5	-	0,15	-	-	-	-	
-	151,4	108	3	3	5,8	99	105	111	165,5	2,5	2,5	0,25	HJ 2317 EC	0,59	12	22		
117	151,4	108	3	3	5,8	99	105	120	165,5	2,5	-	0,25	HJ 2317 EC	0,59	12	22		
117	151,4	108	3	3	-	99	-	120	165,5	2,5	-	0,25	-	-	-	-		
90	-	122,1	103	1,5	1,1	3,5	96	101	106	133	1,5	1	0,15	-	-	-	-	
	108	122,1	103	1,5	1,1	3,5	96	101	111	133	1,5	-	0,15	-	-	-	-	
	114	-	145	2	2	1,8	101	142	148	149	2	2	0,12	-	-	-	-	
	114	138,45	107	2	2	1,8	101	104	117	149	2	-	0,15	HJ 218 EC	0,31	9	14	
	-	138,45	107	2	2	1,8	101	104	110	149	2	2	0,15	HJ 218 EC	0,31	9	14	
	114	138,45	107	2	2	-	101	-	117	149	2	-	0,15	-	-	-	-	
	-	138,5	107	2	2	2,6	101	104	110	149	2	2	0,2	HJ 2218 EC	0,31	9	15	
	114	138,5	107	2	2	2,6	101	104	117	149	2	-	0,2	HJ 2218 EC	0,31	9	15	
	114	138,5	107	2	2	-	101	-	117	149	2	-	0,2	-	-	-	-	
	-	160,3	113,5	3	3	2,5	104	110	116	175,3	2,5	2,5	0,15	HJ 318 EC	0,62	12	18,5	
	124	-	169,5	3	3	2,5	104	166	173	175	2,5	2,5	0,12	-	-	-	-	
	124	160,3	113,5	3	3	2,5	104	110	127	175,3	2,5	-	0,15	HJ 318 EC	0,62	12	18,5	
	124	160,3	113,5	3	3	-	104	-	127	175,3	2,5	-	0,15	-	-	-	-	
	-	160,3	113,5	3	3	6	104	110	116	175,3	2,5	2,5	0,25	HJ 2318 EC	0,66	12	22	
	124	160,3	113,5	3	3	6	104	110	127	175,3	2,5	-	0,25	HJ 2318 EC	0,66	12	22	
124	160,3	113,5	3	3	-	104	-	127	175,3	2,5	-	0,25	-	-	-	-		
-	179,5	123,5	4	4	4,9	108	120	126	205	3	3	0,15	-	-	-	-		
95	-	127,1	108	1,5	1,1	3,5	101	106	111	138	1,5	1	0,15	-	-	-	-	
	120	-	154,5	2,1	2,1	1,7	107	152	157	159	2	2	0,12	-	-	-	-	
	-	147,4	112,5	2,1	2,1	1,7	107	110	115	157,8	2	2	0,15	HJ 219 EC	0,33	9	14	
	120	147,4	112,5	2,1	2,1	1,7	107	110	123	157,8	2	-	0,15	HJ 219 EC	0,33	9	14	
	120	147,4	112,5	2,1	2,1	-	107	-	123	157,8	2	-	0,15	-	-	-	-	
	-	147,4	112,5	2,1	2,1	3	107	110	115	157,8	2	2	0,2	-	-	-	-	
	120	147,4	112,5	2,1	2,1	3	107	110	123	157,8	2	-	0,2	-	-	-	-	
	120	147,4	112,5	2,1	2,1	-	107	-	123	157,8	2	-	0,2	-	-	-	-	
	132	-	177,5	3	3	2,9	110	174	181	185	2,5	2,5	0,12	-	-	-	-	



6.1 Single row cylindrical roller bearings

d 95 – 105 mm

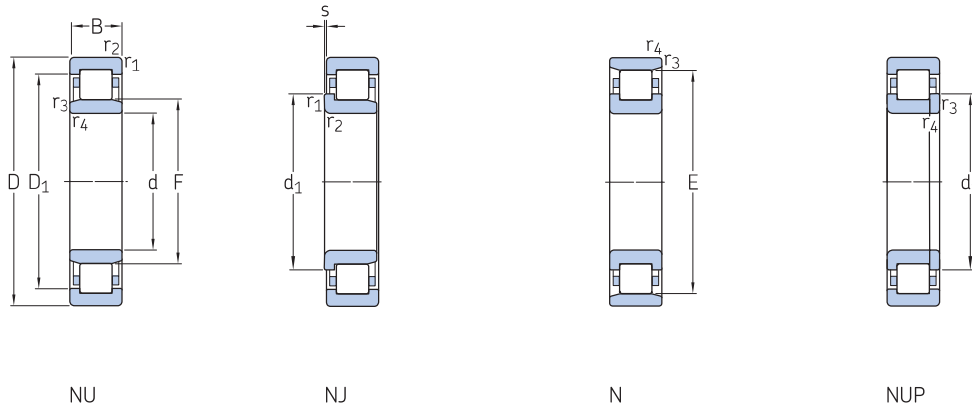

Principal dimensions			Basic load ratings		Fatigue load limit	Speed ratings		Mass	Designations Bearing with standard cage	Alternative standard cage ¹⁾
d	D	B	C	C ₀		Reference speed	Limiting speed			
mm			kN		kN	r/min		kg	–	
95 cont.	200	45	390	390	46,5	3 600	4 300	6,2	▶ NU 319 ECP	J, M, ML
	200	45	390	390	46,5	3 600	4 300	6,3	▶ NJ 319 ECP	J, M, ML
	200	45	390	390	46,5	3 600	4 300	6,3	▶ NUP 319 ECP	J, M, ML
	200	67	530	585	69,5	3 600	4 300	9,35	▶ NU 2319 ECP	J, ML
	200	67	530	585	69,5	3 600	4 300	9,55	▶ NJ 2319 ECJ	J, M, P
	200	67	530	585	69,5	3 600	4 300	9,7	▶ NUP 2319 ECJ	ML, P
	240	55	413	455	52	3 200	3 600	13,5	▶ NU 419 M	–
100	150	24	85,8	114	13,7	5 000	7 500	1,45	▶ NU 1020 ML	M
	180	34	285	305	36,5	4 000	4 500	3,35	▶ NU 220 ECP	J, M, ML
	180	34	285	305	36,5	4 000	4 500	3,45	▶ N 220 ECP	–
	180	34	285	305	36,5	4 000	4 500	3,45	▶ NJ 220 ECP	J, M, ML
	180	34	285	305	36,5	4 000	4 500	3,6	▶ NUP 220 ECP	J, M, ML
	180	46	380	450	54	4 000	4 500	4,75	▶ NU 2220 ECP	J, M, ML, PH
	180	46	380	450	54	4 000	4 500	4,8	▶ NJ 2220 ECP	J, M, ML, PH
	180	46	380	450	54	4 000	4 500	4,8	▶ NUP 2220 ECP	J, M, ML, PH
	215	47	450	440	51	3 200	3 800	7,35	▶ N 320 ECP	M
	215	47	450	440	51	3 200	3 800	7,45	▶ NU 320 ECP	J, M, ML
	215	47	450	440	51	3 200	3 800	7,65	▶ NJ 320 ECJ	M, ML, P
	215	47	450	440	51	3 200	3 800	7,7	▶ NUP 320 ECJ	M, ML, P
	215	73	670	735	85	3 200	3 800	12	▶ NJ 2320 ECJ	M, ML, P
	215	73	670	735	85	3 200	3 800	12	▶ NU 2320 ECP	J, M, ML
	215	73	670	735	85	3 200	3 800	12,5	▶ NUP 2320 ECJ	M, ML, P
	250	58	457	520	58,5	3 000	3 600	15,5	▶ NU 420 M	–
105	160	26	101	137	16	4 800	7 500	1,9	▶ NU 1021 ML	–
	190	36	300	315	36,5	3 800	4 300	3,9	▶ N 221 ECP	–
	190	36	300	315	36,5	3 800	4 300	3,95	▶ NU 221 ECP	J, ML
	190	36	300	315	36,5	3 800	4 300	4	▶ NJ 221 ECP	J, ML
	190	36	300	315	36,5	3 800	4 300	4,2	▶ NUP 221 ECP	J, ML
	225	49	500	500	57	3 200	3 800	8,5	▶ NU 321 ECP	J, ML
	225	49	500	500	57	3 200	3 800	8,6	▶ NJ 321 ECP	–
	260	60	501	570	64	2 800	3 400	17,5	▶ NU 421 M	J, ML

SKF Explorer bearing

▶ Popular item

¹⁾ When ordering bearings with an alternative standard cage the suffix of the standard cage has to be replaced by the suffix of the alternative cage.

For example NU .. ECP becomes NU .. ECML (for permissible speed → [page 511](#)).

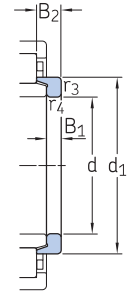
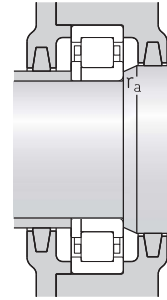
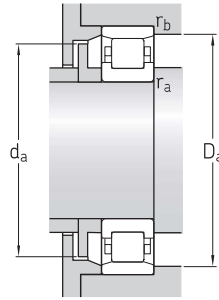
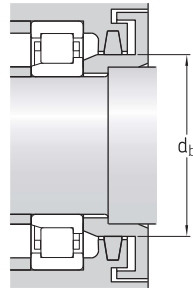
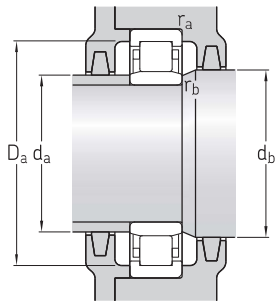

Angle ring

Dimensions				Abutment and fillet dimensions									Calculation factor k_r	Angle ring Designation	Mass	Dimensions	
d	d_1	D_1	F, E	$r_{1,2}$	$r_{3,4}$	s	d_a	d_a	d_b, D_a	D_a	r_a	r_b				B_1	B_2
mm	mm	mm	mm	mm	mm	mm	mm	mm	mm	mm	mm	mm	mm	mm	mm	mm	
95 cont.	–	168,3	121,5	3	3	2,9	110	118	125	185	2,5	2,5	0,15	HJ 319 EC	0,78	13	20,5
	132	168,3	121,5	3	3	2,9	110	118	135	185	2,5	–	0,15	HJ 319 EC	0,78	13	20,5
	132	168,3	121,5	3	3	–	110	–	135	185	2,5	–	0,15	–	–	–	–
	–	168,3	121,5	3	3	6,9	110	118	125	185	2,5	2,5	0,25	HJ 2319 EC	0,76	13	24,5
	132	168,3	121,5	3	3	6,9	110	118	135	185	2,5	–	0,25	HJ 2319 EC	0,76	13	24,5
	132	168,3	121,5	3	3	–	110	–	135	185	2,5	–	0,25	–	–	–	–
100	–	188	133,5	4	4	5	114	130	136	220	3	3	0,15	–	–	–	–
	–	132,1	113	1,5	1,1	3,5	106	111	116	143	1,5	1	0,15	–	–	–	–
	–	155,6	119	2,1	2,1	1,7	113	116	122	167,5	2	2	0,15	HJ 220 EC	0,43	10	15
	127	–	163	2,1	2,1	1,7	113	160	166	168	2	2	0,12	–	–	–	–
	127	155,6	119	2,1	2,1	1,7	113	116	130	167,5	2	–	0,15	HJ 220 EC	0,43	10	15
	127	155,6	119	2,1	2,1	–	113	–	130	167,5	2	–	0,15	–	–	–	–
	–	155,6	119	2,1	2,1	2,5	113	116	122	167,5	2	2	0,2	HJ 2220 EC	0,43	10	16
	127	155,6	119	2,1	2,1	2,5	113	116	130	167,5	2	–	0,2	HJ 2220 EC	0,43	10	16
	127	155,6	119	2,1	2,1	–	113	–	130	167,5	2	–	0,2	–	–	–	–
	139	–	191,5	3	3	2,9	114	188	195	200	2,5	2,5	0,12	–	–	–	–
	–	181,1	127,5	3	3	2,9	114	124	131	199,6	2,5	2,5	0,15	HJ 320 EC	0,87	13	20,5
	139	181,1	127,5	3	3	2,9	114	124	142	199,6	2,5	–	0,15	HJ 320 EC	0,87	13	20,5
139	181,1	127,5	3	3	–	114	–	142	199,6	2,5	–	0,15	–	–	–	–	
139	181,1	127,5	3	3	5,9	114	124	142	199,6	2,5	–	0,25	HJ 2320 EC	0,91	13	23,5	
–	181,1	127,5	3	3	5,9	114	124	131	199,6	2,5	2,5	0,25	HJ 2320 EC	0,91	13	23,5	
139	181,1	127,5	3	3	–	114	–	142	199,6	2,5	–	0,25	–	–	–	–	
–	197,45	139	4	4	4,9	119	135	142	230	3	3	0,15	HJ 420	1,5	16	27	
105	–	140,8	119,5	2	1,1	3,8	111	117	122	151	2	1	0,15	–	–	–	–
	134	–	173	2,1	2,1	2	117	170	176	178	2	2	0,12	–	–	–	–
	–	164	125	2,1	2,1	2	117	122	128	177,3	2	2	0,15	HJ 221 EC	0,5	10	16
	134	164	125	2,1	2,1	2	117	122	137	177,3	2	–	0,15	HJ 221 EC	0,5	10	16
	134	164	125	2,1	2,1	–	117	–	137	177,3	2	–	0,15	–	–	–	–
	–	189	133	3	3	3,4	119	129	136	209,4	2,5	2,5	0,15	–	–	–	–
	145	–	201	3	3	3,4	119	198	205	210	2,5	2,5	0,12	–	–	–	–
	145	189	133	3	3	3,4	119	129	148	209,4	2,5	–	0,15	–	–	–	–
	–	206,3	144,5	4	4	4,9	124	140	147	241	3	3	0,15	–	–	–	–



6.1 Single row cylindrical roller bearings

d 110 – 120 mm

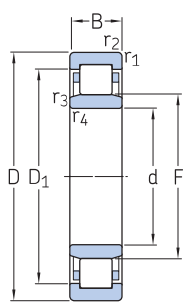

NU

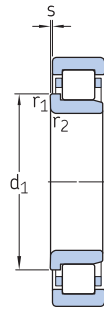

NJ

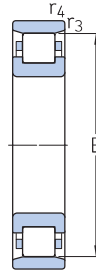

N

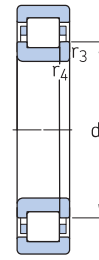

NUP

Principal dimensions			Basic load ratings		Fatigue load limit	Speed ratings		Mass	Designations Bearing with standard cage	Alternative standard cage ¹⁾
d	D	B	C	C ₀		Reference speed	Limiting speed			
mm			kN		kN	r/min		kg	–	
110	170	28	128	166	19,3	4 500	7 000	2,3	▶ NU 1022 ML	M
	200	38	335	365	42,5	3 600	4 000	4,7	▶ NU 222 ECP	J, M, ML
	200	38	335	365	42,5	3 600	4 000	4,8	▶ N 222 ECP	M
	200	38	335	365	42,5	3 600	4 000	4,8	▶ NJ 222 ECP	J, M, ML
	200	38	335	365	42,5	3 600	4 000	5	▶ NUP 222 ECP	J, M, ML
	200	53	440	520	61	3 600	4 000	6,7	▶ NJ 2222 ECP	J, ML
	200	53	440	520	61	3 600	4 000	6,7	▶ NU 2222 ECP	J, ML
	200	53	440	520	61	3 600	4 000	7	▶ NUP 2222 ECP	J, ML
	240	50	530	540	61	3 000	3 400	10	▶ N 322 ECP	M
	240	50	530	540	61	3 000	3 400	10,5	▶ NJ 322 ECJ	M, ML, P
	240	50	530	540	61	3 000	3 400	10,5	▶ NU 322 ECP	J, M, ML
	240	50	530	540	61	3 000	3 400	10,5	▶ NUP 322 ECP	J, M, ML
	240	80	780	900	102	3 000	3 400	17	▶ NJ 2322 ECP	ML
	240	80	780	900	102	3 000	3 400	17	▶ NU 2322 ECP	ML
	240	80	780	900	102	3 000	3 400	17,5	▶ NUP 2322 ECP	ML
280	65	550	630	69,5	2 600	3 200	22,5	▶ NJ 422 M	–	
120	180	28	134	183	20,8	4 000	6 300	2,55	▶ NU 1024 ML	M
	215	40	390	430	49	3 400	3 600	5,75	▶ N 224 ECP	M
	215	40	390	430	49	3 400	3 600	5,75	▶ NU 224 ECP	J, M, ML
	215	40	390	430	49	3 400	3 600	5,85	▶ NJ 224 ECP	J, M, ML
	215	40	390	430	49	3 400	3 600	5,95	▶ NUP 224 ECJ	M, ML, P
	215	58	520	630	72	3 400	3 600	8,2	▶ NU 2224 ECP	J, M, ML
	215	58	520	630	72	3 400	3 600	8,65	▶ NJ 2224 ECJ	M, ML, P
	215	58	520	630	72	3 400	3 600	8,65	▶ NUP 2224 ECP	J, M, ML
	260	55	610	620	69,5	2 800	3 200	13	▶ N 324 ECP	M
	260	55	610	620	69,5	2 800	3 200	13	▶ NU 324 ECP	J, M, ML
	260	55	610	620	69,5	2 800	3 200	13,5	▶ NJ 324 ECJ	M, ML, P
	260	55	610	620	69,5	2 800	3 200	14	▶ NUP 324 ECP	J, M, ML
	260	86	915	1 040	116	2 800	5 000	22,5	▶ NU 2324 ECML	M
	260	86	915	1 040	116	2 800	5 000	23	▶ NJ 2324 ECML	M
	260	86	915	1 040	116	2 800	5 000	23,5	▶ NUP 2324 ECML	M
310	72	644	735	78	2 400	2 800	27,5	▶ NU 424	M	

6.1



SKF Explorer bearing

▶ Popular item

¹⁾ When ordering bearings with an alternative standard cage the suffix of the standard cage has to be replaced by the suffix of the alternative cage.

For example NU .. ECP becomes NU .. ECML (for permissible speed → page 511).

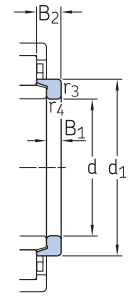
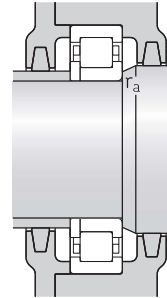
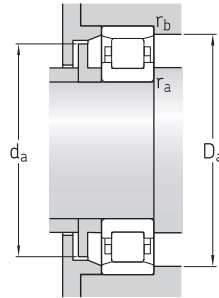
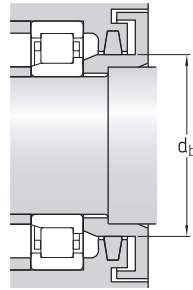
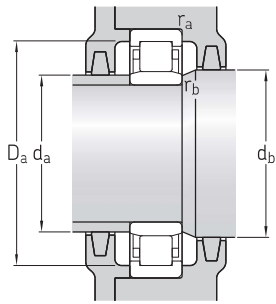

Angle ring

Dimensions				Abutment and fillet dimensions								Calculation factor k_r	Angle ring Designation	Mass	Dimensions		
d	d_1	D_1	F, E	$r_{1,2}$	$r_{3,4}$	s	d_a	d_a	d_b, D_a	D_a	r_a				r_b	B_1	B_2
mm	mm	mm	mm	mm	mm	mm	mm	mm	mm	mm	mm	mm	mm	mm			
110	-	149,7	125	2	1,1	3,8	116	122	128	160	2	1	0,15	-	-	-	
	-	172,5	132,5	2,1	2,1	2,1	122	129	135	187	2	2	0,15	HJ 222 EC	0,62	11	17
	141	-	180,5	2,1	2,1	2,1	122	129	177	184	2	2	0,12	-	-	-	
	141	172,5	132,5	2,1	2,1	2,1	122	129	144	187	2	-	0,15	HJ 222 EC	0,62	11	17
	141	172,5	132,5	2,1	2,1	-	122	-	144	187	2	-	0,15	-	-	-	
	141	172,5	132,5	2,1	2,1	3,7	122	129	144	187	2	-	0,2	-	-	-	
	-	172,5	132,5	2,1	2,1	3,7	122	129	135	187	2	2	0,2	-	-	-	
	141	172,5	132,5	2,1	2,1	-	122	-	144	187	2	-	0,2	-	-	-	
	155	-	211	3	3	3	124	208	215	225	2,5	2,5	0,12	-	-	-	
	155	200	143	3	3	3	124	139	159	225,2	2,5	-	0,15	HJ 322 EC	1,2	14	22
	-	200	143	3	3	3	124	139	146	225,2	2,5	2,5	0,15	HJ 322 EC	1,2	14	22
	155	200	143	3	3	-	124	-	159	225,2	2,5	-	0,15	-	-	-	
	155	200	143	3	3	7,5	124	139	159	225,2	2,5	-	0,25	HJ 2322 EC	1,25	14	26,5
	-	200	143	3	3	7,5	124	139	146	225,2	2,5	2,5	0,25	HJ 2322 EC	1,25	14	26,5
	155	200	143	3	3	-	124	-	159	225,2	2,5	-	0,25	-	-	-	
171	219,65	155	4	4	4,8	131	151	175	260	3	-	0,15	HJ 422	2,1	17	29,5	
120	-	159,7	135	2	1,1	3,8	126	133	138	171	2	1	0,15	-	-	-	
	153	-	195,5	2,1	2,1	1,9	132	192	199	203	2	2	0,12	-	-	-	
	-	186,55	143,5	2,1	2,1	1,9	132	140	146	201,6	2	2	0,15	HJ 224 EC	0,71	11	17
	153	186,55	143,5	2,1	2,1	1,9	132	140	156	201,6	2	-	0,15	HJ 224 EC	0,71	11	17
	153	186,55	143,5	2,1	2,1	-	132	-	156	201,6	2	-	0,15	-	-	-	
	-	186,9	143,5	2,1	2,1	3,8	132	140	146	201,6	2	2	0,2	HJ 2224 EC	0,73	11	20
	153	186,9	143,5	2,1	2,1	3,8	132	140	156	201,6	2	-	0,2	HJ 2224 EC	0,73	11	20
	153	186,9	143,5	2,1	2,1	-	132	-	156	201,6	2	-	0,2	-	-	-	
	168	-	230	3	3	3,7	134	226	235	245	2,5	2,5	0,12	-	-	-	
	-	217,8	154	3	3	3,7	134	150	157	244,8	2,5	2,5	0,15	HJ 324 EC	1,4	14	22,5
	168	217,8	154	3	3	3,7	134	150	171	244,8	2,5	-	0,15	HJ 324 EC	1,4	14	22,5
	168	217,8	154	3	3	-	134	-	171	244,8	2,5	-	0,15	-	-	-	
	-	218,7	154	3	3	7,2	134	150	157	244,8	2,5	2,5	0,38	HJ 2324 EC	1,45	14	26
	168	218,7	154	3	3	7,2	134	150	171	244,8	2,5	-	0,38	HJ 2324 EC	1,45	14	26
	168	218,7	154	3	3	-	134	-	171	244,8	2,5	-	0,38	-	-	-	
-	238,5	170	5	5	6,3	144	165	173	286	4	4	0,15	HJ 424	2,6	17	30,5	



6.1 Single row cylindrical roller bearings

d 130 – 150 mm

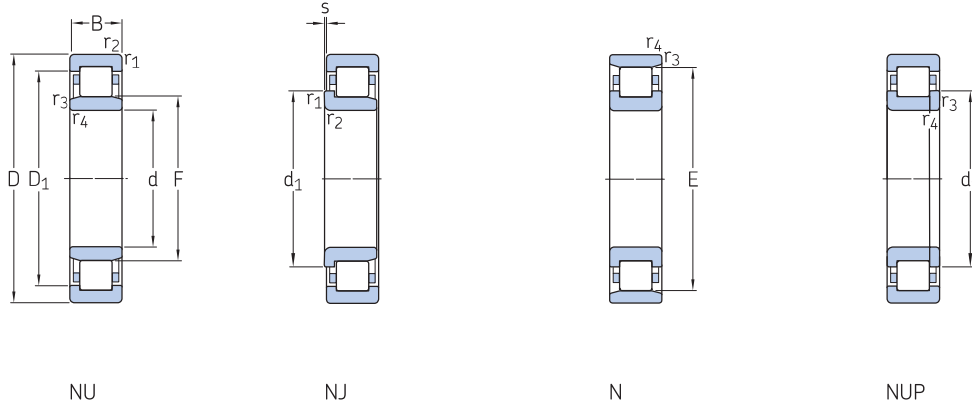

6.1

Principal dimensions			Basic load ratings		Fatigue load limit	Speed ratings		Mass	Designations Bearing with standard cage	Alternative standard cage ¹⁾	
d	D	B	C	C ₀		Reference speed	Limiting speed				
mm			kN		kN	r/min		kg	–		
130	200	33	165	224	25	3 800	5 600	3,85	▶ NU 1026 ML	M	
	200	33	165	224	25	3 800	5 600	3,9	▶ NJ 1026 ML	M, ML, P	
	230	40	415	455	51	3 200	3 400	6,45	▶ N 226 ECP	–	
	230	40	415	455	51	3 200	3 400	6,45	▶ NU 226 ECP	J, M, ML	
	230	40	415	455	51	3 200	3 400	6,5	▶ NUP 226 ECJ	M, ML, P	
	230	40	415	455	51	3 200	3 400	6,6	▶ NJ 226 ECP	J, M, ML	
	230	64	610	735	83	3 200	3 400	10	▶ NU 2226 ECP	ML	
	230	64	610	735	83	3 200	3 400	10,5	▶ NUP 2226 ECP	–	
	230	64	610	735	83	3 200	5 300	12	▶ NJ 2226 ECML	P	
	280	58	720	750	81,5	2 400	3 000	16	▶ NU 326 ECP	J, M, ML	
	280	58	720	750	81,5	2 400	3 000	16,5	▶ NJ 326 ECJ	M, ML, P	
	280	58	720	750	81,5	2 400	3 000	18	▶ N 326 ECM	P	
	280	58	720	750	81,5	2 400	3 000	19,5	▶ NUP 326 ECP	J, M, ML	
	280	93	1 060	1 250	137	2 400	4 500	28,5	▶ NU 2326 ECML	PA	
	280	93	1 060	1 250	137	2 400	4 500	29,5	▶ NJ 2326 ECML	PA	
	280	93	1 060	1 250	137	2 400	4 500	29,5	▶ NUP 2326 ECML	–	
140	210	33	179	255	28	3 600	5 300	4,05	▶ NU 1028 ML	M	
	250	42	450	510	57	2 800	3 200	8,45	▶ NUP 228 ECJ	M, ML	
	250	42	450	510	57	2 800	3 200	8,6	▶ NJ 228 ECJ	M, ML	
	250	42	450	510	57	2 800	3 200	9,4	▶ NU 228 ECM	J, ML	
	250	68	655	830	93	2 800	4 800	15	▶ NU 2228 ECML	PA	
	250	68	655	830	93	2 800	4 800	15,5	▶ NJ 2228 ECML	PA	
	250	68	655	830	93	2 800	4 800	15,5	▶ NUP 2228 ECML	–	
	300	62	780	830	88	2 400	2 800	20	▶ NJ 328 ECJ	M, ML	
	300	62	780	830	88	2 400	2 800	22,5	▶ NU 328 ECM	J, ML	
	300	62	780	830	88	2 400	2 800	23,5	▶ NUP 328 ECM	–	
	300	102	1 200	1 430	150	2 400	4 300	36	▶ NU 2328 ECML	–	
	300	102	1 200	1 430	150	2 400	4 300	36,5	▶ NJ 2328 ECML	–	
	300	102	1 200	1 430	150	2 400	4 300	37	▶ NUP 2328 ECML	–	
	150	225	35	198	290	31,5	3 200	5 000	4,9	▶ NU 1030 ML	M
		270	45	510	600	64	2 600	2 800	10,5	▶ NUP 230 ECJ	M, ML
270		45	510	600	64	2 600	2 800	11,5	▶ NU 230 ECM	J, ML	

SKF Explorer bearing

▶ Popular item

¹⁾ When ordering bearings with an alternative standard cage the suffix of the standard cage has to be replaced by the suffix of the alternative cage.

For example NU .. ECP becomes NU .. ECML (for permissible speed → [page 511](#)).

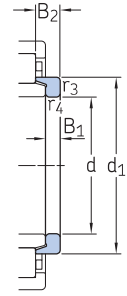
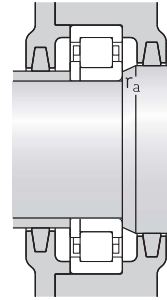
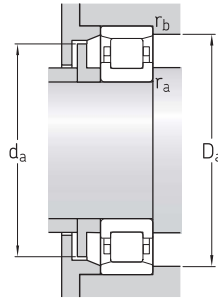
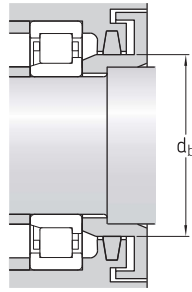
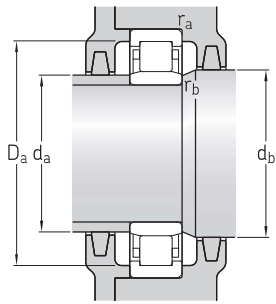

Angle ring

Dimensions				Abutment and fillet dimensions									Calculation factor k_r	Angle ring Designation	Mass	Dimensions		
d	d_1	D_1	F, E	$r_{1,2}$ min.	$r_{3,4}$ min.	s max.	d_a min.	d_a max.	d_b, D_a min.	D_a max.	r_a max.	r_b max.				B_1	B_2	
mm														-	-	kg	mm	
130	-	175,2	148	2	1,1	4,7	137	145	151	191	2	1	0,15	-	-	-	-	
	154	175,2	148	2	1,1	4,7	137	145	158	191	2	1	0,15	-	-	-	-	
	164	-	209,5	3	3	2,1	144	206	213	217	2,5	2,5	0,12	-	-	-	-	
	-	200,3	153,5	3	3	2,1	144	150	157	215,4	2,5	2,5	0,15	HJ 226 EC	0,75	11	17	
	164	200,3	153,5	3	3	-	144	-	167	215,4	2,5	-	0,15	-	-	-	-	
	164	200,3	153,5	3	3	2,1	144	150	167	215,4	2,5	-	0,15	HJ 226 EC	0,75	11	17	
	-	200,3	153,5	3	3	4,3	144	150	157	215,4	2,5	2,5	0,2	HJ 2226 EC	0,83	11	21	
	164	200,3	153,5	3	3	-	144	-	167	215,4	2,5	-	0,2	-	-	-	-	
	164	201,2	153,5	3	3	4,3	144	150	167	215,4	2,5	-	0,3	HJ 2226 EC	0,83	11	21	
	-	234,2	167	4	4	3,7	147	163	170	261,4	3	3	0,15	HJ 326 EC	1,65	14	23	
	181	234,2	167	4	4	3,7	147	163	184	261,4	3	-	0,15	HJ 326 EC	1,65	14	23	
	181	-	247	4	4	3,7	147	243	251	262	3	3	0,12	-	-	-	-	
181	234,2	167	4	4	-	147	-	184	261,4	3	-	0,15	-	-	-	-		
-	235,2	167	4	4	8,7	147	163	170	261,4	3	3	0,38	HJ 2326 EC	1,6	14	28		
181	235,2	167	4	4	8,7	147	163	184	261,4	3	-	0,38	HJ 2326 EC	1,6	14	28		
181	235,2	167	4	4	-	147	-	184	261,4	3	-	0,38	-	-	-	-		
140	-	184,2	158	2	1,1	4,4	147	155	161	201	2	1	0,15	-	-	-	-	
	179	215,78	169	3	3	-	154	-	182	235	2,5	-	0,15	-	-	-	-	
	179	215,78	169	3	3	2,5	154	165	182	235	2,5	-	0,15	HJ 228 EC	0,97	11	18	
	-	215,78	169	3	3	2,5	154	165	172	235	2,5	2,5	0,15	HJ 228 EC	0,97	11	18	
	-	216,7	169	3	3	4,4	154	165	172	235	2,5	2,5	0,3	HJ 2228 EC	1,05	11	23	
	179	216,7	169	3	3	4,4	154	165	182	235	2,5	-	0,3	HJ 2228 EC	1,05	11	23	
	179	216,7	169	3	3	-	154	-	182	235	2,5	-	0,3	-	-	-	-	
	195	250,6	180	4	4	3,7	157	175	199	282,5	3	-	0,15	HJ 328 EC	2,05	15	25	
	-	250,6	180	4	4	3,7	157	175	183	282,5	3	3	0,15	HJ 328 EC	2,05	15	25	
	195	250,6	180	4	4	-	157	-	199	282,5	3	-	0,15	-	-	-	-	
	-	251,7	180	4	4	9,7	157	175	183	282,5	3	3	0,38	HJ 2328 EC	2,15	15	31	
	195	251,7	180	4	4	9,7	157	175	199	282,5	3	-	0,38	HJ 2328 EC	2,15	15	31	
195	251,7	180	4	4	-	157	-	199	282,5	3	-	0,38	-	-	-	-		
150	-	199,05	169,5	2,1	1,5	4,9	158	167	173	215	2	1,5	0,15	-	-	-	-	
	193	232,2	182	3	3	-	164	-	196	254,6	2,5	-	0,15	-	-	-	-	
	-	232,2	182	3	3	2,5	164	178	186	254,6	2,5	2,5	0,15	HJ 230 EC	1,25	12	19,5	



6.1 Single row cylindrical roller bearings

d 150 – 180 mm

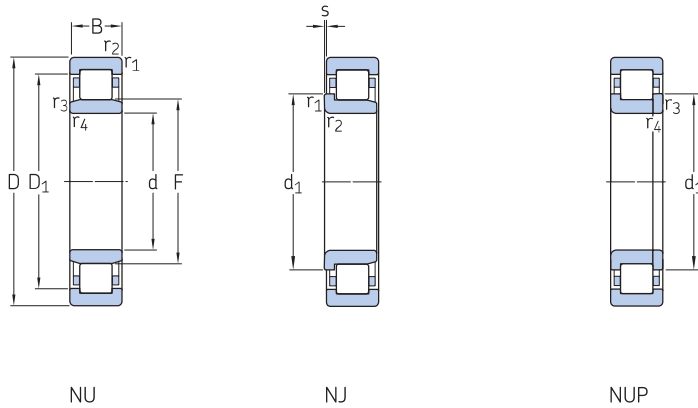

6.1

Principal dimensions			Basic load ratings		Fatigue load limit	Speed ratings		Mass	Designations Bearing with standard cage	Alternative standard cage ¹⁾	
d	D	B	C	C ₀		Reference speed	Limiting speed				
mm			kN		kN	r/min		kg	–		
150 cont.	270	45	510	600	64	2 600	2 800	12	▶ NJ 230 ECM	J, ML	
	270	73	735	930	100	2 600	2 800	18,5	▶ NU 2230 ECM	ML	
	270	73	735	930	100	2 600	2 800	19	▶ NJ 2230 ECM	ML	
	320	65	900	965	100	2 200	2 600	26,5	▶ NU 330 ECM	ML	
	320	65	900	965	100	2 200	4 000	26,5	▶ NJ 330 ECML	M	
	320	108	1 370	1 630	170	2 200	4 000	42,5	▶ NU 2330 ECML	–	
	320	108	1 370	1 630	170	2 200	4 000	43	▶ NJ 2330 ECML	–	
	160	240	38	229	325	35,5	3 000	4 800	6	▶ NU 1032 ML	M
		290	48	585	680	72	2 400	2 600	14	▶ NU 232 ECM	ML
		290	48	585	680	72	2 400	2 600	15,5	▶ NUP 232 ECM	–
290		48	585	680	72	2 400	4 000	14,5	▶ NJ 232 ECML	M	
290		80	930	1 200	129	2 400	4 000	23	▶ NU 2232 ECML	M	
290		80	930	1 200	129	2 400	4 000	23,5	▶ NJ 2232 ECML	M	
340		68	1 000	1 080	112	2 000	3 600	31	▶ NJ 332 ECML	M	
340		68	1 000	1 080	112	2 000	3 600	31	▶ NU 332 ECML	M	
340		114	1 250	1 730	173	1 800	3 600	50	▶ NU 2332 ECML	–	
340		114	1 250	1 730	173	1 800	3 600	50,5	▶ NJ 2332 ECML	–	
170	260	42	275	400	41,5	2 800	4 300	8	▶ NU 1034 ML	M	
	260	42	275	400	41,5	2 800	4 300	8,2	▶ NJ 1034 ML	M	
	310	52	695	815	85	2 200	3 800	17,5	▶ NJ 234 ECML	M	
	310	52	695	815	85	2 200	3 800	17,5	▶ NU 234 ECML	M	
	310	86	1 060	1 340	140	2 200	3 800	28	▶ NU 2234 ECML	–	
	310	86	1 060	1 340	140	2 200	3 800	29	▶ NJ 2234 ECML	–	
	360	72	952	1 180	116	1 700	2 200	33	▶ NU 334 ECM	–	
	360	120	1 450	2 040	204	1 700	3 400	60,5	▶ NJ 2334 ECML	–	
	360	120	1 450	2 040	204	1 700	3 400	60,5	▶ NU 2334 ECML	–	
	180	280	46	336	475	51	2 600	4 000	10,5	▶ NJ 1036 ML	M
280		46	336	475	51	2 600	4 000	10,5	▶ NU 1036 ML	M	
320		52	720	850	88	2 200	3 600	18,5	▶ NJ 236 ECML	M	
320		52	720	850	88	2 200	3 600	18,5	▶ NU 236 ECML	M	
320		86	1 100	1 430	146	2 200	3 600	30	▶ NJ 2236 ECML	M	
320		86	1 100	1 430	146	2 200	3 600	30	▶ NU 2236 ECML	M	

SKF Explorer bearing

▶ Popular item

¹⁾ When ordering bearings with an alternative standard cage the suffix of the standard cage has to be replaced by the suffix of the alternative cage.

For example NU .. ECP becomes NU .. ECML (for permissible speed → [page 511](#)).

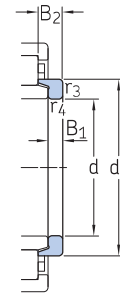
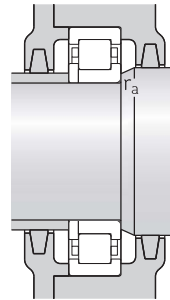
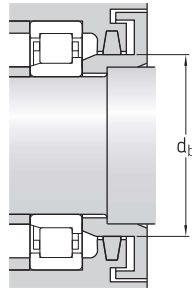
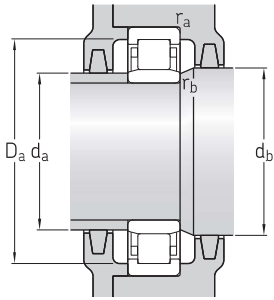

Angle ring

Dimensions				Abutment and fillet dimensions										Calculation factor k_r	Angle ring Designation	Mass	Dimensions	
d	d_1	D_1	F, E	$r_{1,2}$	$r_{3,4}$	s	d_a	d_a	d_b, D_a	D_a	r_a	r_b	B_1				B_2	
mm	\approx	\approx		min.	min.	max.	min.	max.	min.	max.	max.	max.			kg	mm		
150 cont.	193	232,2	182	3	3	2,5	164	178	196	254,6	2,5	–	0,15	HJ 230 EC	1,25	12	19,5	
	–	232,2	182	3	3	4,9	164	178	186	254,6	2,5	2,5	0,2	HJ 2230 EC	1,35	12	24,5	
	194	232,2	182	3	3	4,9	164	178	197	254,6	2,5	–	0,2	HJ 2230 EC	1,35	12	24,5	
–	209	268,7	193	4	4	4	167	188	196	302,2	3	3	0,15	HJ 330 EC	2,3	15	25	
	–	269,8	193	4	4	4	167	188	213	302,2	3	–	0,23	HJ 330 EC	2,3	15	25	
	–	269,8	193	4	4	10,5	167	188	196	302,2	3	3	0,38	–	–	–	–	
–	209	269,8	193	4	4	10,5	167	188	213	302,2	3	–	0,38	–	–	–	–	
	160	–	210,8	180	2,1	1,5	5,2	167	177	183	230	2	1,5	0,15	HJ 1032	0,72	10	19
		–	248,6	195	3	3	2,7	175	191	198	274,2	2,5	2,5	0,15	HJ 232 EC	1,5	12	20
206		248,6	195	3	3	–	175	–	210	274,2	2,5	–	0,15	–	–	–	–	
–	206	249,6	195	3	3	2,7	175	191	210	274,2	2,5	–	0,23	HJ 232 EC	1,5	12	20	
	–	251,1	193	3	3	4,5	174	189	196	274,2	2,5	2,5	0,3	HJ 2232 EC	1,55	12	24,5	
	205	251,1	193	3	3	4,5	174	189	209	274,2	2,5	–	0,3	HJ 2232 EC	1,55	12	24,5	
–	221	286	204	4	4	4	177	199	225	321,9	3	–	0,23	HJ 332 EC	2,6	15	25	
	–	286	204	4	4	4	177	199	207	321,9	3	3	0,23	HJ 332 EC	2,6	15	25	
	–	286	204	4	4	11	177	199	207	321,9	3	3	0,38	–	–	–	–	
–	221	286	204	4	4	11	177	199	225	321,9	3	–	0,38	–	–	–	–	
	170	–	226,9	193	2,1	2,1	5,8	180	189	197	250	2	2	0,15	HJ 1034	0,93	11	21
		201	226,9	193	2,1	2,1	5,8	180	189	206	250	2	–	0,15	HJ 1034	0,93	11	21
220		268,5	207	4	4	2,9	188	203	224	292,4	3	–	0,23	HJ 234 EC	1,65	12	20	
–	–	268,5	207	4	4	2,9	188	203	210	292,4	3	3	0,23	HJ 234 EC	1,65	12	20	
	–	269,9	205	4	4	4,2	187	201	208	292,4	3	3	0,3	HJ 2234 EC	1,8	12	24	
	220	269,9	205	4	4	4,2	187	201	226	292	3	–	0,3	HJ 2234 EC	1,8	12	24	
–	234	300,45	218	4	4	4,6	187	213	221	341,6	3	3	0,15	–	–	–	–	
	–	300,2	216	4	4	10	186	211	238	341,6	3	–	0,38	–	–	–	–	
	–	300,2	216	4	4	10	186	211	219	341,6	3	3	0,38	–	–	–	–	
180	215	246,1	205	2,1	2,1	6,1	190	202	218	270	2	–	0,15	–	–	–	–	
	–	246,1	205	2,1	2,1	6,1	190	202	208	270	2	2	0,15	HJ 1036	1,25	12	22,5	
	230	278,6	217	4	4	2,9	198	213	234	302,2	3	–	0,23	HJ 236 EC	1,7	12	20	
–	–	278,6	217	4	4	2,9	198	213	220	302,2	3	3	0,23	HJ 236 EC	1,7	12	20	
	229	280	215	4	4	4,2	197	211	233	302,2	3	–	0,3	HJ 2236 EC	1,9	12	24	
	–	280	215	4	4	4,2	197	211	218	302,2	3	3	0,3	HJ 2236 EC	1,9	12	24	



6.1 Single row cylindrical roller bearings

d 180 – 220 mm

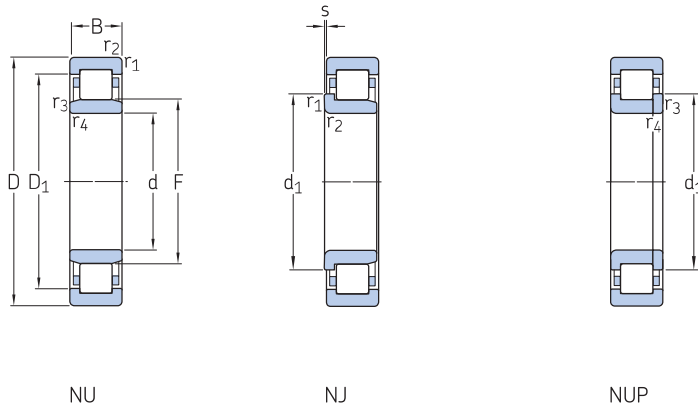

6.1

Principal dimensions			Basic load ratings		Fatigue load limit	Speed ratings		Mass	Designations Bearing with standard cage	Alternative standard cage ¹⁾
d	D	B	dynamic C	static C ₀		Reference speed	Limiting speed			
mm			kN		kN	r/min		kg	–	
180 cont.	380	75	1 020	1 290	125	1 600	2 200	42,5	▶ NU 336 ECM	–
	380	75	1 020	1 290	125	1 600	2 200	44	▶ NJ 336 ECM	–
	380	126	1 610	2 240	216	1 600	3 200	69,5	▶ NU 2336 ECML	–
	380	126	1 610	2 240	216	1 600	3 200	70,5	▶ NJ 2336 ECML	–
190	290	46	347	500	53	2 600	3 800	11	▶ NJ 1038 ML	M
	290	46	347	500	53	2 600	3 800	11	▶ NU 1038 ML	M
	340	55	800	965	98	2 000	3 400	22	▶ NJ 238 ECML	M
	340	55	800	965	98	2 000	3 400	22,5	▶ NU 238 ECML	M
	340	55	800	965	98	2 000	3 400	22,5	▶ NUP 238 ECML	M
	340	92	1 220	1 600	160	2 000	3 400	35,5	▶ NU 2338 ECML	M
	340	92	1 220	1 600	160	2 000	3 400	37	▶ NJ 2338 ECML	M
	400	78	1 140	1 500	143	1 500	2 000	50	▶ NU 338 ECM	–
	400	132	1 830	2 550	236	1 500	3 000	80,5	▶ NU 2338 ECML	–
	400	132	1 830	2 550	236	1 500	3 000	82	▶ NJ 2338 ECML	–
200	310	51	380	570	58,5	2 400	3 600	14	▶ NU 1040 ML	M
	360	58	880	1 060	106	1 900	3 200	26,5	▶ NU 240 ECML	M
	360	58	880	1 060	106	1 900	3 200	27	▶ NJ 240 ECML	M
	360	98	1 370	1 800	180	1 900	3 200	44	▶ NJ 2240 ECML	–
	360	98	1 370	1 800	180	1 900	3 200	44	▶ NU 2240 ECML	–
	420	80	1 230	1 630	150	1 400	2 800	56,5	▶ NJ 340 ECML	–
	420	80	1 230	1 630	150	1 400	2 800	57	▶ NU 340 ECML	–
	420	138	1 980	2 800	255	1 400	2 800	92,5	▶ NU 2340 ECML	–
	420	138	1 980	2 800	255	1 400	2 800	94	▶ NJ 2340 ECML	–
	420	138	1 980	2 800	255	1 400	2 800	94	▶ NU 2340 ECML	–
220	340	56	495	735	73,5	2 200	3 200	18,5	▶ NJ 1044 ML	M
	340	56	495	735	73,5	2 200	3 200	18,5	▶ NU 1044 ML	–
	400	65	1 060	1 290	125	1 700	3 000	37	▶ NJ 244 ECML	M
	400	65	1 060	1 290	125	1 700	3 000	37	▶ NU 244 ECML	M
	400	65	1 060	1 290	125	1 700	3 000	37,5	▶ NUP 244 ECML	M
	400	108	1 570	2 280	212	1 600	3 000	58	▶ NU 2244 ECML	–
	400	108	1 570	2 280	212	1 600	3 000	60	▶ NJ 2244 ECML	–
	460	88	1 210	1 630	150	1 500	1 700	73,5	▶ NJ 344 M	–
	460	88	1 210	1 630	150	1 500	1 700	75	▶ NU 344 M	–
	460	145	2 380	3 450	310	1 300	2 600	118	▶ NU 2344 ECML	–

SKF Explorer bearing

▶ Popular item

¹⁾ When ordering bearings with an alternative standard cage the suffix of the standard cage has to be replaced by the suffix of the alternative cage.

For example NU .. ECP becomes NU .. ECML (for permissible speed → [page 511](#)).

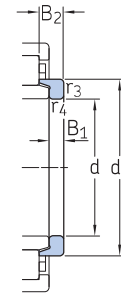
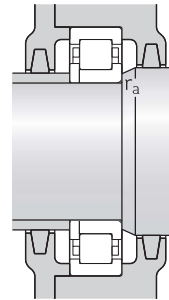
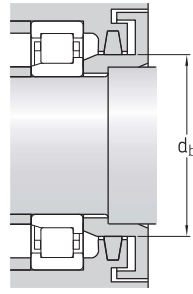
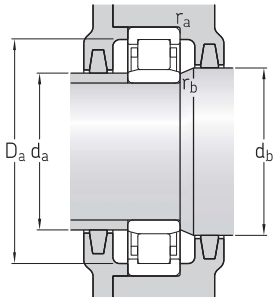

Angle ring

Dimensions				Abutment and fillet dimensions										Calculation factor k_r	Angle ring Designation	Mass	Dimensions	
d	d_1	D_1	F, E	$r_{1,2}$	$r_{3,4}$	s	d_a	d_a	d_b, D_a	D_a	r_a	r_b	k_r				Designation	Mass
mm	mm	mm	mm	mm	mm	mm	mm	mm	mm	mm	mm	mm	mm	mm	kg	mm	mm	
180	–	318,6	231	4	4	4,2	197	226	234	361,3	3	3	0,15	–	–	–	–	
	cont.	250	318,6	231	4	4	4,2	197	226	254,5	361	3	–	0,15	–	–	–	
	–	321,4	227	4	4	10,5	196	222	230	361,3	3	3	0,38	–	–	–	–	
	248	321,4	227	4	4	10,5	196	222	252	361	3	–	0,38	–	–	–	–	
190	225	256,1	215	2,1	2,1	6,1	200	212	231	280	2	–	0,15	HJ 1038	1,35	12	22,5	
	–	256,1	215	2,1	2,1	6,1	200	212	219	280	2	2	0,15	HJ 1038	1,35	12	22,5	
	244	295	230	4	4	3	207	226	248	321,9	3	–	0,23	HJ 238 EC	2,2	13	21,5	
	–	295	230	4	4	3	207	226	233	321,9	3	3	0,23	HJ 238 EC	2,2	13	21,5	
	244	295	230	4	4	–	207	–	248	321,9	3	–	0,23	–	–	–	–	
	–	296,4	228	4	4	5	207	224	231	321,9	3	3	0,3	–	–	–	–	
	243	296,4	228	4	4	5	207	224	247	322	3	–	0,3	–	–	–	–	
	–	336,3	245	5	5	4,3	210	240	249	380	4	4	0,15	HJ 338 EC	4,3	18	29	
	–	342,75	240	5	5	9,5	209	234	244	380	4	4	0,38	–	–	–	–	
	262	342,75	240	5	5	9,5	209	234	266	378	4	–	0,38	–	–	–	–	
200	–	269	229	2,1	2,1	7	211	225	234	300	2	2	0,15	HJ 1040	1,65	13	25,5	
	–	311,5	243	4	4	2,6	217	238	247	341,6	3	3	0,23	HJ 240 EC	2,55	14	23	
	258	311,5	243	4	4	2,6	217	238	262	341,6	3	–	0,23	HJ 240 EC	2,55	14	23	
	256	312,9	241	4	4	5,1	217	236	260	342	3	–	0,3	–	–	–	–	
	–	312,9	241	4	4	5,1	217	236	245	341,6	3	3	0,3	–	–	–	–	
	278	352,4	258	5	5	6	220	253	282	400	4	–	0,23	–	–	–	–	
	–	352,4	258	5	5	6	220	253	262	399,8	4	4	0,23	–	–	–	–	
	–	357,6	253	5	5	9,4	220	247	257	399,8	4	4	0,38	–	–	–	–	
	278	357,6	253	5	5	9,4	220	247	282	399,8	4	–	0,38	–	–	–	–	
	220	262	296,2	250	3	3	7,5	233	246	266	328	2,5	–	0,15	HJ 1044	2,15	14	27
–		296,2	250	3	3	7,5	233	246	254	328	2,5	2,5	0,15	HJ 1044	2,15	14	27	
284		343,7	268	4	4	2,3	238	263	288	383	3	–	0,23	HJ 244 EC	3,25	15	25	
–		343,7	268	4	4	2,3	238	263	272	383	3	3	0,23	HJ 244 EC	3,25	15	25	
284		343,7	268	4	4	–	238	–	288	383	3	–	0,23	–	–	–	–	
–		350	259	4	4	7,9	237	254	263	383	3	3	0,3	–	–	–	–	
278		350	259	4	4	7,9	237	254	282	383	3	–	0,3	–	–	–	–	
307		371	284	5	5	5,2	240	277	311	440	4	–	0,15	–	–	–	–	
–		371	284	5	5	5,2	240	277	288	440	4	4	0,15	–	–	–	–	
–		391	277	5	5	10,4	238	272	272	442	4	4	0,1	–	–	–	–	

6.1 Single row cylindrical roller bearings

d 240 – 300 mm

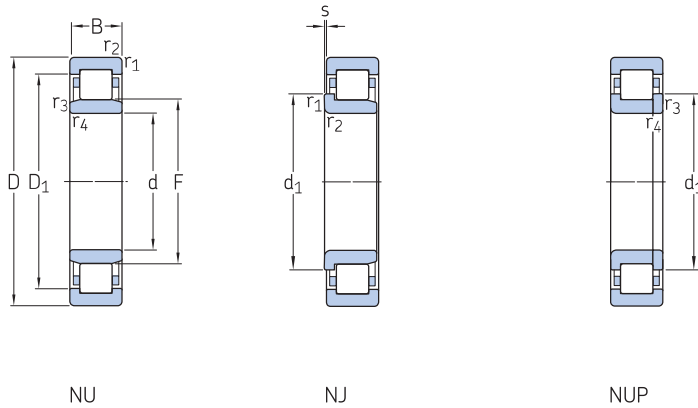

Principal dimensions			Basic load ratings		Fatigue load limit	Speed ratings		Mass	Designations Bearing with standard cage	Alternative standard cage ¹⁾
d	D	B	C	C ₀		Reference speed	Limiting speed			
mm			kN		kN	r/min		kg	–	
240	360	56	523	800	78	2 000	3 000	19,5	▶ NU 1048 ML	M
	440	72	952	1 370	129	1 600	2 200	51,5	▶ NU 248 MA	–
	440	72	952	1 370	129	1 600	2 200	53	▶ NJ 248 MA	–
	440	72	952	1 370	129	1 600	2 200	53	NUP 248 MA	–
	440	120	1 450	2 360	216	1 500	2 200	84	▶ NU 2248 MA	–
	440	120	1 450	2 360	224	1 500	2 200	86	▶ NJ 2248 MA	–
	500	95	1 450	2 000	180	1 300	2 000	94,5	NU 348 MA	–
	500	95	1 450	2 000	180	1 300	2 000	98,5	NJ 348 MA	–
	500	155	2 750	4 000	345	1 200	2 400	137	▶ NU 2348 ECML	–
	260	400	65	627	965	96,5	1 800	2 800	29,5	▶ NU 1052 ML
400		65	627	965	96,5	1 800	2 800	30	NJ 1052 ML	M
480		80	1 170	1 700	150	1 400	2 000	68,5	▶ NU 252 MA	–
480		80	1 170	1 700	150	1 400	2 000	69	▶ NJ 252 MA	–
480		80	1 170	1 700	150	1 400	2 000	72	NUP 252 MA	–
480		130	1 790	3 000	265	1 300	2 000	112	NJ 2252 MA	–
480		130	1 790	3 000	265	1 400	2 000	110	▶ NU 2252 MA	–
540		102	1 940	2 700	236	1 100	1 800	121	NU 352 ECMA	–
540		165	3 140	4 550	400	1 100	1 900	196	NJ 2352 ECMA	–
540		165	3 190	4 550	400	1 100	1 800	193	NU 2352 ECMA	–
280	420	65	660	1 060	102	1 700	2 600	31	▶ NU 1056 ML	M
	460	146	2 290	3 900	335	1 200	2 000	101	NU 3156 ECMA	–
	500	80	1 140	1 800	156	1 400	1 900	73	NJ 256 MA	–
	500	80	1 190	1 800	156	1 400	1 900	71,5	▶ NU 256 MA	–
	500	130	2 330	3 750	320	1 200	2 200	115	▶ NU 2256 ECML	–
	580	175	2 700	4 300	365	1 000	1 700	230	NU 2356 MA	–
	580	175	2 700	4 300	365	1 000	1 700	230	NU 2356 MA	–
300	460	74	858	1 370	129	1 500	2 000	46	NJ 1060 MA	–
	460	74	858	1 370	129	1 500	2 000	46	▶ NU 1060 MA	–
	460	95	1 510	2 600	245	1 300	2 000	62	NU 2060 ECMA	–
	540	85	1 420	2 120	183	1 300	1 400	89,5	▶ NU 260 M	–
	540	140	2 090	3 450	300	1 200	1 800	145	NU 2260 MA	–
	620	109	2 330	3 350	280	950	1 200	174	NU 360 ECM	–
	620	185	4 020	5 850	480	950	1 600	270	NU 2360 ECMA	–

▶ Popular item

¹⁾ When ordering bearings with an alternative standard cage the suffix of the standard cage has to be replaced by the suffix of the alternative cage.

For example NU .. ECP becomes NU .. ECML (for permissible speed → [page 511](#)).

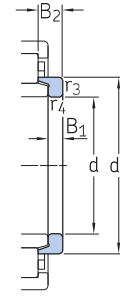
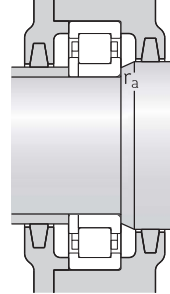
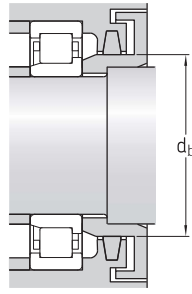
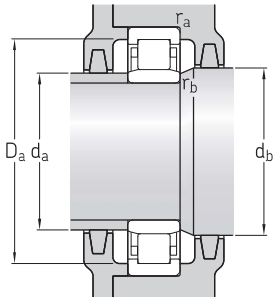

Angle ring

Dimensions				Abutment and fillet dimensions										Calculation factor k_r	Angle ring Designation	Mass	Dimensions	
d	d_1	D_1	F, E	$r_{1,2}$	$r_{3,4}$	s	d_a	d_a	d_b, D_a	D_a	r_a	r_b	B_1				B_2	
mm	\approx	\approx		min.	min.	max.	min.	max.	min.	max.	max.	max.			kg	mm		
240	-	316,2	270	3	3	7,5	252	266	274	348	2,5	2,5	0,15	HJ 1048	2,25	14	27	
	-	365	295	4	4	3,4	257	288	299	423	3	3	0,15	-	-	-	-	
	313	365	295	4	4	3,4	257	288	317	423	3	-	0,15	-	-	-	-	
	-	365	295	4	4	-	257	-	316	423	3	-	0,15	-	-	-	-	
	-	365	295	4	4	4,3	257	284	299	423	3	3	0,2	-	-	-	-	
	313	365	295	4	4	4,3	257	284	317	423	3	-	0,2	-	-	-	-	
	-	410	310	5	5	5	258	305	314	482	4	4	0,1	-	-	-	-	
	322	403	310	5	5	5,6	260	302	339	480	4	-	0,15	-	-	-	-	
	-	425	299	5	5	1,5	258	294	314	482	4	4	0,38	-	-	-	-	
	260	-	353,1	296	4	4	8	275	292	300	385	3	3	0,15	HJ 1052	3,4	16	31,5
309		353,1	296	4	4	8	275	292	313	385	3	-	0,15	HJ 1052	3,4	16	31,5	
-		397	320	5	5	3,4	280	313	324	460	4	4	0,15	-	-	-	-	
340		397	320	5	5	3,4	280	313	344	460	4	-	0,15	-	-	-	-	
340		397	320	5	5	-	280	-	344	460	4	-	0,23	-	-	-	-	
340		397	320	5	5	4,3	280	309	344	460	4	-	0,3	-	-	-	-	
-		397	320	5	5	4,3	280	309	324	460	4	4	0,2	-	-	-	-	
-		455	337	6	6	4,2	286	330	341	514	5	5	0,15	-	-	-	-	
350		458	324	6	6	5	284	320	355	516	5	-	0,4	-	-	-	-	
-		463	324	6	6	1,8	286	310	323	514	5	5	0,25	-	-	-	-	
280	-	373,1	316	4	4	8	295	312	321	405	3	3	0,15	HJ 1056	3,6	16	31,5	
	-	406	321	5	5	0,4	300	316	325	440	4	4	0,21	-	-	-	-	
	360	417	340	5	5	3,8	300	333	364	480	4	-	0,15	-	-	-	-	
	-	417	340	5	5	3,8	300	333	344	480	4	4	0,15	-	-	-	-	
	-	433	333	5	5	4,5	298	328	331	482	4	4	0,3	-	-	-	-	
	-	467	362	6	6	6,6	306	347	366	554	5	5	0,25	-	-	-	-	
300	356	402	340	4	4	9,7	317	335	360	443	3	-	0,1	-	-	-	-	
	-	402	340	4	4	9,7	317	335	344	443	3	3	0,15	-	-	-	-	
	-	410	341	4	4	4,1	317	336	345	443	3	3	0,14	-	-	-	-	
	-	451	364	5	5	4,8	320	358	368	520	4	4	0,15	-	-	-	-	
	-	451	364	5	5	5,6	320	352	368	520	4	4	0,2	-	-	-	-	
	-	505	385	7,5	7,5	4	328	380	368	592	6	6	0,1	-	-	-	-	
	-	535	371	7,5	7,5	11	332	365	375	588	6	6	0,27	-	-	-	-	



6.1 Single row cylindrical roller bearings

d 320 – 400 mm

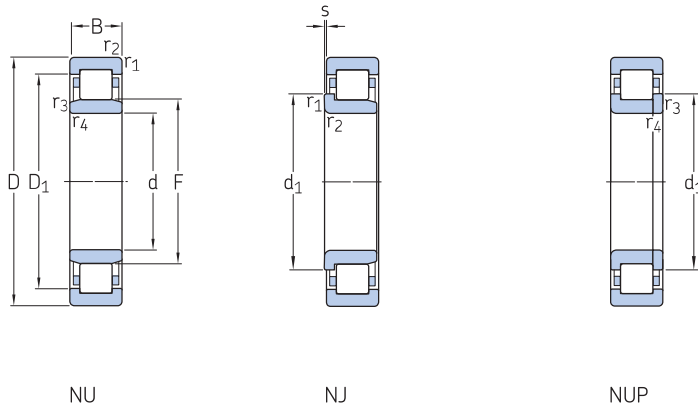

Principal dimensions			Basic load ratings		Fatigue load limit	Speed ratings		Mass	Designations Bearing with standard cage	Alternative standard cage ¹⁾
d	D	B	C	C ₀		Reference speed	Limiting speed			
mm			kN		kN	r/min		kg	–	
320	440	56	693	1 200	110	1 500	2 000	26	NU 1964 ECMA	–
	480	74	880	1 430	132	1 400	1 400	48	▶ NJ 1064 MA	–
	480	74	880	1 430	132	1 400	1 400	48,5	▶ NU 1064 MA	–
340	580	92	1 830	2 750	232	1 000	1 200	115	NU 264 ECM	–
	580	150	3 190	5 000	415	1 000	1 900	176	NU 2264 ECML	–
	670	200	4 730	7 500	600	850	1 500	370	NU 2364 ECMA	–
	460	56	682	1 200	108	1 400	1 900	27,5	NU 1968 ECMA	–
360	460	72	1 020	2 040	186	1 400	1 900	37	NJ 2968 ECMA	–
	520	133	2 200	4 150	365	1 100	1 700	109	NU 3068 MA	–
	580	190	3 470	5 850	490	950	1 600	217	NU 3168 ECMA	–
	620	165	2 640	4 500	365	1 000	1 500	226	▶ NU 2268 MA	–
	710	212	5 610	8 650	680	800	1 400	439	NU 2368 ECMA	–
	480	56	781	1 460	129	1 400	2 000	29	NU 1972 ECMP	–
380	540	82	1 100	1 830	163	1 300	1 600	67,5	▶ NU 1072 MA	–
	600	192	3 410	6 100	490	900	1 500	226	NU 3172 ECMA	–
	650	170	2 920	4 900	400	950	1 400	257	NU 2272 MA	–
	750	224	5 010	8 150	630	850	1 300	510	NU 2372 ECMA	–
	480	46	561	1 120	98	1 300	2 000	20	NU 1876 ECMP	–
	480	46	561	1 120	98	1 300	2 000	21	NJ 1876 ECMP	–
	560	82	1 140	1 930	170	1 200	1 600	70	▶ NU 1076 MA	–
	560	82	1 140	1 930	170	1 200	1 600	71	▶ NJ 1076 MA	–
	560	135	2 380	4 750	400	1 000	1 800	109	NU 3076 ECMP	–
	680	175	3 960	6 400	510	850	1 300	288	NU 2276 ECMA	–
400	500	46	572	1 180	100	1 300	1 900	21,5	NU 1880 MP	–
	500	46	572	1 180	96,5	1 300	1 900	22	NJ 1880 MP	–
	500	46	572	1 180	96,5	1 300	1 900	22,5	NUP 1880 MP	–
	540	82	1 380	2 800	245	1 200	1 600	57	NJ 2980 ECMA	–
	540	106	1 760	3 750	320	1 000	1 500	74,5	NU 3980 ECMA	–
	600	90	1 380	2 320	196	1 100	1 500	90	▶ NU 1080 MA	–
	600	90	1 380	2 320	196	1 100	1 500	93	NJ 1080 MA	–

▶ Popular item

¹⁾ When ordering bearings with an alternative standard cage the suffix of the standard cage has to be replaced by the suffix of the alternative cage. For example NU .. ECP becomes NU .. ECML (for permissible speed → [page 511](#)).

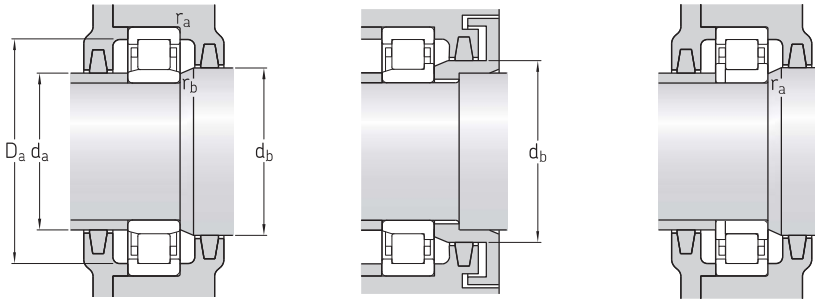

Dimensions			Abutment and fillet dimensions										Calculation factor k_r	Angle ring Designation	Mass	Dimensions	
d	d_1 ≈	D_1 ≈	F, E	$r_{1,2}$ min.	$r_{3,4}$ min.	s max.	d_a min.	d_a max.	d_b, D_a min.	D_a max.	r_a max.	r_b max.				B_1	B_2
mm			mm										-	-	kg	mm	
320	-	404	348	3	3	1,5	333	347	355	427	2,5	2,5	0,11	-	-	-	-
	376	422	360	4	4	9,7	335	355	380	465	3	-	0,1	-	-	-	-
	-	422	360	4	4	9,7	335	355	364	465	3	3	0,15	-	-	-	-
	-	494	392	5	5	4,8	338	386	394	562	4	4	0,13	-	-	-	-
	-	506	380	5	5	5	338	376	394	562	4	4	0,1	-	-	-	-
-	565	405	7,5	7,5	11	348	400	394	642	6	6	0,15	-	-	-	-	-
340	-	421	370	3	3	1,8	353	365	374	447	2,5	2,5	0,07	-	-	-	-
	377	421	367	3	3	3,8	353	363	381	447	2,5	-	0,07	-	-	-	-
	-	465	385	5	5	7	360	380	389	502	4	4	0,15	-	-	-	-
	-	507	390,5	5	5	14	360	388	403	560	4	4	0,27	-	-	-	-
	-	515	416	6	6	8	366	401	421	594	5	5	0,3	-	-	-	-
-	602	425	7,5	7,5	11	368	420	389	682	6	6	0,15	-	-	-	-	-
360	-	438	387,5	3	3	2	375	382	392	465	2,5	2,5	0,1	-	-	-	-
	-	475	405	5	5	6,5	378	400	410	522	4	4	0,15	-	-	-	-
	-	475	420	5	5	9,4	380	407	425	580	4	4	0,21	-	-	-	-
	-	542	437	6	6	16,7	386	428	442	624	5	5	0,2	-	-	-	-
	-	617	465	7,5	7,5	10	392	453	470	718	6	6	0,25	-	-	-	-
380	-	449	406	2,1	2,1	2,5	390	400	410	470	1	1	0,1	-	-	-	-
	415	449	406	2,1	2,1	1,5	392	400	421	469	2	-	0,1	-	-	-	-
	-	495	425	5	5	10,8	398	420	430	542	4	4	0,15	-	-	-	-
	443	495	425	5	5	10,8	398	420	448	542	4	-	0,1	-	-	-	-
	-	506	425	5	5	8,5	398	417	430	542	4	4	0,17	-	-	-	-
-	595	451	6	6	8,3	406	445	457	654	5	5	0,2	-	-	-	-	-
400	-	465	423	2,1	2,1	3,3	410	419	428	490	2	2	0,05	-	-	-	-
	433	465	423	2,1	2,1	3,3	410	419	436	490	2	-	0,05	-	-	-	-
	432	464	423	2,1	2,1	-	410	-	438	488	2	-	0,1	-	-	-	-
	448	495	435	4	4	0,9	415	430	454	525	3	-	0,15	-	-	-	-
	-	500	434,5	4	4	4	415	429	439	524	3	3	0,1	-	-	-	-
-	527	450	5	5	14	418	446	455	582	4	4	0,15	-	-	-	-	-
-	472	526	450	5	5	5	418	445	478	582	4	-	0,15	-	-	-	-



6.1 Single row cylindrical roller bearings

d 420 – 530 mm

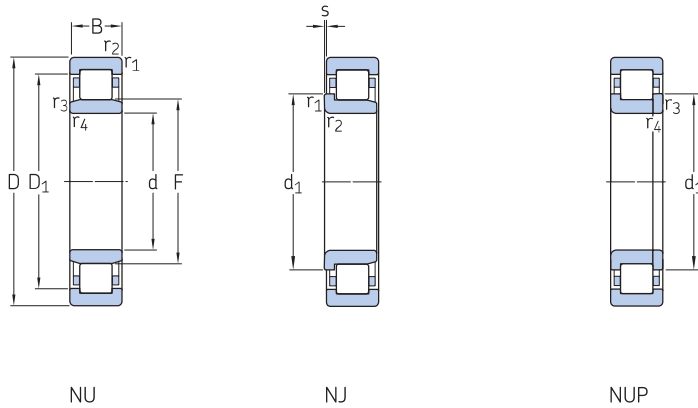

Principal dimensions			Basic load ratings		Fatigue load limit	Speed ratings		Mass	Designations Bearing with standard cage	Alternative standard cage ¹⁾
d	D	B	C	C ₀		Reference speed	Limiting speed			
mm			kN		kN	r/min		kg	–	
420	520	46	572	1 200	102	1 200	1 800	22	NU 1884 MP	–
	560	82	1 400	2 850	255	1 100	1 500	60	NU 2984 ECMA	–
	560	106	1 680	3 650	310	950	1 500	79,5	NUP 3984 ECMA	–
	620	90	1 420	2 450	200	1 100	1 400	94	NU 1084 MA	–
	700	224	4 950	9 000	695	750	1 300	365	NU 3184 ECMA	–
440	600	74	1 060	2 000	170	1 100	1 400	53	NU 1988 MA	–
	600	95	1 870	3 900	340	1 100	1 600	81	▶ NU 2988 ECML	–
	600	95	1 870	3 900	340	1 100	1 600	83	NJ 2988 ECML	–
	650	122	2 550	4 900	390	8 500	1 300	145	NU 2088 ECMA	–
	720	226	5 120	10 000	765	700	1 200	388	NU 3188 ECMA/HB1	–
460	580	72	1 080	2 400	193	1 100	1 400	48	NJ 2892 ECMA	–
	620	95	1 720	3 600	310	1 000	1 300	89	NJ 2992 ECMA	–
	620	118	2 050	4 550	375	850	1 300	112	NUP 3992 ECMA	–
	680	100	1 650	2 850	224	950	1 200	115	NU 1092 MA	–
	760	240	5 280	9 650	735	670	1 100	450	NU 3192 ECMA/HB1	–
	830	165	4 180	6 800	510	750	1 100	415	NU 1292 MA	–
	830	212	5 120	8 650	655	700	1 100	527	▶ NU 2292 MA	–
480	650	78	1 170	2 240	183	950	1 300	76	NU 1996 MA	–
	700	100	1 680	3 000	232	900	1 200	130	NU 1096 MA	–
	700	128	2 860	5 600	430	750	1 200	179	NU 2096 ECMA	–
	790	248	5 940	10 800	800	630	1 100	507	NU 3196 ECMA/HB1	–
500	670	100	2 050	4 250	355	900	1 200	107	NU 29/500 ECMA	–
	720	100	1 720	3 100	236	900	1 100	135	▶ NU 10/500 MA	–
	720	128	2 920	5 850	440	750	1 100	180	NU 20/500 ECMA	–
	720	167	3 800	7 350	560	750	1 100	233	NU 30/500 ECMA	–
	830	264	6 440	12 000	880	600	1 000	595	NU 31/500 ECMA/HB1	–
	920	185	5 280	8 500	620	670	950	575	NU 12/500 MA	–
530	710	106	2 380	5 000	390	850	1 100	130	NUP 29/530 ECMA	–
	780	112	2 290	4 050	305	800	1 000	190	NU 10/530 MA	–
	780	145	3 740	7 350	550	670	1 000	253	NU 20/530 ECMA	–
	870	272	7 480	14 600	1 040	560	950	660	NU 31/530 ECMA/HB1	–

▶ Popular item

¹⁾ When ordering bearings with an alternative standard cage the suffix of the standard cage has to be replaced by the suffix of the alternative cage. For example NU .. ECP becomes NU .. ECML (for permissible speed → [page 511](#)).

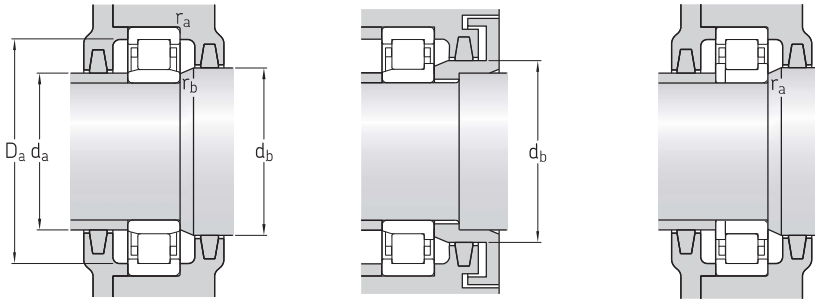

Dimensions				Abutment and fillet dimensions									Calculation factor k_r	Angle ring Designation	Mass	Dimensions	
d	d_1 ≈	D_1 ≈	F, E	$r_{1,2}$ min.	$r_{3,4}$ min.	s max.	d_a min.	d_a max.	d_b, D_a min.	D_a max.	r_a max.	r_b max.				B_1	B_2
mm				mm									-	-	kg	mm	
420	-	488	447	2,1	2,1	3,3	431	442	452	508	2	2	0,1	-	-	-	-
	-	512	449	4	4	2,4	435	444	463	545	3	3	0,07	-	-	-	-
	468	518	455	4	4	-	436	-	472	544	3	-	0,15	-	-	-	-
-	547	470	5	5	14	438	466	475	602	4	4	0,15	-	-	-	-	-
	613	485	6	6	14,2	446	478	490	694	5	5	0,21	-	-	-	-	-
440	-	544	482	4	4	5,5	455	477	487	585	3	3	0,07	-	-	-	-
	-	552	481,5	4	4	2,4	455	476	487	584	3	3	0,07	-	-	-	-
	496	551	481,5	4	4	1,5	455	475	502	585	3	-	0,15	-	-	-	-
-	577	487	6	6	11,9	463	483	492	627	5	5	0,14	-	-	-	-	-
	637	509	6	6	12,5	466	500	514	694	5	5	0,21	-	-	-	-	-
460	499	543	489	3	3	1,1	473	485	505	567	2,5	-	0,07	-	-	-	-
	508	566	495	4	4	4	475	490	515	605	3	-	0,07	-	-	-	-
	515	571	501	4	4	-	476	-	520	604	3	-	0,15	-	-	-	-
-	600	516	6	6	15,9	483	511	521	657	5	5	0,15	-	-	-	-	-
	662	529,3	7,5	7,5	13	492	519	534	728	6	6	0,27	-	-	-	-	-
	715	554	7,5	7,5	6,4	492	542	559	798	6	6	0,13	-	-	-	-	-
-	706	554	7,5	7,5	16,5	492	542	559	798	6	6	0,2	-	-	-	-	-
480	-	592	525	5	5	6,5	498	517	530	632	4	4	0,07	-	-	-	-
	-	620	536	6	6	15,9	503	531	541	677	5	5	0,15	-	-	-	-
	-	629	533	6	6	12,7	503	529	538	677	5	5	0,14	-	-	-	-
-	699	547	7,5	7,5	16	512	536	552	758	6	6	0,21	-	-	-	-	-
500	-	619	539,5	5	5	3	518	534	549	652	4	4	0,1	-	-	-	-
	-	640	556	6	6	11,2	523	550	561	697	5	5	0,15	-	-	-	-
	-	649	553	6	6	12,7	523	549	558	697	5	5	0,14	-	-	-	-
-	650	540,8	6	6	8,6	523	532	546	697	5	5	0,21	-	-	-	-	-
	728	576	7,5	7,5	14,5	532	564	581	798	6	6	0,21	-	-	-	-	-
	780	603,1	7,5	7,5	13,9	532	593	610	888	6	6	0,17	-	-	-	-	-
530	590	656	573	5	5	-	548	-	595	692	4	-	0,15	-	-	-	-
	-	692	593	6	6	10,4	553	585	598	757	5	5	0,15	-	-	-	-
	-	704	591	6	6	6,8	553	587	596	757	5	5	0,2	-	-	-	-
-	764	612	7,5	7,5	3	562	605	617	838	6	6	0,21	-	-	-	-	-



6.1 Single row cylindrical roller bearings

d 560 – 1 000 mm

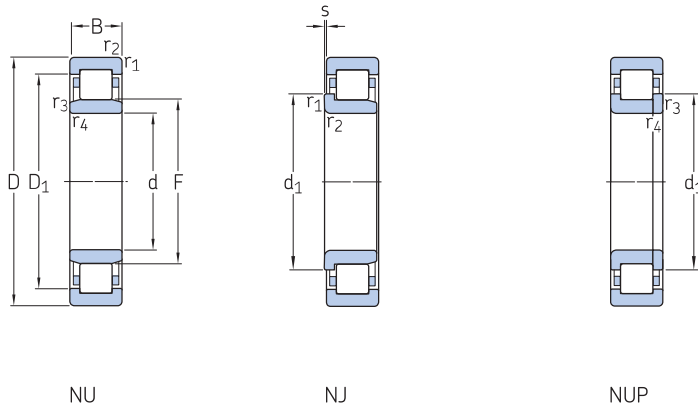

Principal dimensions			Basic load ratings		Fatigue load limit	Speed ratings		Mass	Designations Bearing with standard cage	Alternative standard cage ¹⁾
d	D	B	C	C ₀		Reference speed	Limiting speed			
mm			kN		kN	r/min		kg	–	
560	750	112	2 460	5 700	450	800	1 000	145	NU 29/560 ECMA	–
	820	115	2 330	4 250	310	750	1 000	210	NU 10/560 MA	–
	820	150	3 800	7 650	560	630	1 000	290	NU 20/560 ECMA	–
1 030	1 030	206	7 210	11 200	780	560	800	805	NU 12/560 MA	–
	1 030	272	9 900	16 600	1 160	530	800	1 090	NU 22/560 ECMA	–
600	730	60	897	2 080	108	800	1 000	54	NU 18/600 ECMA/HB1	–
	870	118	2 750	5 100	365	700	900	240	NU 10/600 MA	–
	870	155	4 180	8 000	570	600	900	325	NU 20/600 ECMA	–
630	780	69	1 100	2 500	183	750	950	75	NJ 18/630 ECMA/HB1	–
	850	100	2 240	4 400	315	700	900	168	NU 19/630 ECMA/HB1	–
	850	128	3 300	7 200	510	700	900	224	NU 29/630 ECMA/HB1	–
850	850	128	3 300	7 200	510	700	900	230	NJ 29/630 ECMA/HB1	–
	920	170	4 730	9 500	670	560	850	400	NU 20/630 ECMA	–
710	870	95	1 940	5 000	375	630	850	130	NJ 28/710 ECMA	–
	950	140	3 740	8 300	570	600	800	297	NU 29/710 ECMA	–
	1 030	140	4 680	8 500	570	560	750	415	NU 10/710 ECMA	–
1 030	1 030	185	5 940	12 000	815	480	700	540	NU 20/710 ECMA/HB1	–
	1 090	150	4 730	8 800	585	430	670	487	NU 10/750 ECMA/HB1	–
1 090	1 090	195	7 040	14 600	980	430	670	635	NU 20/750 ECMA	–
	980	82	1 720	4 150	190	530	700	137	NU 18/800 ECMA	–
1 150	1 150	200	7 040	14 600	950	400	630	715	NU 20/800 ECMA	–
	850	106	2 120	6 000	240	500	670	193	NU 28/850 MA	–
1 220	1 220	212	8 420	18 600	1 200	360	560	880	NU 20/850 ECMA	–
	900	85	1 980	4 900	240	450	600	169	NU 18/900 ECMA	–
1 180	1 180	165	5 280	12 500	800	430	560	514	NU 29/900 ECMA/HB1	–
	1 000	100	2 640	6 550	400	400	530	265	NU 18/1000 MA/HB1	–
1 220	1 220	100	2 640	6 550	400	400	530	269	NUP 18/1000 MA/HB1	–

¹⁾ When ordering bearings with an alternative standard cage the suffix of the standard cage has to be replaced by the suffix of the alternative cage. For example NU .. ECP becomes NU .. ECML (for permissible speed → [page 511](#)).

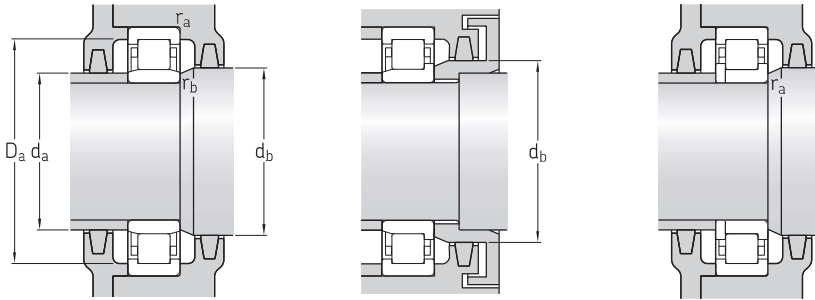

Dimensions				Abutment and fillet dimensions										Calculation factor k_r	Angle ring Designation	Mass	Dimensions	
d	d_1	D_1	F, E	$r_{1,2}$	$r_{3,4}$	s	d_a	d_a	d_b, D_a	D_a	r_a	r_b	B_1				B_2	
mm	mm	mm	mm	min.	min.	max.	min.	max.	min.	max.	max.	max.	mm	mm				
560	-	693	608	5	5	4,5	578	600	613	732	4	4	0,07	-	-	-	-	
	-	726	625	6	6	12,3	583	617	630	797	5	5	0,15	-	-	-	-	
	-	741	626	6	6	6,7	583	616	631	797	5	5	0,14	-	-	-	-	
-	892	668	668	9,5	9,5	10,3	600	657	674	990	8	8	0,13	-	-	-	-	
	900	664	664	9,5	9,5	3	594	658	674	990	8	8	0,1	-	-	-	-	
600	-	681	632	3	3	0,7	613	625	637	717	2,5	2,5	0,05	-	-	-	-	
	-	779	667	6	6	14	623	658	672	847	5	5	0,15	-	-	-	-	
	-	793	661	6	6	6,1	623	652	667	847	5	5	0,14	-	-	-	-	
630	682	724	667	4	4	1,5	645	662	685	765	3	-	0,1	-	-	-	-	
	-	785	683	6	6	4,5	653	678	688	827	5	5	0,07	-	-	-	-	
	-	782	683	6	6	7,1	653	678	688	827	5	5	0,07	-	-	-	-	
-	703	782	683	6	6	7,1	653	678	709	827	5	-	0,07	-	-	-	-	
	832	699	699	7,5	7,5	8,7	658	690	705	892	6	6	0,14	-	-	-	-	
710	766	817	751	4	4	1,5	728	745	771	853	3	-	0,15	-	-	-	-	
	-	875	766	6	6	8,7	734	760	772	648	5	5	0,1	-	-	-	-	
	-	939	778	7,5	7,5	17	738	769	783	1002	6	6	0,15	-	-	-	-	
-	939	787	787	7,5	7,5	10	738	780	793	1002	6	6	0,14	-	-	-	-	
	750	993	830	7,5	7,5	12,8	778	823	838	1062	6	6	0,15	-	-	-	-	
-	993	832	832	7,5	7,5	12,8	778	823	838	1062	6	6	0,14	-	-	-	-	
	800	920	846	5	5	1	818	840	861	962	4	4	0,15	-	-	-	-	
1051		882	882	7,5	7,5	2	828	868	888	1122	6	6	0,14	-	-	-	-	
850	961	902	5	5	7	868	891	908	1012	4	4	0,07	-	-	-	-		
	1110	942	942	7,5	7,5	2	878	936	956	1190	6	6	0,17	-	-	-	-	
900	1026	948	5	5	4,7	918	942	956	1072	4	4	0,05	-	-	-	-		
	1096	969	969	6	6	5,9	923	958	975	1157	5	5	0,07	-	-	-	-	
1 000	1143	1053	6	6	12,1	1023	1040	1060	1197	5	5	0,05	-	-	-	-		
	1072	1146	1053	6	6	-	1025	-	1080	1196	5	-	0,2	-	-	-	-	



6.2 High-capacity cylindrical roller bearings

d 100 – 170 mm

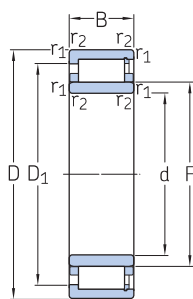

NUH..ECMH

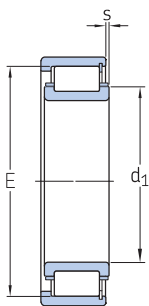

NCF..ECJB

Principal dimensions			Basic load ratings		Fatigue load limit	Speed ratings		Mass	Designation
d	D	B	dynamic C	static C ₀		Reference speed	Limiting speed		
mm			kN		kN	r/min		kg	–
100	180	46	400	475	57	4 000	4 500	5,1	NUH 2220 ECMH
	215	73	710	800	91,5	3 200	3 800	13	NUH 2320 ECMH
110	200	53	465	550	64	3 600	4 000	7,3	NUH 2222 ECMH
	240	80	830	965	110	3 000	3 400	18	NUH 2322 ECMH
120	215	58	550	670	76,5	3 400	3 600	9	NUH 2224 ECMH
	260	86	965	1 120	125	2 800	3 200	22,5	NUH 2324 ECMH
130	230	64	630	780	88	3 200	3 400	11	NUH 2226 ECMH
	280	93	1 120	1 340	146	2 400	3 000	28	NUH 2326 ECMH
	280	93	1 120	1 340	146	2 400	3 400	29	NCF 2326 ECJB
140	250	68	680	880	96,5	2 800	3 200	14,5	NUH 2228 ECMH
	250	68	680	880	96,5	2 800	3 600	14,5	NCF 2228 ECJB
	300	102	1 250	1 530	163	2 400	2 800	35	NUH 2328 ECMH
	300	102	1 250	1 530	163	2 400	3 200	35,5	NCF 2328 ECJB
150	270	73	780	1 040	112	2 600	2 800	18	NUH 2230 ECMH
	270	73	780	1 040	112	2 600	3 400	18	NCF 2230 ECJB
	320	108	1 430	1 760	183	2 200	2 600	42	NUH 2330 ECMH
	320	108	1 430	1 760	183	2 200	3 000	43,5	NCF 2330 ECJB
160	290	80	980	1 270	134	2 400	2 600	23	NUH 2232 ECMH
	290	80	980	1 270	134	2 400	3 000	23,5	NCF 2232 ECJB
	340	114	1 400	2 000	196	1 800	2 400	50,5	NUH 2332 ECMH
	340	114	1 400	2 000	196	1 800	2 800	50,5	NCF 2332 ECJB
	340	114	1 600	2 000	196	2 000	2 800	50,5	NCF 2332 ECJB/PEX
	340	114	1 600	2 000	196	2 000	2 400	50,5	NUH 2332 ECMH/PEX
170	310	86	1 600	1 530	156	2 200	2 400	28,5	NUH 2234 ECMH
	310	86	1 160	1 530	156	2 200	2 800	28	NCF 2234 ECJB
	360	120	1 540	2 200	216	1 700	2 200	59,5	NUH 2334 ECMH
	360	120	1 540	2 200	216	1 700	2 600	58,5	NCF 2334 ECJB
	360	120	1 760	2 200	216	1 900	2 600	58,5	NCF 2334 ECJB/PEX
	360	120	1 760	2 200	216	1 900	2 200	59,5	NUH 2334 ECMH/PEX

6.2



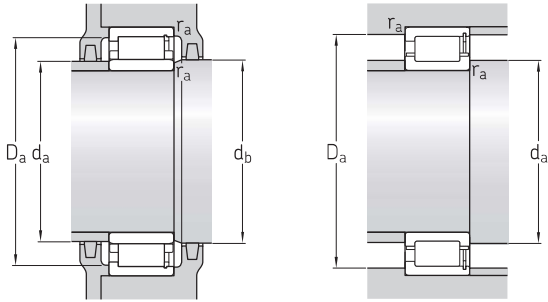

Dimensions			Abutment and fillet dimensions							Calculation factor		
d	d ₁ ≈	D ₁ ≈	F, E	r _{1,2} min.	s max.	d _a min.	d _a max.	d _b min.	D _a min.	D _a max.	r _a max.	k _r
mm						mm						-
100	-	156	119	2,1	1	113	116	122	159	167	2	0,16
	-	182	127,5	3	2,2	114	124	131	186	199	2,5	0,2
110	-	173	132,5	2,1	2,2	122	129	135	177	187	2	0,16
	-	200	143	3	2,3	124	139	146	206	225	2,5	0,2
120	-	187	143,5	2,1	2,2	132	140	146	191	201	2	0,16
	-	218	154	3	2,4	134	150	157	224	244	2,5	0,2
130	-	201	153,5	3	2,6	144	150	157	205	215	2,5	0,16
	-	235	167	4	3,1	147	163	170	241	261	3	0,2
	181	235	247	4	8,7	147	174	-	241	261	3	0,2
140	-	216	169	3	3,2	154	165	172	220	235	2,5	0,16
	179	216	225	3	4,4	154	174	-	220	235	2,5	0,16
	-	251	180	4	3,9	157	175	183	257	282	3	0,2
	195	251	264	4	9,7	157	188	-	257	282	3	0,2
150	-	233	182	3	3,3	164	178	186	237	254	2,5	0,16
	193	233	242	3	4,9	164	188	-	237	254	2,5	0,16
	-	285	193	4	4,1	167	188	196	284	302	3	0,2
	209	269	283	4	10,5	167	201	-	276	302	3	0,2
160	-	250	193	3	3	174	189	196	256	274	2,5	0,16
	205	250	261	3	4,5	174	199	-	256	274	2,5	0,16
	-	285	204	4	2,5	177	199	207	292	321	3	0,2
	221	281	300	4	11	177	213	-	290	321	3	0,2
	221	281	300	4	11	177	213	-	290	321	3	0,2
170	-	285	204	4	2,5	177	199	207	292	321	3	0,2
	-	269	205	4	2,4	187	201	208	275	292	3	0,16
	219	270	281	4	4,2	187	212	-	275	292	3	0,16
	-	301	216	4	3,8	186	211	219	308	341	3	0,2
	234	301	316	4	10	186	225	-	308	341	3	0,2
	234	301	316	4	10	186	225	-	308	341	3	0,2
-	301	216	4	3,8	186	211	219	308	341	3	0,2	



6.2 High-capacity cylindrical roller bearings

d 180 – 240 mm

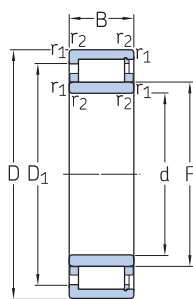

NUH..ECMH

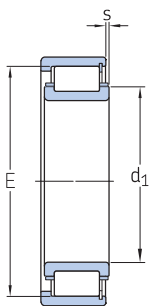

NCF..ECJB

Principal dimensions			Basic load ratings		Fatigue load limit	Speed ratings		Mass	Designation
d	D	B	dynamic C	static C ₀		Reference speed	Limiting speed		
mm			kN		kN	r/min		kg	–
180	320	86	1 200	1 600	166	2 200	2 400	29,5	NUH 2236 ECMH
	320	86	1 200	1 600	166	2 200	2 800	30	NCF 2236 ECJB
	380	126	1 720	2 400	232	1 600	2 200	68	NUH 2336 ECMH
	380	126	1 720	2 400	232	1 600	2 400	67,5	NCF 2336 ECJB
	380	126	1 960	2 400	232	1 800	2 400	67,5	NCF 2336 ECJB/PEX
	380	126	1 960	2 400	232	1 800	2 200	68	NUH 2336 ECMH/PEX
190	340	92	1 320	1 760	180	2 000	2 200	36	NUH 2238 ECMH
	340	92	1 320	1 760	180	2 000	2 600	36,5	NCF 2238 ECJB
	400	132	1 940	2 750	255	1 500	2 000	78,5	NUH 2338 ECMH
	400	132	1 940	2 750	255	1 500	2 200	78	NCF 2338 ECJB
	400	132	2 240	2 750	255	1 700	2 200	78	NCF 2338 ECJB/PEX
	400	132	2 240	2 750	255	1 700	2 000	78,5	NUH 2338 ECMH/PEX
200	360	98	1 460	2 000	200	1 900	2 200	43,5	NUH 2240 ECMH
	360	98	1 460	2 000	200	1 900	2 400	43	NCF 2240 ECJB
	420	138	2 200	3 200	300	1 400	1 900	92,5	NUH 2340 ECMH
	420	138	2 200	3 200	300	1 400	2 200	91,5	NCF 2340 ECJB
	420	138	2 550	3 200	300	1 600	2 200	91,5	NCF 2340 ECJB/PEX
	420	138	2 550	3 200	300	1 600	1 900	92,5	NUH 2340 ECMH/PEX
220	400	108	1 760	2 600	240	1 600	1 900	59	NUH 2244 ECMH
	400	108	1 760	2 600	240	1 600	2 200	58,5	NCF 2244 ECJB
	400	108	2 000	2 600	240	1 700	1 900	59	NUH 2244 ECMH/PEX
	400	108	2 000	2 600	240	1 700	2 200	58,5	NCF 2244 ECJB/PEX
	460	145	2 510	3 650	335	1 300	1 700	116	NUH 2344 ECMH
	460	145	2 510	3 650	335	1 300	2 000	116	NCF 2344 ECJB
240	460	145	2 900	3 650	335	1 400	1 700	116	NUH 2344 ECMH/PEX
	440	120	1 980	3 050	275	1 400	1 700	80	NUH 2248 ECMH
	440	120	2 279	3 050	275	1 600	1 700	80	NUH 2248 ECMH/PEX
	500	155	2 750	4 000	345	1 200	1 500	143	NUH 2348 ECMH
	500	155	3 150	4 000	345	1 300	1 500	143	NUH 2348 ECMH/PEX

6.2



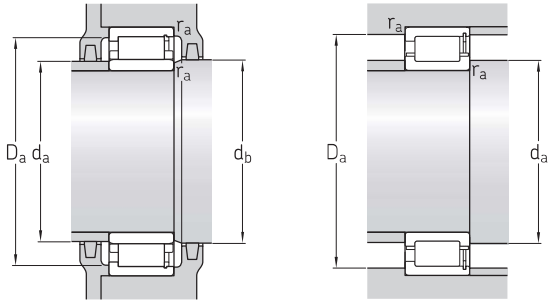

Dimensions						Abutment and fillet dimensions						Calculation factor
d	d ₁ ≈	D ₁ ≈	F, E	r _{1,2} min.	s max.	d _a min.	d _a max.	d _b min.	D _a min.	D _a max.	r _a max.	k _r
mm						mm						–
180	–	279	215	4	2,4	197	211	218	285	302	3	0,16
	229	279	291	4	4,2	197	222	–	285	302	3	0,16
	–	322	227	4	3,7	196	222	230	330	361	3	0,2
	247	320	339	4	10,5	196	237	–	329	361	3	0,2
	247	320	339	4	10,5	196	237	–	329	361	3	0,2
–	322	227	4	3,7	196	222	230	311	361	3	0,2	
190	–	296	228	4	3,1	207	224	231	302	321	3	0,16
	242	293	308	4	5	207	235	–	300	321	3	0,16
	–	342	240	5	4,1	209	234	244	351	380	4	0,2
	262	342	360	5	9,5	209	251	–	351	380	4	0,2
	262	342	360	5	9,5	209	251	–	351	380	4	0,2
–	342	240	5	4,1	209	234	244	351	380	4	0,2	
200	–	312	241	4	3,4	217	236	245	318	341	3	0,16
	256	312	325	4	5,1	217	249	–	318	341	3	0,16
	–	358	253	5	4,3	220	247	257	367	399	4	0,2
	275	356	377	5	9,4	220	264	–	367	399	4	0,2
	275	356	377	5	9,4	220	264	–	367	399	4	0,2
–	358	253	5	4,3	220	247	257	367	399	4	0,2	
220	–	350	259	4	2,5	237	254	263	359	383	3	0,16
	279	349	367	4	7,9	237	269	–	358	383	3	0,16
	–	350	259	4	2,5	237	254	263	359	383	3	0,16
	279	349	367	4	7,9	237	269	–	358	383	3	0,16
	–	392	277	5	3	240	270	281	334	439	4	0,2
–	392	277	5	10,4	240	290	–	386	440	4	0,2	
–	392	277	5	3	240	270	281	334	439	4	0,2	
240	–	312	287	4	3,5	258	294	299	299	422	3	0,16
	–	312	287	4	3,5	258	294	299	299	422	3	0,16
	–	426	299	5	3,1	260	298	303	362	479	4	0,2
	–	426	299	5	3,1	260	298	303	362	479	4	0,2



6.3 Single row full complement cylindrical roller bearings

d 20 – 85 mm

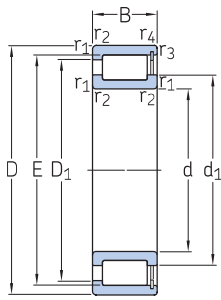

NCF

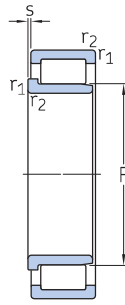

NJG

Principal dimensions			Basic load ratings		Fatigue load limit	Speed ratings		Mass	Designation
d	D	B	dynamic C	static C ₀		Reference speed	Limiting speed		
mm			kN	kN	kN	r/min	kg	–	
20	42	16	28,1	28,5	3,1	8 500	10 000	0,11	▶ NCF 3004 CV
25	47	16	31,9	35,5	3,8	7 000	9 000	0,12	NCF 3005 CV
	62	24	68,2	68	8,5	4 500	5 600	0,38	NJG 2305 VH
30	55	19	39,6	44	5,3	13 000	15 000	0,2	▶ NCF 3006 CV
	72	27	84,2	86,5	11	4 000	4 800	0,56	NJG 2306 VH
35	62	20	48,4	56	6,55	5 300	6 700	0,26	NCF 3007 CV
	80	31	108	114	14,3	3 400	4 300	0,75	NJG 2307 VH
40	68	21	57,2	69,5	8,15	4 800	6 000	0,31	▶ NCF 3008 CV
	90	33	145	156	20	3 000	3 600	1	▶ NJG 2308 VH
45	75	23	60,5	78	9,15	4 300	5 300	0,4	NCF 3009 CV
	100	25	110	112	14	7 500	9 000	0,94	NJG 309 VH
	100	36	172	196	25,5	2 800	3 400	1,4	NJG 2309 VH
50	80	23	76,5	98	11,8	4 000	5 000	0,43	▶ NCF 3010 CV
	55	90	26	105	140	17,3	3 400	4 300	0,64
120		43	233	260	33,5	2 200	2 800	2,3	NJG 2311 VH
60	85	16	55	80	9,15	3 600	4 500	0,27	NCF 2912 CV
	95	26	106	146	18,3	3 400	4 000	0,69	NCF 3012 CV
65	90	16	58,3	88	10,2	3 200	4 000	0,31	NCF 2913 CV
	100	26	112	163	20	3 000	3 800	0,73	NCF 3013 CV
	140	48	303	360	46,5	1 900	2 400	3,55	NJG 2313 VH
70	100	19	76,5	116	13,7	3 000	3 800	0,49	▶ NCF 2914 CV
	110	30	128	173	22,4	6 000	7 000	1	NCF 3014 CV
	150	51	336	400	50	1 800	2 200	4,4	NJG 2314 VH
75	105	19	79,2	125	14,6	2 800	3 600	0,52	NCF 2915 CV
	115	30	134	190	24,5	2 600	3 200	1,05	NCF 3015 CV
	160	55	396	480	60	1 600	2 000	5,35	NJG 2315 VH
80	110	19	80,9	132	15,6	2 600	3 400	0,55	▶ NCF 2916 CV
	125	34	165	228	29	2 400	3 000	1,45	NCF 3016 CV
	170	58	457	570	71	1 500	1 900	6,4	NJG 2316 VH
85	120	22	102	166	20,4	6 300	6 300	0,81	NCF 2917 CV
	130	34	172	236	30	2 400	3 000	1,5	NCF 3017 CV
	180	60	484	620	76,5	1 400	1 800	7,4	NJG 2317 VH



▶ Popular item

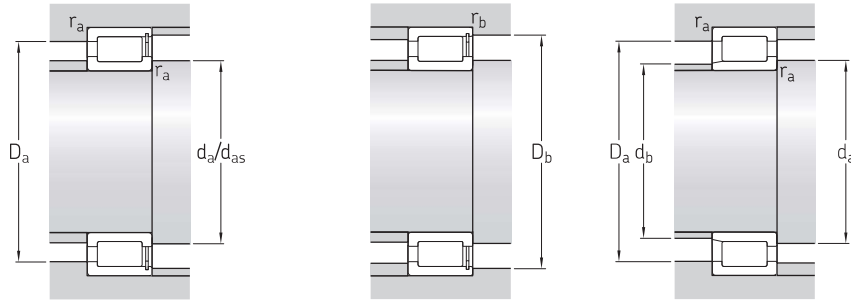

Dimensions							Abutment and fillet dimensions							Calculation factor
d	d ₁ ≈	D ₁ ≈	E, F	r _{1,2} min.	r _{3,4} min.	s max.	d _a min.	d _{as} ¹⁾	d _b max.	D _a max.	D _b max.	r _a max.	r _b max.	k _r
mm							mm							-
20	29	33	36,81	0,6	0,3 ²⁾	1,5	24	26,9	-	38	39	0,6	0,3	0,3
	36,1	48,2	31,74	1,1	-	1,7	29	32,3	-	43	44	0,6	0,3	0,3
25	34	39	42,51	0,6	0,3	1,5	29	32,3	-	43	44	0,6	0,3	0,3
	36,1	48,2	31,74	1,1	-	1,7	31	33,9	30	55	-	1	-	0,35
30	40	45	49,6	1	0,3 ²⁾	2	35	37,8	-	50	52	1	0,3	0,3
	43,2	56,4	38,36	1,1	-	1,8	37	40,8	36,5	64	-	1	-	0,35
35	45	51	55,52	1	0,3	2	40	42,8	-	57	58	1	0,3	0,3
	50,4	65,8	44,75	1,5	-	2	43	47,6	42	71	-	1,5	-	0,35
40	50	58	61,74	1	0,3 ²⁾	2	45	47,9	-	63	65	1	0,3	0,3
	57,6	75,2	51,15	1,5	-	2,4	49	54,4	49	81	-	1,5	-	0,35
45	55	62	66,85	1	0,3	2	50	53	-	70	71	1	0,3	0,3
	62,5	80,1	56,14	1,5	-	1,7	54	59,3	54	91	-	1,5	-	0,35
	62,5	80,1	56,14	1,5	-	2,4	54	59,3	54	91	-	1,5	-	0,35
50	59	68	72,33	1	0,3 ²⁾	2	54	56,7	-	75	76	1	0,3	0,3
	75,5	98,6	67,14	2	-	2,6	65	71,3	64	109	-	2	-	0,35
55	68	79	83,54	1,1	0,6 ²⁾	2	62	65,8	-	84	86	1	0,6	0,3
	75,5	98,6	67,14	2	-	2,6	65	71,3	64	109	-	2	-	0,35
60	69	74,5	78,65	1	0,6	1	64	66,8	-	80	80	1	0,5	0,2
	71	82	86,74	1,1	0,6	2	66	68,9	-	89	91	1	0,5	0,3
65	75,5	81	85,24	1	0,6	1	70	73,4	-	85	86	1	0,5	0,2
	78	88	93,09	1,1	0,6	2	71	75,6	-	94	95	1	0,5	0,3
	89,9	116	80,7	2,1	-	3	77	85,3	78	128	-	2	-	0,35
70	80,5	88,5	92,5	1	0,6 ²⁾	1	75	78,5	-	95	96	1	0,5	0,2
	81	95	100,28	1,1	0,6 ²⁾	3	75	78,6	-	104	105	1	0,5	0,3
	93,8	121	84,2	2,1	-	3	81	89	81	138	-	2	-	0,35
75	86	93	97,5	1	0,6	1	80	83,8	-	100	101	1	0,5	0,2
	89	103	107,9	1,1	0,6	3	81	86,5	-	109	110	1	0,5	0,3
	101	131	91,2	2,1	-	3	87	96,1	88	147	-	2	-	0,35
80	90,5	99	102,7	1	0,6 ²⁾	1	85	88,6	-	105	106	1	0,5	0,2
	95	111	116,99	1,1	0,6	4	86	92	-	119	120	1	0,5	0,3
	109	141	98,3	2,1	-	4	92	104	95	157	-	2	-	0,35
85	96	105	109,5	1,1	1	1	90	93,8	-	114	114	1	1	0,2
	99	116	121,44	1,1	0,6	4	91	96,2	-	123	125	1	0,5	0,3
	118	149	107	3	-	4	100	113	104	165	-	2,5	-	0,35

¹⁾ Recommended shaft abutment diameter for axially loaded bearings → Flange support, page 512

²⁾ Parameter r_{3,4} has either the value specified here or the same value as r_{1,2}.

6.3 Single row full complement cylindrical roller bearings

d 90 – 180 mm

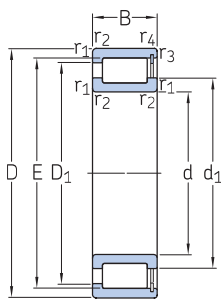

NCF

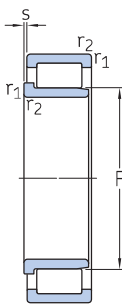

NJG

Principal dimensions			Basic load ratings		Fatigue load limit	Speed ratings		Mass	Designation
d	D	B	dynamic	static		Reference speed	Limiting speed		
			C	C ₀	P _u	r/min		kg	–
mm			kN		kN				
90	125	22	105	176	20,8	2 400	3 000	0,84	NCF 2918 CV
	140	37	198	280	35,5	2 200	2 800	1,95	NCF 3018 CV
	190	64	550	680	83	1 400	1 700	8,75	NJG 2318 VH
100	140	24	128	200	24,5	2 000	2 600	1,1	▶ NCF 2920 CV
	150	37	209	310	37,5	2 000	2 600	2,15	NCF 3020 CV
	215	73	704	900	106	1 200	1 500	13	NJG 2320 VH
110	150	24	134	220	26	1 900	2 400	1,2	▶ NCF 2922 CV
	170	45	275	400	48	3 800	4 500	3,5	NCF 3022 CV
	240	80	858	1 060	122	1 100	1 300	17,5	NJG 2322 VH
120	165	27	172	290	34,5	4 300	4 300	1,75	▶ NCF 2924 CV
	180	46	292	440	52	1 700	2 000	3,8	NCF 3024 CV
	215	58	512	735	85	1 400	1 700	9,05	NCF 2224 V
	260	86	952	1 250	140	1 000	1 200	22,5	NJG 2324 VH
130	180	30	205	360	40,5	1 600	2 000	2,35	▶ NCF 2926 CV
	200	52	413	620	72	1 500	1 900	5,8	NCF 3026 CV
	280	93	1 080	1 430	156	950	1 200	28	NJG 2326 VH
140	190	30	220	390	43	1 500	1 900	2,4	▶ NCF 2928 CV
	210	53	440	680	78	1 400	1 800	6,1	NCF 3028 CV
	250	68	693	1 020	114	1 200	1 500	14,5	NCF 2228 V
	300	102	1 230	1 660	180	850	1 100	35,5	NJG 2328 VH
150	210	36	292	490	55	1 400	1 700	3,75	▶ NCF 2930 CV
	225	56	457	710	80	1 300	1 700	7,5	NCF 3030 CV
	270	73	781	1 220	132	950	1 200	18,5	NCF 2230 V
	320	108	1 450	1 930	196	800	1 000	42,5	NJG 2330 VH
160	220	36	303	530	58,5	1 300	1 600	4	▶ NCF 2932 CV
	240	60	512	800	90	1 200	1 500	9,1	NCF 3032 CV
	290	80	990	1 500	160	950	1 200	23	NCF 2232 V
170	230	36	314	560	60	1 200	1 500	4,3	▶ NCF 2934 CV
	260	67	671	1 060	118	1 100	1 400	12,5	NCF 3034 CV
	310	86	1 100	1 700	176	900	1 100	28,5	NCF 2234 V
	360	120	1 760	2 450	236	700	900	59,5	NJG 2334 VH
180	250	42	391	695	75	1 100	1 400	6,2	▶ NCF 2936 CV
	280	74	781	1 250	134	1 100	1 300	16,5	NCF 3036 CV
	380	126	1 870	2 650	255	670	800	69,5	NJG 2336 VH

▶ Popular item



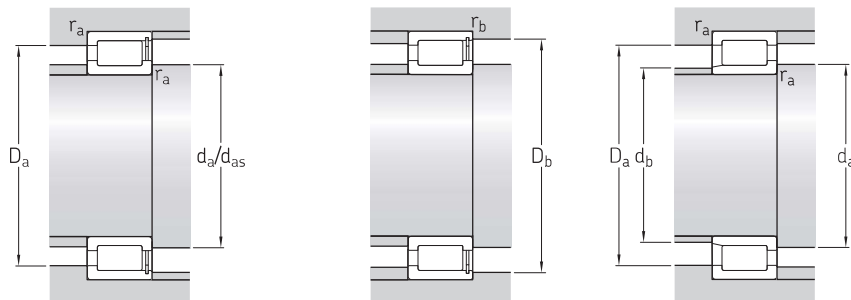

Dimensions							Abutment and fillet dimensions							Calculation factor
d	d ₁ ≈	D ₁ ≈	E, F	r _{1,2} min.	r _{3,4} min.	s max.	d _a min.	d _{as} ¹⁾	d _b max.	D _a max.	D _b max.	r _a max.	r _b max.	k _r
mm							mm							–
90	102	111	115,6	1,1	1	1	96	99,8	–	119	119	1	1	0,2
	106	124	130,11	1,5	1	4	97	103	–	133	133	1,5	1	0,3
	117	152	108,8	3	–	4	102	111	102	176	–	2,5	–	0,35
100	114	126	130,6	1,1	1	1,3	106	111	–	134	134	1	1	0,2
	115	134	139,65	1,5	1	4	107	112	–	142	143	1,5	1	0,3
	133	173	122,8	3	–	4	114	128	119	201	–	2,5	–	0,35
110	124	136	141,1	1,1	1	1,3	116	122	–	144	144	1	1	0,2
	127	149	156,13	2	1	5,5	119	124	–	160	163	2	1	0,3
	151	198	134,3	3	–	5	124	143	130	225	–	2,5	–	0,35
120	136	149	154,3	1,1	1	1,3	126	133	–	159	159	1	1	0,2
	139	160	167,58	2	1	5,5	129	135	–	170	174	2	1	0,3
	150	184	192,32	2,1	2,1	4	131	145	–	204	204	2	2	0,3
	164	213	147,39	3	–	5	134	156	143	245	–	2,5	–	0,35
130	147	161	167,1	1,5	1,1	2	138	144	–	172	173	1,5	1	0,2
	149	175	183,81	2	1	5,5	138	144	–	190	193	2	1	0,3
	175	226	157,9	4	–	6	147	166	153	263	–	3	–	0,35
140	158	173	180	1,5	1,1	2	148	155	–	182	183	1,5	1	0,2
	163	189	197,82	2	1	5,5	150	158	–	200	203	2	1	0,3
	173	212	221,92	3	3	5	153	167	–	236	236	2,5	2,5	0,3
	187	241	168,5	4	–	6,5	157	178	163	283	–	3	–	0,35
150	169	189	196,4	2	1,1	2	159	166	–	201	203	2	1	0,2
	170	198	206,8	2,1	1,1	7	159	165	–	214	217	2	1	0,3
	184	227	236,71	3	3	6	163	178	–	256	256	2,5	2,5	0,3
	202	261	182,5	4	–	6,5	168	192	178	302	–	3	–	0,35
160	180	200	207,2	2	1,1	2,5	169	177	–	211	211	2	1	0,2
	185	215	224,86	2,1	1,1	7	171	180	–	230	233	2	1	0,3
	208	255	266,36	3	3	6	176	201	–	276	276	2,5	2,5	0,3
170	191	211	218	2	1,1	2,5	179	188	–	221	223	2	1	0,2
	198	232	242,85	2,1	1,1	7	181	192	–	249	252	2	1	0,3
	219	269	281,09	4	4	7	189	212	–	295	294	3	3	0,3
	227	291	203,55	4	–	7	187	215	198	342	–	3	–	0,35
180	203	223	232	2	1,1	2,5	189	199	–	241	243	2	1	0,2
	212	248	260,22	2,1	2,1	7	192	206	–	269	269	2	2	0,3
	245	309	221,75	4	–	8	199	233	215	361	–	3	–	0,35

¹⁾ Recommended shaft abutment diameter for axially loaded bearings → Flange support, page 512

6.3 Single row full complement cylindrical roller bearings

d 190 – 340 mm

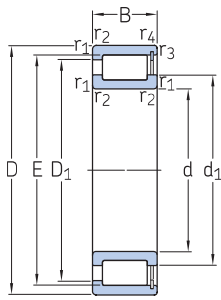

NCF

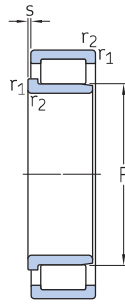

NJG

Principal dimensions			Basic load ratings		Fatigue load limit	Speed ratings		Mass	Designation
d	D	B	C	C ₀		Reference speed	Limiting speed		
mm			kN		kN	r/min		kg	–
190	260	42	440	780	81,5	1 100	1 400	6,5	▶ NCF 2938 CV NCF 3038 CV NCF 2238 V
	290	75	792	1 290	140	1 000	1 300	17	
	340	92	1 250	1 900	196	800	1 000	35,5	
	400	132	2 160	3 000	280	630	800	80	NJG 2338 VH
200	250	24	176	335	32,5	1 100	1 400	2,6	▶ NCF 1840 V NCF 2940 CV NCF 3040 CV
	280	48	528	965	100	1 000	1 300	9,1	
	310	82	913	1 530	160	950	1 200	22,5	
	420	138	2 290	3 200	290	600	750	92	NJG 2340 VH
220	270	24	183	365	34,5	1 000	1 200	2,85	▶ NCF 1844 V NCF 2944 CV NCF 3044 CV
	300	48	550	1 060	106	900	1 200	9,9	
	340	90	1 080	1 800	186	850	1 100	29,5	
	400	108	1 830	2 750	255	700	850	58	NCF 2244 V
	460	145	2 700	3 750	335	530	670	111	NJG 2344 VH
240	300	28	260	510	47,5	900	1 100	4,4	▶ NCF 1848 V NCF 2948 CV NCF 3048 CV
	320	48	583	1 140	114	850	1 100	10,5	
	360	92	1 140	1 960	200	800	1 000	32	
	500	155	3 140	4 400	390	480	600	147	NJG 2348 VH
260	320	28	270	550	50	800	1 000	4,55	▶ NCF 1852 V NCF 2952 CV NCF 3052 CV
	360	60	737	1 430	143	750	950	18	
	400	104	1 540	2 550	250	700	900	46,5	
	540	165	3 580	5 000	430	430	530	177	NJG 2352 VH
280	350	33	341	695	64	750	950	7,1	▶ NCF 1856 V NCF 2956 CV NCF 3056 CV
	380	60	880	1 730	166	700	900	19,5	
	420	106	1 570	2 650	260	670	850	50	
300	380	38	418	850	75	670	850	10	▶ NCF 1860 V NCF 2960 CV NCF 3060 CV
	420	72	1 120	2 200	208	630	800	31	
	460	118	1 900	3 250	300	600	750	65,5	
320	400	38	440	900	80	630	800	10,5	▶ NCF 1864 V NCF 2964 V NCF 3064 CV
	440	72	1 140	2 360	220	600	750	33	
	480	121	1 980	3 450	310	560	700	71	
340	420	38	446	950	83	600	750	11	▶ NCF 1868 V NCF 2968 V NCF 3068 CV
	460	72	1 190	2 500	228	560	700	35	
	520	133	2 380	4 150	355	530	670	95	



▶ Popular item

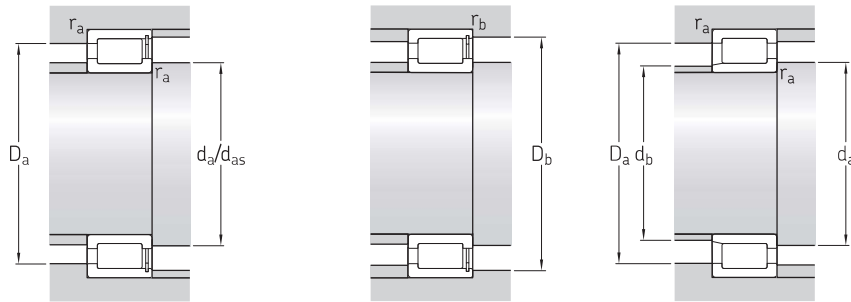

Dimensions							Abutment and fillet dimensions							Calculation factor
d	d ₁ ≈	D ₁ ≈	E, F	r _{1,2} min.	r _{3,4} min.	s max.	d _a min.	d _{as} ¹⁾	d _b max.	D _a max.	D _b max.	r _a max.	r _b max.	k _r
mm							mm							-
190	212	236	244	2	1,1	2	199	208	-	250	252	2	1	0,2
	222	258	269,76	2,1	2,1	8	202	216	-	279	279	2	2	0,3
	243	296	310,68	4	4	7	209	235	-	325	324	3	3	0,3
	250	320	224,544	5	-	8	210	239	222	378	-	4	-	0,35
200	218	231	237,5	1,5	1,1	1,8	207	215	-	243	244	1,5	1	0,1
	226	253	262	2,1	1,5	3	211	222	-	269	271	2	1,5	0,2
	237	275	287,75	2,1	2,1	9	213	230	-	299	299	2	2	0,3
	266	342	238,65	5	-	9	221	252	232	398	-	4	-	0,35
220	238	252	258	1,5	1,1	1,8	227	235	-	263	264	1,5	1	0,1
	247	274	283	2,1	1,5	3	231	243	-	289	291	2	1,5	0,2
	255	298	312,2	3	3	9	233	248	-	327	327	2,5	2,5	0,3
	277	349	366	4	4	8	239	268	-	385	383	3	3	0,3
	295	383	266,7	5	-	10	240	281	259	440	-	4	-	0,35
240	263	279	287	2	1,1	1,8	249	259	-	291	294	2	1	0,1
	267	294	303	2,1	1,5	3	251	263	-	309	311	2	1,5	0,2
	278	321	335,1	3	3	11	254	271	-	347	347	2,5	2,5	0,3
	310	403	287,75	5	-	10	260	295	282	480	-	4	-	0,35
260	283	299	307,2	2	1,1	1,8	269	279	-	311	313	2	1	0,1
	291	323	333,7	2,1	1,5	3,5	271	287	-	348	350	2	1,5	0,2
	304	358	375,97	4	4	11	277	295	-	384	384	3	3	0,3
	349	456	315,9	6	-	11	286	332	308	514	-	5	-	0,35
280	307	325	334	2	1,1	2,5	290	303	-	341	343	2	1	0,1
	314	348	359,1	2,1	1,5	3	291	309	-	368	370	2	1,5	0,2
	319	373	390,3	4	4	11	295	310	-	404	404	3	3	0,3
300	331	353	363	2,1	1,5	3	311	326	-	369	372	2	1,5	0,1
	341	375	390,5	3	3	5	314	334	-	405	405	2,5	2,5	0,2
	355	413	433	4	4	14	315	344	-	445	445	3	3	0,3
320	351	373	383	2,1	1,5	3	331	346	-	389	392	2	1,5	0,1
	359	401	411	3	3	5	333	353	-	427	427	2,5	2,5	0,2
	368	434	449,5	4	4	14	335	359	-	465	465	3	3	0,3
340	371	393	403	2,1	1,5	3	351	366	-	409	412	2	1,5	0,1
	378	421	431	3	3	5	353	373	-	447	447	2,5	2,5	0,2
	395	468	485,65	5	5	14	358	384	-	502	502	4	4	0,3

¹⁾ Recommended shaft abutment diameter for axially loaded bearings → Flange support, page 512

6.3 Single row full complement cylindrical roller bearings

d 360 – 560 mm

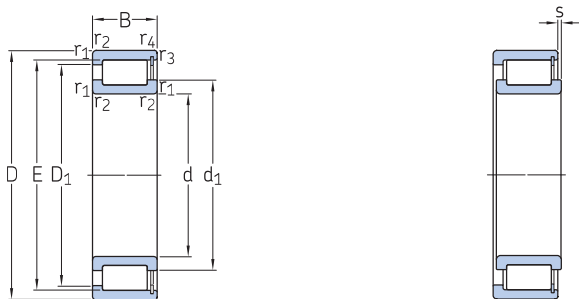

Principal dimensions			Basic load ratings		Fatigue load limit	Speed ratings		Mass	Designation
d	D	B	C	C ₀		Reference speed	Limiting speed		
mm			kN		kN	r/min	kg	–	
360	440	38	402	900	76,5	560	700	11,5	▶ NCF 1872 V
	480	72	1 230	2 600	240	530	670	36,5	▶ NCF 2972 CV
	540	134	2 420	4 300	365	500	630	105	NCF 3072 CV
380	480	46	627	1 290	114	530	670	19,5	▶ NCF 1876 V
	520	82	1 570	3 250	300	500	630	52	▶ NCF 2976 V
	560	135	2 700	5 100	425	480	600	110	NCF 3076 V
400	500	46	627	1 340	118	500	630	20,5	▶ NCF 1880 V
	540	82	1 650	3 450	310	480	600	54,5	▶ NCF 2980 CV
	600	148	2 970	5 500	450	450	560	145	NCF 3080 CV
420	520	46	660	1 430	122	480	600	20,5	▶ NCF 1884 V
	560	82	1 650	3 600	315	450	560	57	▶ NCF 2984 V
	620	150	3 030	5 700	455	430	530	150	NCF 3084 CV
440	540	46	671	1 460	125	450	560	22	▶ NCF 1888 V
	540	60	1 060	2 700	232	450	560	30	NCF 2888 V
	600	95	2 010	4 400	380	430	530	80	▶ NCF 2988 V
460	580	72	1 300	3 050	260	430	530	44	NCF 2892 V/HB1
	620	95	2 050	4 500	390	400	500	83	▶ NCF 2992 V
	680	163	3 690	6 950	540	380	480	195	NCF 3092 CV
480	600	56	935	2 040	170	400	500	35,5	NCF 1896 V
	600	72	1 320	3 150	265	400	500	46	NCF 2896 V
	650	100	2 290	4 900	405	380	480	93	▶ NCF 2996 V
	700	165	3 740	7 200	550	360	450	205	NCF 3096 CV
500	620	56	952	2 120	173	380	480	35,5	▶ NCF 18/500 V
	620	72	1 340	3 350	275	380	480	47	NCF 28/500 V
	670	100	2 380	5 300	430	360	450	100	NCF 29/500 V
	720	167	3 800	7 500	570	360	450	215	NCF 30/500 CV
530	650	56	990	2 240	180	360	450	38,5	▶ NCF 18/530 V
	650	72	1 400	3 450	285	360	450	49,5	NCF 28/530 V
	710	106	2 700	6 000	465	340	430	120	NCF 29/530 V
	780	185	5 230	10 600	780	320	400	300	NCF 30/530 V
560	680	56	1 020	2 360	186	340	430	39	▶ NCF 18/560 V/HB1
	680	72	1 420	3 650	300	340	430	54	▶ NCF 28/560 V
	750	112	3 030	6 700	490	320	400	140	NCF 29/560 V/HB1
	820	195	5 830	11 800	865	300	380	345	NCF 30/560 V

▶ Popular item

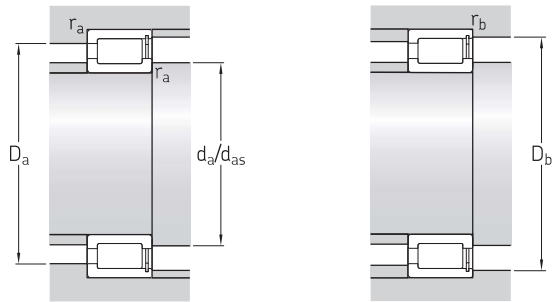

Dimensions							Abutment and fillet dimensions							Calculation factor
d	d ₁ ≈	D ₁ ≈	E, F	r _{1,2} min.	r _{3,4} min.	s max.	d _a min.	d _{as} ¹⁾	d _b max.	D _a max.	D _b max.	r _a max.	r _b max.	k _r
mm							mm							-
360	388	413	418,9	2,1	2,1	3	371	384	-	429	433	2	2	0,1
	404	437	451,5	3	3	5	373	396	-	467	467	2,5	2,5	0,2
	412	486	503,45	5	5	14	378	402	-	522	522	4	4	0,3
380	416	448	458	2,1	2,1	3,5	391	411	-	469	473	2	2	0,1
	427	474	488	4	4	5	395	420	-	505	505	3	3	0,2
	431	504	520,5	5	5	14	398	420	-	542	542	4	4	0,3
400	433	465	475	2,1	2,1	3,5	411	428	-	489	493	2	2	0,1
	449	499	511	4	4	5	415	442	-	525	525	3	3	0,2
	460	540	558	5	5	14	418	449	-	582	582	4	4	0,3
420	457	489	499	2,1	2,1	3,5	431	452	-	509	513	2	2	0,1
	462	512	524	4	4	5	435	455	-	545	545	3	3	0,2
	480	559	577,6	5	5	15	438	469	-	602	602	4	4	0,3
440	474	506	516	2,1	2,1	3,5	451	469	-	529	533	2	2	0,1
	474	508	516	2,1	2,1	3,5	451	469	-	529	533	2	2	0,11
	502	545	565,5	4	4	6	455	492	-	585	585	3	3	0,2
460	501	543	553	3	3	5	473	495	-	567	567	2,5	2,5	0,11
	516	558	579	4	4	6	475	506	-	605	605	3	3	0,2
	522	611	632,97	6	6	16	483	511	-	657	657	5	5	0,3
480	522	561	573,5	3	3	5	493	516	-	587	587	2,5	2,5	0,1
	520	562	573,5	3	3	5	493	515	-	587	587	2,5	2,5	0,11
	538	584	615	5	5	7	498	527	-	632	632	4	4	0,2
	546	628	654	6	6	16	503	532	-	677	677	5	5	0,3
500	542	582	594	3	3	5	513	536	-	607	607	2,5	2,5	0,1
	541	582	594	3	3	2,4	513	536	-	607	607	2,5	2,5	0,11
	553	611	634,5	5	5	7	518	544	-	652	652	4	4	0,2
	565	650	676	6	6	16	523	553	-	697	697	5	5	0,3
530	573	612	624,5	3	3	5	543	567	-	637	637	2,5	2,5	0,1
	572	614	624,5	3	3	5	543	566	-	637	637	2,5	2,5	0,11
	598	648	673	5	5	7	548	587	-	692	692	4	4	0,2
	610	702	732	6	6	16	553	595	-	757	757	5	5	0,3
560	603	643	655	3	3	5	573	597	-	667	667	2,5	2,5	0,1
	606	637	655	3	3	4,3	573	599	-	667	667	2,5	2,5	0,11
	628	682	709	5	5	7	578	615	-	732	732	4	4	0,2
	642	738	770	6	6	16	583	626	-	797	797	5	5	0,3

¹⁾ Recommended shaft abutment diameter for axially loaded bearings → Flange support, page 512

6.3 Single row full complement cylindrical roller bearings

d 600 – 1 120 mm

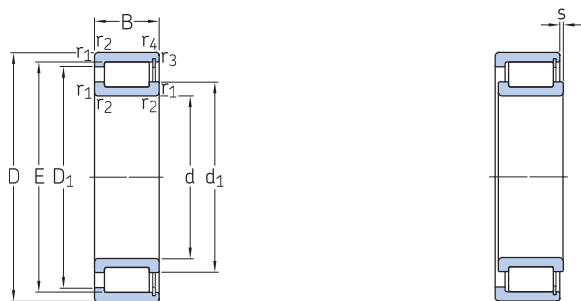

Principal dimensions			Basic load ratings		Fatigue load limit	Speed ratings		Mass	Designation
d	D	B	dynamic	static		Reference speed	Limiting speed		
			C	C ₀	P _u	r/min		kg	–
mm			kN		kN				
600	730	60	1 050	2 550	196	320	400	51,5	▶ NCF 18/600 V NCF 28/600 V/HB1 NCF 29/600 V
	730	78	1 570	4 300	340	320	400	67,5	
	800	118	3 360	7 500	550	300	380	170	
630	780	69	1 250	2 900	232	300	360	72,5	▶ NCF 18/630 V NCF 28/630 V NCF 29/630 V
	780	88	1 940	5 000	390	300	360	92	
	850	128	3 740	8 650	610	280	340	205	
670	820	69	1 300	3 150	245	280	340	74	▶ NCF 18/670 V ▶ NCF 28/670 V NCF 29/670 V
	820	88	1 940	5 300	415	280	340	98	
	900	136	3 910	9 000	630	260	320	245	
710	870	74	1 540	3 750	285	260	320	92,5	NCF 18/710 V NCF 28/710 V NCF 29/710 V
	870	95	2 330	6 300	480	260	320	115	
	950	140	4 290	10 000	695	240	300	275	
750	920	78	1 760	4 300	315	240	300	105	▶ NCF 18/750 V NCF 28/750 V NCF 29/750 V
	920	100	2 640	6 950	520	240	300	139	
	1 000	145	4 460	10 600	710	220	280	313	
800	980	82	1 940	4 800	345	220	280	126	NCF 18/800 V ▶ NCF 28/800 V NCF 29/800 V
	980	106	2 750	7 500	550	220	280	169	
	1 060	150	4 950	12 000	800	200	260	359	
850	1 030	82	2 050	5 200	375	200	260	131	NCF 18/850 V NCF 28/850 V NCF 29/850 V
	1 030	106	2 860	8 000	570	200	260	175	
	1 120	155	5 230	12 700	830	190	240	406	
900	1 090	85	2 240	5 700	405	190	240	154	NCF 18/900 V/HB1 NCF 28/900 V NCF 29/900 V
	1 090	112	3 190	9 150	655	190	240	210	
	1 180	165	5 940	14 600	950	170	220	472	
950	1 150	90	2 420	6 300	425	170	220	185	NCF 18/950 V NCF 28/950 V NCF 29/950 V
	1 150	118	3 410	9 800	655	170	220	240	
	1 250	175	6 600	16 300	1 020	160	200	565	
1 000	1 220	100	2 920	7 500	455	160	200	230	NCF 18/1000 V NCF 28/1000 V NCF 29/1000 V
	1 220	128	4 130	11 600	720	160	200	309	
	1 320	185	7 480	18 600	1 160	150	180	680	
1 120	1 360	106	3 740	9 650	585	130	170	298	NCF 18/1120 V

▶ Popular item

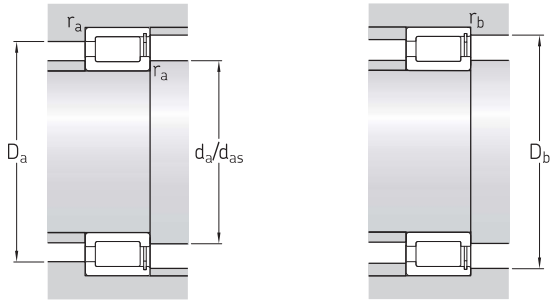

Dimensions							Abutment and fillet dimensions							Calculation factor
d	d ₁ ≈	D ₁ ≈	E, F	r _{1,2} min.	r _{3,4} min.	s max.	d _a min.	d _{as} ¹⁾	d _b max.	D _a max.	D _b max.	r _a max.	r _b max.	k _r
mm							mm							-
600	644	684	696	3	3	7	613	638	-	717	717	2,5	2,5	0,1
	642	685	696	3	3	5,4	613	637	-	717	717	2,5	2,5	0,11
	662	726	754	5	5	7	618	652	-	782	782	4	4	0,2
630	681	725	739	4	4	8	645	674	-	765	765	3	3	0,1
	680	728	741,4	4	4	8	645	674	-	765	765	3	3	0,11
	709	788	807	6	6	8	653	698	-	827	827	5	5	0,2
670	725	769	783	4	4	8	685	718	-	805	805	3	3	0,1
	724	772	783	4	4	8	685	718	-	805	805	3	3	0,11
	748	827	846	6	6	10	693	737	-	877	877	5	5	0,2
710	767	815	831	4	4	8	725	759	-	855	855	3	3	0,1
	766	818	831	4	4	8	725	759	-	855	855	3	3	0,11
	790	876	896	6	6	10	733	761	-	927	927	5	5	0,2
750	811	863	880	5	5	8	768	802	-	902	902	4	4	0,1
	810	867	878	5	5	8	768	799	-	902	902	4	4	0,11
	832	918	938	6	6	11	773	820	-	977	977	5	5	0,2
800	863	922	936	5	5	9	818	855	-	962	962	4	4	0,1
	863	922	936	5	5	10	818	855	-	962	962	4	4	0,11
	891	981	1 002	6	6	11	823	860	-	1 037	1 037	5	5	0,2
850	911	972	986	5	5	9	868	903	-	1 012	1 012	4	4	0,1
	911	972	986	5	5	10	868	903	-	1 012	1 012	4	4	0,11
	943	1 039	1 061	6	6	13	873	914	-	1 097	1 097	5	5	0,2
900	966	1 029	1 044	5	5	9	918	957	-	1 072	1 072	4	4	0,1
	966	1 029	1 044	5	5	10	918	957	-	1 072	1 072	4	4	0,11
	996	1 096	1 120	6	6	13	923	982	-	1 127	1 127	5	5	0,2
950	1 021	1 087	1 103	5	5	10	968	1 012	-	1 132	1 132	4	4	0,1
	1 021	1 087	1 103	5	5	12	968	1 012	-	1 132	1 132	4	4	0,11
	1 048	1 154	1 179	7,5	7,5	14	978	1 033	-	1 222	1 222	6	6	0,2
1 000	1 073	1 148	1 165	6	6	12	1 023	1 063	-	1 197	1 197	5	5	0,1
	1 073	1 148	1 165	6	6	12	1 023	1 063	-	1 197	1 197	5	5	0,11
	1 113	1 226	1 252	7,5	7,5	14	1 028	1 091	-	1 292	1 292	6	6	0,2
1 120	1 206	1 290	1 310	6	6	12	1 143	1 194	-	1 337	1 337	5	5	0,1

¹⁾ Recommended shaft abutment diameter for axially loaded bearings → Flange support, page 512



6.4 Double row full complement cylindrical roller bearings

d 20 – 90 mm

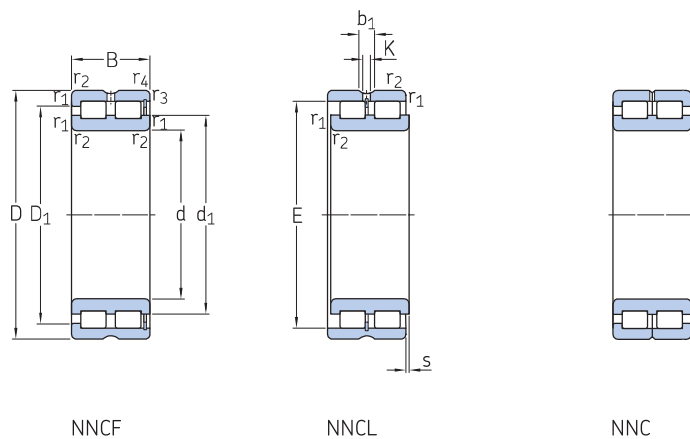

Principal dimensions			Basic load ratings		Fatigue load limit	Speed ratings		Mass	Designation
d	D	B	C	C ₀	P _u	Reference speed	Limiting speed		
mm			kN		kN	r/min		kg	–
20	42	30	52,3	57	6,2	8 500	10 000	0,2	NNCF 5004 CV
25	47	30	59,4	71	7,65	7 000	9 000	0,23	NNCF 5005 CV
30	55	34	73,7	88	10	6 000	7 500	0,35	NNCF 5006 CV
35	62	36	89,7	112	12,9	5 300	6 700	0,46	NNCF 5007 CV
40	68	38	106	140	17	4 800	6 000	0,56	NNCF 5008 CV
45	75	40	112	156	18,3	4 300	5 300	0,71	NNCF 5009 CV
50	80	40	142	196	23,6	4 000	5 000	0,76	NNCF 5010 CV
55	90	46	190	280	34,5	3 400	4 300	1,15	NNCF 5011 CV
60	85	25	78,1	137	14,3	3 600	4 500	0,48	NNCF 4912 CV
	85	25	78,1	137	14,3	3 600	4 500	0,47	NNCL 4912 CV
	85	25	78,1	137	14,3	3 600	4 500	0,49	NNC 4912 CV
	95	46	198	300	36,5	3 400	4 000	1,25	NNCF 5012 CV
65	100	46	209	325	40	3 000	3 800	1,3	NNCF 5013 CV
70	100	30	114	193	22,4	3 000	3 800	0,77	NNCF 4914 CV
	100	30	114	193	22,4	3 000	3 800	0,75	NNCL 4914 CV
	100	30	114	193	22,4	3 000	3 800	0,78	NNC 4914 CV
	110	54	238	345	45	2 800	3 600	1,85	NNCF 5014 CV
75	115	54	251	380	49	2 600	3 200	1,95	NNCF 5015 CV
80	110	30	121	216	25	2 600	3 400	0,87	NNCF 4916 CV
	110	30	121	216	25	2 600	3 400	0,85	NNCL 4916 CV
	110	30	121	216	25	2 600	3 400	0,88	NNC 4916 CV
	125	60	308	455	58,5	2 400	3 000	2,6	NNCF 5016 CV
85	130	60	314	475	60	2 400	3 000	2,7	NNCF 5017 CV
90	125	35	161	300	35,5	2 400	3 000	1,35	NNCF 4918 CV
	125	35	161	300	35,5	2 400	3 000	1,3	NNCL 4918 CV
	125	35	161	300	35,5	2 400	3 000	1,35	NNC 4918 CV
	140	67	369	560	69,5	2 200	2 800	3,6	NNCF 5018 CV

6.4



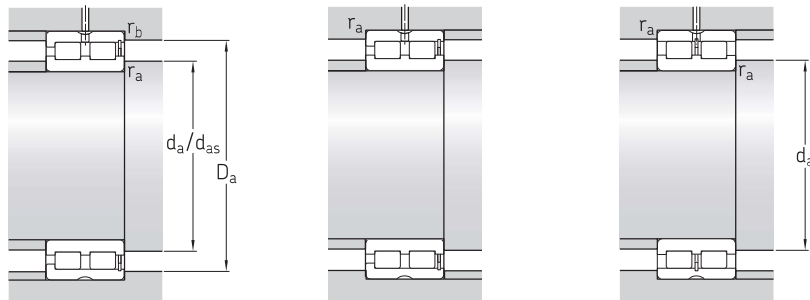

Dimensions									Abutment and fillet dimensions					Calculation factor
d	d ₁ ≈	D ₁ ≈	E	b ₁	K	r _{1,2} min.	r _{3,4} min.	s max.	d _a min.	d _{as} ¹⁾	D _a max.	r _a max.	r _b max.	k _r
mm									mm					
20	28,4	33,2	–	4,5	3	0,6	0,3 ²⁾	1	23,2	25,6	38,7	0,5	0,3	0,5
25	34,5	38,5	–	4,5	3	0,6	0,3 ²⁾	1	28,7	31,5	43,5	0,5	0,3	0,5
30	40	45,5	–	4,5	3	1	0,3 ²⁾	1,5	34,7	37,8	50	1	0,3	0,5
35	45	51,5	–	4,5	3	1	0,3 ²⁾	1,5	40,2	42,6	57	1	0,3	0,5
40	50,5	57,2	–	4,5	3	1	0,3 ²⁾	1,5	44,8	47,7	63	1	0,3	0,5
45	55,3	62,5	–	4,5	3	1	0,3 ²⁾	1,5	51	52,8	70	1	0,3	0,5
50	59	67,5	–	4,5	3	1	0,3 ²⁾	1,5	56	56,7	74	1	0,3	0,5
55	68,5	78,7	–	4,5	3,5	1,1	0,6 ²⁾	1,5	61	64,8	84	1	0,5	0,5
60	70,5	73,5	–	4,5	3,5	1	1	1	65	67,6	80	1	1	0,25
	70,5	–	77,51	4,5	3,5	1	–	1	65	–	80	1	–	0,25
	70,5	73,5	–	4,5	3,5	1	–	–	65	67,6	80	1	–	0,25
	71,5	82	–	4,5	3,5	1,1	0,6 ²⁾	1,5	66	68,9	89	1	0,5	0,5
65	78	88,3	–	4,5	3,5	1,1	0,6 ²⁾	1,5	72	75	94	1	0,5	0,5
70	83	87	–	4,5	3,5	1	1	1	76	79	95	1	1	0,25
	83	–	91,87	4,5	3,5	1	–	1	76	–	95	1	–	0,25
	83	87	–	4,5	3,5	1	–	–	76	79	95	1	–	0,25
	81,5	95	–	5	3,5	1,1	0,6 ²⁾	3	76	79	105	1	0,5	0,5
75	89	103	–	5	3,5	1,1	0,6 ²⁾	3	81	85	109	1	0,5	0,5
80	92	96	–	5	3,5	1	1	1	85	88	105	1	1	0,25
	92	–	100,78	5	3,5	1	–	1	85	–	105	1	–	0,25
	92	96	–	5	3,5	1	–	–	85	88	105	1	–	0,25
	95	111	–	5	3,5	1,1	0,6 ²⁾	3,5	86	91	119	1	0,5	0,5
85	99,5	116	–	5	3,5	1,1	0,6 ²⁾	3,5	91	95	124	1	0,5	0,5
90	103	110	–	5	3,5	1,1	1,1	1,5	96	99	119	1	1	0,25
	103	–	115,2	5	3,5	1,1	–	1,5	96	–	119	1	–	0,25
	103	110	–	5	3,5	1,1	–	–	96	99	119	1	–	0,25
	106	124	–	5	3,5	1,5	1 ²⁾	4	98	102	133	1,5	1	0,5

¹⁾ Recommended shaft abutment diameter for axially loaded bearings → Flange support, page 512

²⁾ Parameter r_{3,4} has either the value specified here or the same value as r_{1,2}.

6.4 Double row full complement cylindrical roller bearings

d 100 – 150 mm

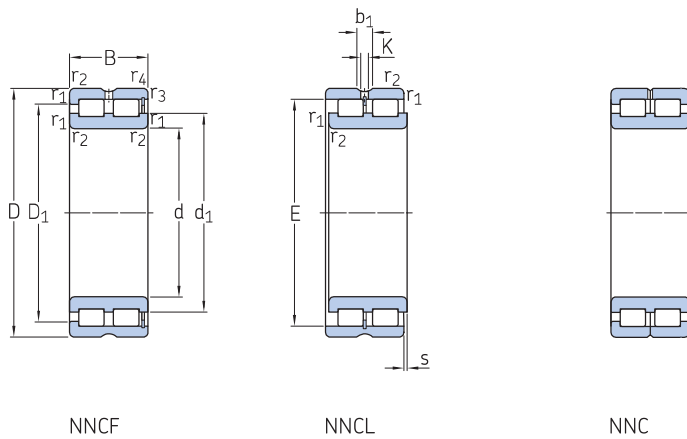

Principal dimensions			Basic load ratings		Fatigue load limit	Speed ratings		Mass	Designation
d	D	B	dynamic C	static C ₀		Reference speed	Limiting speed		
mm			kN		kN	r/min		kg	–
100	140	40	209	400	46,5	2 000	2 600	1,95	NNCF 4920 CV
	140	40	209	400	46,5	2 000	2 600	1,9	NNCL 4920 CV
	140	40	209	400	46,5	2 000	2 600	1,95	NNC 4920 CV
	150	67	391	620	75	2 000	2 600	3,95	NNCF 5020 CV
110	150	40	220	430	49	1 900	2 400	2,1	NNCF 4922 CV
	150	40	220	430	49	1 900	2 400	2,1	NNCL 4922 CV
	150	40	220	430	49	1 900	2 400	2,15	NNC 4922 CV
	170	80	512	800	95	1 800	2 200	6,3	NNCF 5022 CV
120	165	45	242	480	53	1 700	2 200	2,9	NNCF 4924 CV
	165	45	242	480	53	1 700	2 200	2,85	NNCL 4924 CV
	165	45	242	480	53	1 700	2 200	2,95	NNC 4924 CV
	180	80	539	880	104	1 700	2 000	6,75	NNCF 5024 CV
130	180	50	297	530	60	1 600	2 000	3,9	NNCF 4926 CV
	180	50	297	530	60	1 600	2 000	3,8	NNCL 4926 CV
	180	50	297	530	60	1 600	2 000	3,95	NNC 4926 CV
	200	95	765	1 250	143	1 500	1 900	10	NNCF 5026 CV
140	190	50	308	570	63	1 500	1 900	4,15	NNCF 4928 CV
	190	50	308	570	63	1 500	1 900	4,1	NNCL 4928 CV
	190	50	308	570	63	1 500	1 900	4,2	NNC 4928 CV
	210	95	809	1 370	153	1 400	1 800	11	NNCF 5028 CV
150	190	40	255	585	60	1 500	1 800	2,8	NNCF 4830 CV
	190	40	255	585	60	1 500	1 800	2,7	NNCL 4830 CV
	190	40	255	585	60	1 500	1 800	2,9	NNC 4830 CV
	210	60	429	830	91,5	1 400	1 700	6,55	NNCF 4930 CV
	210	60	429	830	91,5	1 400	1 700	6,45	NNCL 4930 CV
	210	60	429	830	91,5	1 400	1 700	6,65	NNC 4930 CV
	225	100	842	1 430	160	1 300	1 700	13,5	NNCF 5030 CV

6.4



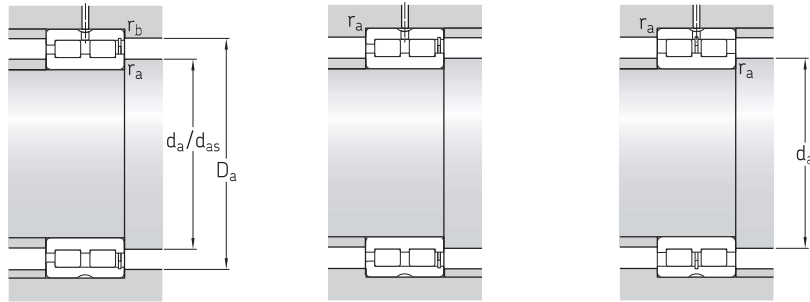

Dimensions									Abutment and fillet dimensions					Calculation factor
d	d ₁ ≈	D ₁ ≈	E	b ₁	K	r _{1,2} min.	r _{3,4} min.	s max.	d _a min.	d _{as} ¹⁾	D _a max.	r _a max.	r _b max.	k _r
mm									mm					
100	116	125	–	5	3,5	1,1	1,1	2	106	111	134	1	1	0,25
	116	–	129,6	5	3,5	1,1	–	2	106	–	134	1	–	0,25
	116	125	–	5	3,5	1,1	–	–	106	111	134	1	–	0,25
	116	134	–	6	3,5	1,5	1 ²⁾	4	108	113	143	1,5	1	0,5
110	125	134	–	6	3,5	1,1	1,1	2	116	121	144	1	1	0,25
	125	–	138,2	6	3,5	1,1	–	2	116	–	144	1	–	0,25
	125	134	–	6	3,5	1,1	–	–	116	121	144	1	–	0,25
	127	149	–	6	3,5	2	1 ²⁾	5	120	124	161	2	1	0,5
120	139	148	–	6	3,5	1,1	1,1	3	126	136	159	1	1	0,25
	139	–	153,55	6	3,5	1,1	–	3	126	–	159	1	–	0,25
	139	148	–	6	3,5	1,1	–	–	126	133	159	1	–	0,25
	139	160	–	6	3,5	2	1 ²⁾	5	130	130	171	2	1	0,5
130	149	160	–	6	3,5	1,5	1,5	4	138	144	173	1,5	1,5	0,25
	149	–	165,4	6	3,5	1,5	–	4	138	–	173	1,5	–	0,25
	149	160	–	6	3,5	1,5	–	–	138	144	173	1,5	–	0,25
	149	175	–	7	4	2	1 ²⁾	5	141	145	190	2	1	0,5
140	160	170	–	6	3,5	1,5	1,5	4	148	154	182	1,5	1,5	0,25
	160	–	175,9	6	3,5	1,5	–	4	148	–	182	1,5	–	0,25
	160	170	–	6	3,5	1,5	–	–	148	154	182	1,5	–	0,25
	163	189	–	7	4	2	1 ²⁾	5	151	157	200	2	1	0,5
150	166	173	–	7	4	1,1	1,1	2	156	161	184	1	1	0,2
	166	–	178,3	7	4	1,1	–	2	156	–	184	1	–	0,2
	166	173	–	7	4	1,1	–	–	156	161	184	1	–	0,2
	171	187	–	7	4	2	2	4	159	165	201	2	2	0,25
	171	–	192,77	7	4	2	–	4	159	–	201	2	–	0,25
	171	187	–	7	4	2	–	–	159	165	201	2	–	0,25
	170	198	–	7	4	2	1,1 ²⁾	6	160	166	217	2	1	0,5

¹⁾ Recommended shaft abutment diameter for axially loaded bearings → Flange support, page 512

²⁾ Parameter r_{3,4} has either the value specified here or the same value as r_{1,2}.

6.4 Double row full complement cylindrical roller bearings

d 160 – 190 mm

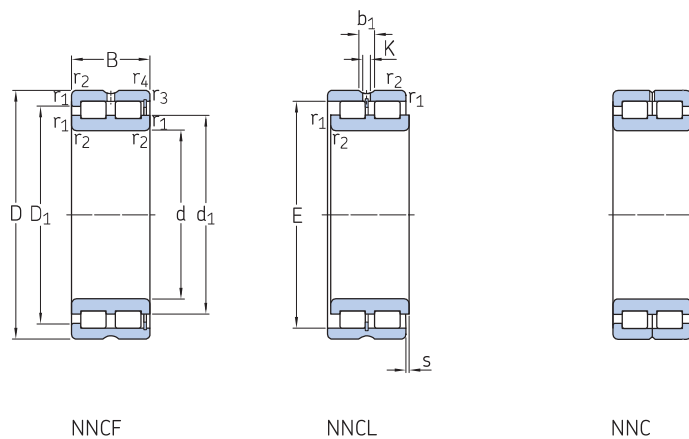

Principal dimensions			Basic load ratings		Fatigue load limit	Speed ratings		Mass	Designation
d	D	B	C	C ₀	P _u	Reference speed	Limiting speed		
mm			kN		kN	r/min		kg	–
160	200	40	260	610	62	1 400	1 700	3	NNCF 4832 CV
	200	40	260	610	62	1 400	1 700	2,9	NNCL 4832 CV
	200	40	260	610	62	1 400	1 700	3,1	NNC 4832 CV
	220	60	446	915	96,5	1 300	1 600	6,9	NNCF 4932 CV
	220	60	446	915	96,5	1 300	1 600	6,8	NNCL 4932 CV
	220	60	446	915	96,5	1 300	1 600	7	NNC 4932 CV
	240	109	952	1 600	180	1 200	1 500	16	NNCF 5032 CV
170	215	45	286	655	65,5	1 300	1 600	4	NNCF 4834 CV
	215	45	286	655	65,5	1 300	1 600	3,9	NNCL 4834 CV
	215	45	286	655	65,5	1 300	1 600	4	NNC 4834 CV
	230	60	457	950	100	1 200	1 500	7,2	NNCF 4934 CV
	230	60	457	950	100	1 200	1 500	7,1	NNCL 4934 CV
	230	60	457	950	100	1 200	1 500	7,35	NNC 4934 CV
	260	122	1 230	2 120	236	1 100	1 400	23	NNCF 5034 CV
180	225	45	297	695	69,5	1 200	1 500	4,2	NNCF 4836 CV
	225	45	297	695	69,5	1 200	1 500	4,1	NNCL 4836 CV
	225	45	297	695	69,5	1 200	1 500	4,3	NNC 4836 CV
	250	69	594	1 220	127	1 100	1 400	10,5	NNCF 4936 CV
	250	69	594	1 220	127	1 100	1 400	10,5	NNCL 4936 CV
	250	69	594	1 220	127	1 100	1 400	11	NNC 4936 CV
	280	136	1 420	2 500	270	1 100	1 300	30,5	NNCF 5036 CV
190	240	50	358	750	76,5	1 100	1 400	5,5	NNCF 4838 CV
	240	50	358	750	76,5	1 100	1 400	5,3	NNCL 4838 CV
	240	50	358	750	76,5	1 100	1 400	5,65	NNC 4838 CV
	260	69	605	1 290	132	1 100	1 400	11	NNCF 4938 CV
	260	69	605	1 290	132	1 100	1 400	11	NNCL 4938 CV
	260	69	605	1 290	132	1 100	1 400	11	NNC 4938 CV
	290	136	1 470	2 600	280	1 000	1 300	31,5	NNCF 5038 CV

6.4



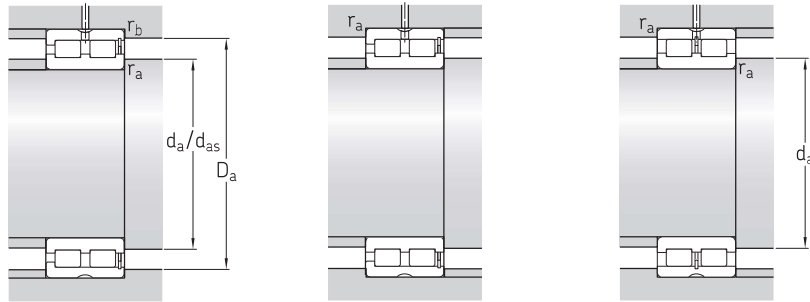

Dimensions									Abutment and fillet dimensions					Calculation factor
d	d ₁ ≈	D ₁ ≈	E	b ₁	K	r _{1,2} min.	r _{3,4} min.	s max.	d _a min.	d _{as} ¹⁾	D _a max.	r _a max.	r _b max.	k _r
mm									mm					
160	174	182	–	7	4	1,1	1,1	2	166	170	194	1	1	0,2
	174	–	186,9	7	4	1,1	–	2	166	–	194	1	–	0,2
	174	182	–	7	4	1,1	–	–	166	170	194	1	–	0,2
	185	200	–	7	4	2	2	4	170	177	211	2	2	0,25
	185	–	206,16	7	4	2	–	4	170	–	211	2	–	0,25
	185	200	–	7	4	2	–	–	170	177	211	2	–	0,25
	185	216	–	7	4	2,1	1,1 ²⁾	6	171	178	231	2	1	0,5
170	187	196	–	7	4	1,1	1,1	3	176	182	209	1	1	0,2
	187	–	201,3	7	4	1,1	–	3	176	–	209	1	–	0,2
	187	196	–	7	4	1,1	–	–	176	182	209	1	–	0,2
	194	209	–	7	4	2	2	4	180	187	220	2	2	0,25
	194	–	215,08	7	4	2	–	4	180	–	220	2	–	0,25
	194	209	–	7	4	2	–	–	180	187	220	2	–	0,25
	198	232	–	7	4	2,1	1,1	6	181	193	251	2	1	0,5
180	200	209	–	7	4	1,1	1,1	3	186	193	219	1	1	0,2
	200	–	214,1	7	4	1,1	–	3	186	–	219	1	–	0,2
	200	209	–	7	4	1,1	–	–	186	193	219	1	–	0,2
	206	224	–	7	4	2	2	4	190	198	240	2	2	0,25
	206	–	230,5	7	4	2	–	4	190	–	240	2	–	0,25
	206	224	–	7	4	2	–	–	190	198	240	2	–	0,25
	212	248	–	8	4	2,1	2,1	8	191	206	270	2	2	0,5
190	209	219	–	7	4	1,5	1,5	4	197	203	233	1,5	1,5	0,2
	209	–	225	7	4	1,5	–	4	197	–	233	1,5	–	0,2
	209	219	–	7	4	1,5	–	–	197	203	233	1,5	–	0,2
	216	233	–	7	4	2	2	4	201	208	250	2	2	0,25
	216	–	240,7	7	4	2	–	4	201	–	250	2	–	0,25
	216	233	–	7	4	2	–	–	201	208	250	2	–	0,25
	222	258	–	8	4	2,1	2,1	8	202	216	280	2	2	0,5

¹⁾ Recommended shaft abutment diameter for axially loaded bearings → Flange support, page 512
²⁾ Parameter r_{3,4} has either the value specified here or the same value as r_{1,2}.

6.4 Double row full complement cylindrical roller bearings

d 200 – 260 mm

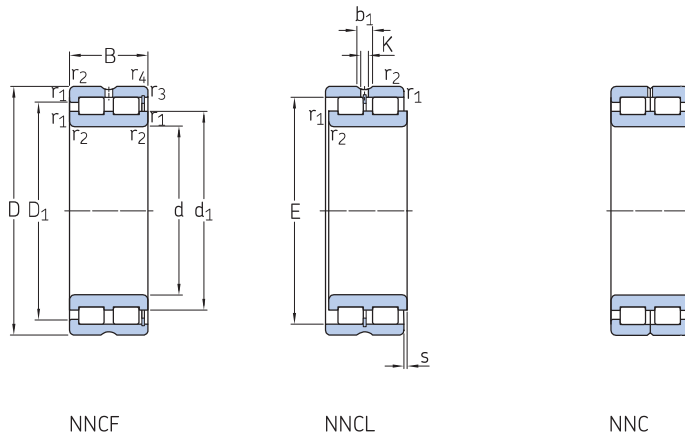

Principal dimensions			Basic load ratings		Fatigue load limit	Speed ratings		Mass	Designation
d	D	B	C	C ₀	P _u	Reference speed	Limiting speed		
mm			kN		kN	r/min		kg	–
200	250	50	369	800	80	1 100	1 400	5,8	NNCF 4840 CV
	250	50	369	800	80	1 100	1 400	5,7	NNCL 4840 CV
	250	50	369	800	80	1 100	1 400	5,9	NNC 4840 CV
	280	80	704	1 500	153	1 000	1 300	15,5	NNCF 4940 CV
	280	80	704	1 500	153	1 000	1 300	15,5	NNCL 4940 CV
	280	80	704	1 500	153	1 000	1 300	16	NNC 4940 CV
	310	150	1 680	3 050	320	950	1 200	41	NNCF 5040 CV
220	270	50	380	865	85	1 000	1 200	6,3	NNCF 4844 CV
	270	50	380	865	85	1 000	1 200	6,2	NNCL 4844 CV
	270	50	380	865	85	1 000	1 200	6,4	NNC 4844 CV
	300	80	737	1 600	160	950	1 200	17	NNCF 4944 CV
	300	80	737	1 600	160	950	1 200	17	NNCL 4944 CV
	300	80	737	1 600	160	950	1 200	17	NNC 4944 CV
	340	160	2 010	3 600	375	850	1 100	52,5	NNCF 5044 CV
240	300	60	539	1 290	125	900	1 100	9,9	NNCF 4848 CV
	300	60	539	1 290	125	900	1 100	9,8	NNCL 4848 CV
	300	60	539	1 290	125	900	1 100	10	NNC 4848 CV
	320	80	781	1 760	173	850	1 100	18,5	NNCF 4948 CV
	320	80	781	1 760	173	850	1 100	18	NNCL 4948 CV
	320	80	781	1 760	173	850	1 100	18,5	NNC 4948 CV
	360	160	2 120	3 900	400	800	1 000	56	NNCF 5048 CV
260	320	60	561	1 400	132	800	1 000	11	NNCF 4852 CV
	320	60	561	1 400	132	800	1 000	10,5	NNCL 4852 CV
	320	60	561	1 400	132	800	1 000	11	NNC 4852 CV
	360	100	1 170	2 550	245	750	950	31,5	NNCF 4952 CV
	360	100	1 170	2 550	245	750	950	31	NNCL 4952 CV
	360	100	1 170	2 550	245	750	950	32	NNC 4952 CV
	400	190	2 860	5 100	500	700	900	85,5	NNCF 5052 CV

6.4



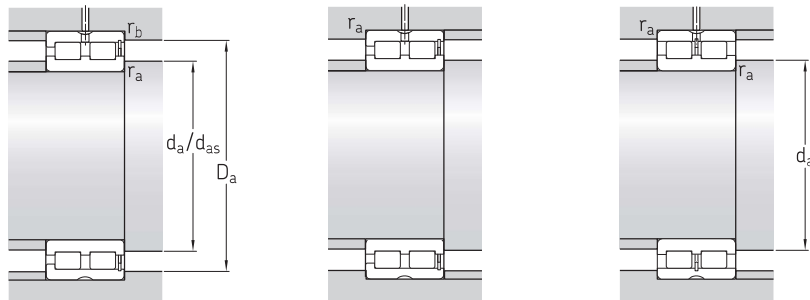

Dimensions									Abutment and fillet dimensions					Calculation factor
d	d ₁ ≈	D ₁ ≈	E	b ₁	K	r _{1,2} min.	r _{3,4} min.	s max.	d _a min.	d _{as} ¹⁾	D _a max.	r _a max.	r _b max.	k _r
mm									mm					
200	220	230	–	7	4	1,5	1,5	4	207	213	243	1,5	1,5	0,2
	220	–	235,5	7	4	1,5	–	4	207	–	243	1,5	–	0,2
	220	230	–	7	4	1,5	–	–	207	213	243	1,5	–	0,2
	233	252	–	8	4	2,1	2,1	5	211	219	269	2	2	0,25
	233	–	259,34	8	4	2,1	–	5	211	–	269	2	–	0,25
	233	252	–	8	4	2,1	–	–	211	221	269	2	–	0,25
	237	275	–	8	4	2,1	2,1	9	212	224	300	2	2	0,5
220	241	251	–	7	4	1,5	1,5	4	227	233	263	1,5	1,5	0,2
	241	–	256,5	7	4	1,5	–	4	227	–	263	1,5	–	0,2
	241	251	–	7	4	1,5	–	–	227	233	263	1,5	–	0,2
	248	269	–	8	4	2,1	2,1	5	232	240	288	2	2	0,25
	248	–	276,52	8	4	2,1	–	5	232	–	288	2	–	0,25
	248	269	–	8	4	2,1	–	–	232	240	288	2	–	0,25
	255	302	–	8	6	3	3	9	235	245	327	2,5	2,5	0,5
240	261	275	–	8	4	2	2	4	249	254	292	2	2	0,2
	261	–	281,9	8	4	2	–	4	249	–	292	2	–	0,2
	261	275	–	8	4	2	–	–	249	254	292	2	–	0,2
	271	291	–	8	4	2,1	2,1	5	251	261	308	2	2	0,25
	271	–	299,46	8	4	2,1	–	5	251	–	308	2	–	0,25
	271	291	–	8	4	2,1	–	–	251	261	308	2	–	0,25
	276	324	–	9,4	5	3	3	9	256	267	347	2,5	2,5	0,5
260	283	297	–	8	4	2	2	4	269	276	311	2	2	0,2
	283	–	304,2	8	4	2	–	4	269	–	311	2	–	0,2
	283	297	–	8	4	2	–	–	269	276	311	2	–	0,2
	295	321	–	9,4	5	2,1	2,1	6	272	283	349	2	2	0,25
	295	–	331,33	9,4	5	2,1	–	6	272	–	349	2	–	0,25
	295	321	–	9,4	5	2,1	–	–	272	283	349	2	–	0,25
	302	362	–	9,4	5	4	4	10	278	291	384	3	3	0,5

¹⁾ Recommended shaft abutment diameter for axially loaded bearings → Flange support, page 512

6.4 Double row full complement cylindrical roller bearings

d 280 – 340 mm

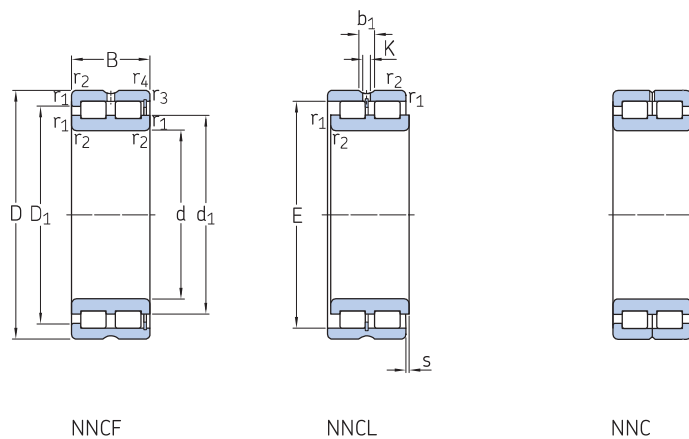

Principal dimensions			Basic load ratings		Fatigue load limit	Speed ratings		Mass	Designation	
d	D	B	C	C ₀	P _u	Reference speed	Limiting speed			
mm			kN		kN	r/min		kg	–	
280	350	69	737	1 860	173	750	950	16	NNCF 4856 CV	
	350	69	737	1 860	173	750	950	15,5	NNCL 4856 CV	
	350	69	737	1 860	173	750	950	16	NNC 4856 CV	
	380	100	1 210	2 700	255	700	900	33,5	NNCF 4956 CV	
	380	100	1 210	2 700	255	700	900	33	NNCL 4956 CV	
	380	100	1 210	2 700	255	700	900	34	NNC 4956 CV	
	420	190	2 920	5 300	520	670	850	90,5	NNCF 5056 CV	
	300	380	80	858	2 120	196	700	850	22,5	NNCF 4860 CV
		380	80	858	2 120	196	700	850	22	NNCL 4860 CV
380		80	858	2 120	196	700	850	23	NNC 4860 CV	
420		118	1 680	3 750	355	670	800	52,5	NNCF 4960 CV	
420		118	1 680	3 750	355	670	800	52	NNCL 4960 CV	
420		118	1 680	3 750	355	670	800	53	NNC 4960 CV	
460		218	3 520	6 550	600	600	750	130	NNCF 5060 CV	
320		400	80	897	2 280	208	630	800	23,5	NNCF 4864 CV
		400	80	897	2 280	208	630	800	23	NNCL 4864 CV
	400	80	897	2 280	208	630	800	24	NNC 4864 CV	
	440	118	1 760	4 050	375	600	750	55,5	NNCF 4964 CV	
	440	118	1 760	4 050	375	600	750	55	NNCL 4964 CV	
	440	118	1 760	4 050	375	600	750	56	NNC 4964 CV	
	480	218	3 690	6 950	620	560	700	135	NNCF 5064 CV	
	340	420	80	913	2 400	216	600	750	25	NNCF 4868 CV
		420	80	913	2 400	216	600	750	25,5	NNCL 4868 CV
420		80	913	2 400	216	600	750	25,5	NNC 4868 CV	
460		118	1 790	4 250	390	560	700	58,5	NNCF 4968 CV	
460		118	1 790	4 250	390	560	700	58	NNCL 4968 CV	
460		118	1 790	4 250	390	560	700	59	NNC 4968 CV	
520		243	4 400	8 300	710	530	670	185	NNCF 5068 CV	

6.4



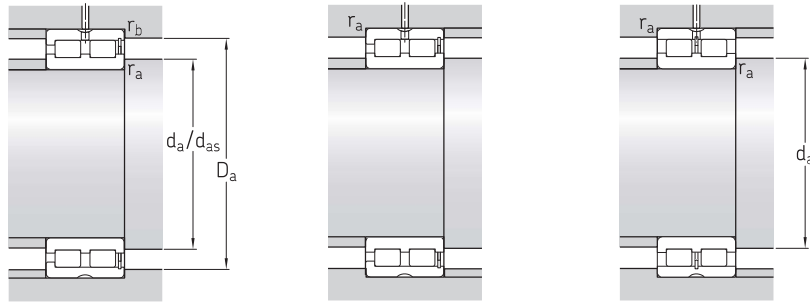

Dimensions									Abutment and fillet dimensions					Calculation factor
d	d ₁ ≈	D ₁ ≈	E	b ₁	K	r _{1,2} min.	r _{3,4} min.	s max.	d _a min.	d _{as} ¹⁾	D _a max.	r _a max.	r _b max.	k _r
mm									mm					
280	308	326	–	8	4	2	2	4	290	299	341	2	2	0,2
	308	–	332,4	8	4	2	–	4	290	–	341	2	–	0,2
	308	326	–	8	4	2	–	–	290	299	341	2	–	0,2
	317	343	–	9,4	5	2,1	2,1	6	293	312	368	2	2	0,25
	317	–	353,34	9,4	5	2,1	–	6	293	–	368	2	–	0,25
	317	343	–	9,4	5	2,1	–	–	293	305	368	2	–	0,25
	318	372	–	9,4	5	4	4	10	299	310	404	3	3	0,5
300	330	349	–	9,4	5	2,1	2,1	6	310	319	370	2	2	0,2
	330	–	356,7	9,4	5	2,1	–	6	310	–	370	2	–	0,2
	330	349	–	9,4	5	2,1	–	–	310	319	370	2	–	0,2
	340	374	–	9,4	5	3	3	6	315	335	406	2,5	2,5	0,25
	340	–	385,51	9,4	5	3	–	6	315	–	406	2,5	–	0,25
	341	374	–	9,4	5	3	–	–	315	328	406	2,5	–	0,25
	352	418	–	9,4	5	4	4	9	319	336	443	3	3	0,5
320	352	372	–	9,4	5	2,1	2,1	6	331	341	390	2	2	0,2
	352	–	379,7	9,4	5	2,1	–	6	331	–	390	2	–	0,2
	352	372	–	9,4	5	2,1	–	–	331	341	390	2	–	0,2
	368	401	–	9,4	5	3	3	6	336	352	425	2,5	2,5	0,25
	368	–	412,27	9,4	5	3	–	6	336	–	425	2,5	–	0,25
	368	401	–	9,4	5	3	–	–	336	352	425	2,5	–	0,25
	370	434	–	9,4	5	4	4	9	339	360	462	3	3	0,5
340	368	390	–	9,4	5	2,1	2,1	6	351	360	410	2	2	0,2
	368	–	396,9	9,4	5	2,1	–	6	351	–	410	2	–	0,2
	369	369	–	9,4	5	2,1	–	–	551	360	410	2	–	0,2
	385	419	–	9,4	5	3	3	6	356	371	445	2,5	2,5	0,25
	385	–	430,11	9,4	5	3	–	6	356	–	445	2,5	–	0,25
	385	419	–	9,4	5	3	–	–	356	371	445	2,5	–	0,25
	395	468	–	9,4	5	5	5	11	362	384	500	4	4	0,5



¹⁾ Recommended shaft abutment diameter for axially loaded bearings → Flange support, page 512

6.4 Double row full complement cylindrical roller bearings

d 360 – 400 mm

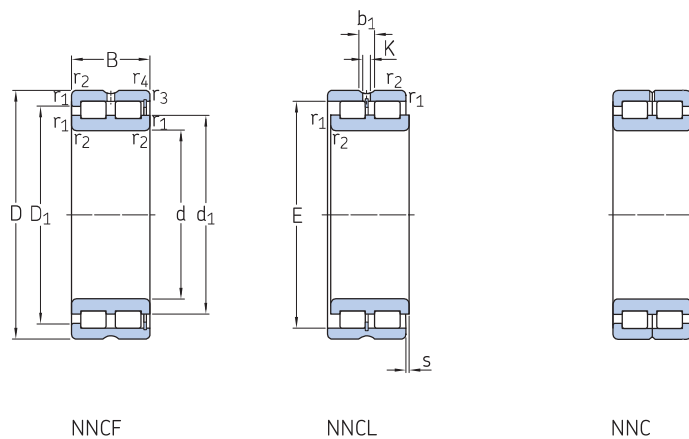

Principal dimensions			Basic load ratings		Fatigue load limit	Speed ratings		Mass	Designation
d	D	B	C	C ₀	P _u	Reference speed	Limiting speed		
mm			kN		kN	r/min		kg	–
360	440	80	935	2 550	224	560	700	26,5	NNCF 4872 CV
	440	80	935	2 550	224	560	700	26	NNCL 4872 CV
	440	80	935	2 550	224	560	700	27	NNC 4872 CV
	480	118	1 830	4 500	405	530	670	61,5	NNCF 4972 CV
	480	118	1 830	4 500	405	530	670	61	NNCL 4972 CV
	480	118	1 830	4 500	405	530	670	62	NNC 4972 CV
	540	243	4 180	8 650	735	500	630	195	NNCF 5072 CV
380	480	100	1 400	3 650	315	530	670	45	NNCF 4876 CV
	480	100	1 400	3 650	315	530	670	44	NNCL 4876 CV
	480	100	1 400	3 650	315	530	670	45,5	NNC 4876 CV
	520	140	2 380	5 700	500	500	630	91,5	NNCF 4976 CV
	520	140	2 380	5 700	500	500	630	90,5	NNCL 4976 CV
	520	140	2 380	5 700	500	500	630	92,5	NNC 4976 CV
	560	243	4 680	9 150	750	480	600	200	NNCF 5076 CV
400	500	100	1 420	3 750	325	500	630	46	NNCF 4880 CV
	500	100	1 420	3 750	325	500	630	46	NNCL 4880 CV
	500	100	1 420	3 750	325	500	630	46,5	NNC 4880 CV
	540	140	2 420	6 000	520	480	600	95,5	NNCF 4980 CV
	540	140	2 420	6 000	520	480	600	94,5	NNCL 4980 CV
	540	140	2 420	6 000	520	480	600	96,5	NNC 4980 CV
	600	272	5 500	11 000	900	450	560	270	NNCF 5080 CV

6.4



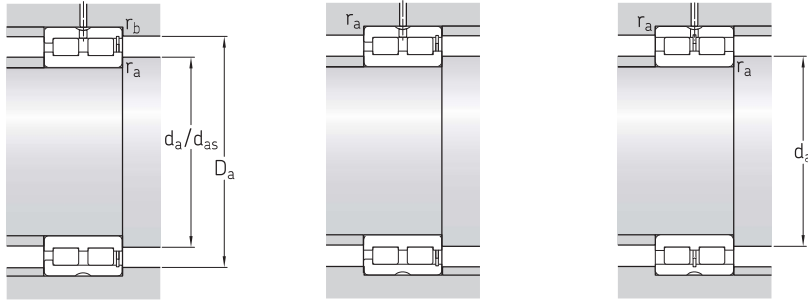

Dimensions									Abutment and fillet dimensions					Calculation factor
d	d ₁ ≈	D ₁ ≈	E	b ₁	K	r _{1,2} min.	r _{3,4} min.	s max.	d _a min.	d _{as} ¹⁾	D _a max.	r _a max.	r _b max.	k _r
mm									mm					
360	391	413	–	9,4	5	2,1	2,1	6	371	381	429	2	2	0,2
	391	–	419,8	9,4	5	2,1	–	6	371	–	429	2	–	0,2
	391	413	–	9,4	5	2,1	–	–	371	381	429	2	–	0,2
	404	437	–	9,4	5	3	3	6	375	390	464	2,5	2,5	0,25
	404	–	447,95	9,4	5	3	–	6	375	–	464	2,5	–	0,25
	404	437	–	9,4	5	3	–	–	375	390	464	2,5	–	0,25
	412	486	–	9,4	5	5	5	11	383	402	519	4	4	0,5
380	419	447	–	9,4	5	2,1	2,1	6	391	405	469	2	2	0,2
	419	–	455,8	9,4	5	2,1	–	6	391	–	469	2	–	0,2
	419	447	–	9,4	5	2,1	–	–	391	405	469	2	–	0,2
	430	469	–	9,4	5	4	4	7	398	414	502	3	3	0,25
	430	–	481,35	9,4	5	4	–	7	398	–	502	3	–	0,25
	430	469	–	9,4	5	4	–	–	398	414	502	3	–	0,25
	485	531	–	9,4	5	5	5	11	403	417	539	4	4	0,5
400	434	462	–	9,4	5	2,1	2,1	6	411	423	488	2	2	0,2
	434	–	470,59	9,4	5	2,1	–	6	411	–	488	2	–	0,2
	434	462	–	9,4	5	2,1	–	–	411	423	488	2	–	0,2
	451	489	–	9,4	5	4	4	7	418	435	521	3	3	0,25
	451	–	501,74	9,4	5	4	–	7	418	–	521	3	–	0,25
	451	489	–	9,4	5	4	–	–	418	435	521	3	–	0,25
	460	540	–	9,4	5	5	5	11	424	442	578	4	4	0,5



¹⁾ Recommended shaft abutment diameter for axially loaded bearings → Flange support, page 512

6.5 Sealed double row full complement cylindrical roller bearings

d 20 – 140 mm

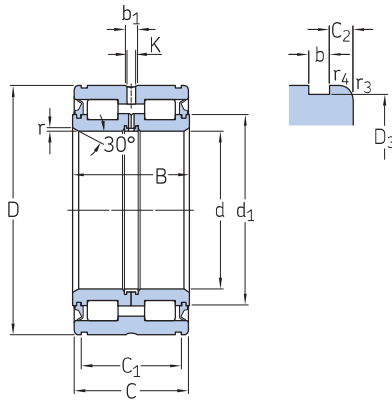

Principal dimensions				Basic load ratings		Fatigue load limit	Limiting speed	Mass	Designation
d	D	B	C	dynamic	static				
				C_0	P_u				
mm				kN	kN	r/min	kg	–	
20	42	30	29	45,7	55	5,7	3 400	0,2	▶ NNF 5004 ADB-2LSV
25	47	30	29	50,1	65,5	6,8	3 000	0,24	▶ NNF 5005 ADB-2LSV
30	55	34	33	57,2	75	7,8	2 600	0,37	▶ NNF 5006 ADB-2LSV
35	62	36	35	70,4	98	10,6	2 200	0,48	▶ NNF 5007 ADB-2LSV
40	68	38	37	85,8	116	13,2	2 000	0,56	▶ NNF 5008 ADB-2LSV
45	75	40	39	102	146	17	1 800	0,7	▶ NNF 5009 ADB-2LSV
50	80	40	39	108	160	18,6	1 700	0,76	▶ NNF 5010 ADB-2LSV
55	90	46	45	128	193	22,8	1 500	1,2	▶ NNF 5011 ADB-2LSV
60	95	46	45	134	208	25	1 400	1,25	▶ NNF 5012 ADB-2LSV
65	100	46	45	138	224	26,5	1 300	1,35	▶ NNF 5013 ADB-2LSV
70	110	54	53	187	285	34,5	1 200	1,85	▶ NNF 5014 ADB-2LSV
75	115	54	53	224	310	40	1 100	1,95	▶ NNF 5015 ADB-2LSV
80	125	60	59	251	415	53	1 000	2,7	▶ NNF 5016 B-2LS
85	130	60	59	270	430	55	1 000	2,85	▶ NNF 5017 B-2LS
90	140	67	66	319	550	69,5	900	3,7	▶ NNF 5018 B-2LS
95	145	67	66	330	570	71	900	3,9	▶ NNF 5019 B-2LS
100	150	67	66	336	570	68	850	3,95	▶ NNF 5020 B-2LS
110	170	80	79	413	695	81,5	750	6,45	▶ NNF 5022 B-2LS
120	180	80	79	429	750	86,5	700	6,9	▶ NNF 5024 B-2LS
130	190	80	79	446	815	91,5	670	7,3	▶ 319426 B-2LS
	200	95	94	616	1 040	120	630	10,5	▶ NNF 5026 B-2LS
140	200	80	79	468	865	96,5	630	8	▶ 319428 DA-2LS
	210	95	94	644	1 120	127	600	11	▶ NNF 5028 B-2LS

▶ Popular item

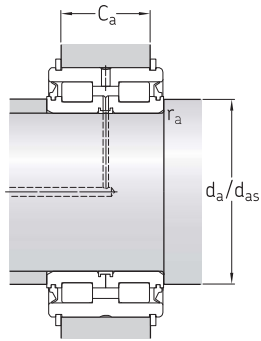

Dimensions										Abutment and fillet dimensions ¹⁾					Calculation factor k_r	Associated snap rings ²⁾	
d	d_1 ≈	D_3	C_{a1} +0,2	C_2	b	b_1	K	r min.	$r_{3,4}$ min.	d_a min.	d_{as} ³⁾	C_{a1} -0,2	C_{a2} -0,2	r_a max.		Seeger	DIN 471
mm										mm					-	-	
20	30,6	40,2	24,7	2,15	1,8	6,5	3,5	0,5	0,3	24	28,8	21,5	21	0,3	0,4	SW 42	42x1.75
25	35,4	45,2	24,7	2,15	1,8	6,5	3,5	0,5	0,3	29	33,6	21,5	21	0,3	0,4	SW 47	47x1.75
30	40,6	53	28,2	2,4	2,1	7,5	4,5	0,5	0,3	34	38,7	25	24	0,3	0,4	SW 55	55x2
35	46,1	60	30,2	2,4	2,1	7,5	4,5	0,5	0,3	39	44	27	26	0,3	0,4	SW 62	62x2
40	51,4	65,8	32,2	2,4	2,7	7,5	4,5	0,8	0,6	44	49,2	28	27	0,4	0,4	SW 68	68x2.5
45	57	72,8	34,2	2,4	2,7	8,5	4,5	0,8	0,6	49	54,7	30	29	0,4	0,4	SW 75	75x2.5
50	61,8	77,8	34,2	2,4	2,7	8,5	4,5	0,8	0,6	54	59,5	30	29	0,4	0,4	SW 80	80x2.5
55	68,6	87,4	40,2	2,4	3,2	8,5	4,5	1	0,6	60	66,1	35	34	0,6	0,4	SW 90	90x3
60	73,7	92,4	40,2	2,4	3,2	9,5	5	1	0,6	65	71,2	35	34	0,6	0,4	SW 95	95x3
65	78,8	97,4	40,2	2,4	3,2	9,5	5	1	0,6	70	76,3	35	34	0,6	0,4	SW 100	100x3
70	84,5	107,1	48,2	2,4	4,2	9,5	5	1	0,6	75	82	43	40	0,6	0,4	SW 110	110x4
75	90	112,1	48,2	2,4	4,2	9,5	5	1	0,6	80	87	43	40	0,6	0,4	SW 115	115x4
80	97	122,1	54,2	2,4	4,2	6	3,5	1,5	0,6	86	94,3	49	46	1	0,4	SW 125	125x4
85	101	127,1	54,2	2,4	4,2	6	3,5	1,5	0,6	91	100	49	46	1	0,4	SW 130	130x4
90	109	137	59,2	3,4	4,2	6	3,5	1,5	0,6	96	106	54	51	1	0,4	SW 140	140x4
95	113	142	59,2	3,4	4,2	6	3,5	1,5	0,6	101	110	54	51	1	0,4	SW 145	145x4
100	118	147	59,2	3,4	4,2	6	3,5	1,5	0,6	106	115	54	51	1	0,4	SW 150	150x4
110	132	167	70,2	4,4	4,2	6	3,5	1,8	0,6	117	128	65	62	1,5	0,4	SW 170	170x4
120	141	176	71,2	3,9	4,2	6	3,5	1,8	0,6	127	138	65	63	1,5	0,4	SW 180	180x4
130	151	186	71,2	3,9	4,2	6	3,5	1,8	0,6	137	147	65	63	1,5	0,4	SW 190	190x4
	155	196	83,2	5,4	4,2	7	4	1,8	0,6	137	150	77	75	1,5	0,4	SW 200	200x4
140	160	196	71,2	3,9	4,2	7	4	1,8	0,6	147	156	65	63	1	0,4	SW 200	200x4
	167	206	83,2	5,4	5,2	7	4	1,8	0,6	147	162	77	73	1,5	0,4	SW 210	210x5

¹⁾ The values for C_{a1} apply for SW snap rings, the values for C_{a2} for snap rings in accordance with DIN 471.

²⁾ Snap rings are not supplied by SKF.

³⁾ Recommended shaft abutment diameter for axially loaded bearings → Flange support, page 512

6.5 Sealed double row full complement cylindrical roller bearings

d 150 – 280 mm

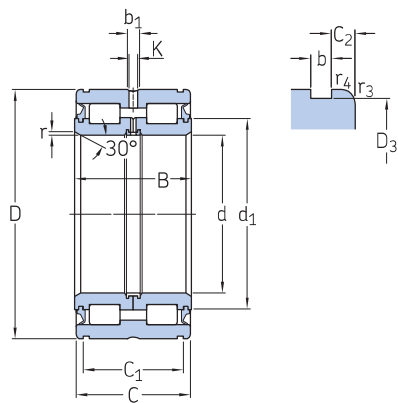

Principal dimensions				Basic load ratings		Fatigue load limit	Limiting speed	Mass	Designation
d	D	B	C	dynamic	static				
					C_0	P_u			
mm				kN		kN	r/min	kg	–
150	210	80	79	484	915	100	600	8,4	319430 B-2LS
	225	100	99	748	1 290	143	560	13,5	▶ NNF 5030 B-2LS
160	220	80	79	501	1 000	106	530	8,8	319432 DA-2LS
	240	109	108	781	1 400	153	500	16,5	NNF 5032 B-2LS
170	230	80	79	512	1 060	110	530	9,2	319434 B-2LS
	260	122	121	1 010	1 800	193	480	22,5	▶ NNF 5034 B-2LS
180	240	80	79	528	1 100	114	480	9,8	319436 DA-2LS
	280	136	135	1 170	2 120	228	450	31	NNF 5036 B-2LS
190	260	80	79	550	1 180	120	450	12,5	319438 DA-2LS
	290	136	135	1 190	2 200	236	430	31,5	NNF 5038 B-2LS
200	270	80	79	583	1 370	137	430	13	319440 B-2LS
	310	150	149	1 450	2 900	300	400	42	NNF 5040 B-2LS
220	300	95	94	880	1 860	190	380	19	319444 B-2LS
	340	160	159	1 610	3 100	315	360	54	NNF 5044 B-2LS
240	320	95	94	952	2 040	200	360	20	319448 B-2LS
	360	160	159	1 680	3 350	335	340	57,5	NNF 5048 B-2LS
260	340	95	94	990	2 160	212	340	22	319452 B-2LS
	400	190	189	2 420	4 650	455	300	86	NNF 5052 B-2LS
280	420	190	189	2 550	5 000	490	280	91	NNF 5056 B-2LS

6.5



▶ Popular item

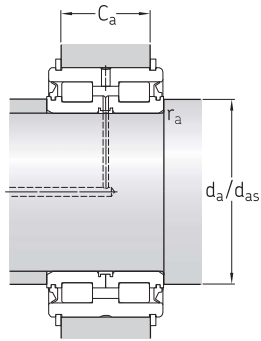

Dimensions										Abutment and fillet dimensions ¹⁾					Calculation factor k_r	Associated snap rings ²⁾	
d	d_1 ≈	D_3	C_{a1} +0,2	C_2	b	b_1	K	r min.	$r_{3,4}$ min.	d_a min.	d_{as} ³⁾	C_{a1} -0,2	C_{a2} -0,2	r_a max.		Seeger	DIN 471
mm										mm					-	-	
150	170	206	71,2	3,9	5,2	7	4	1,8	0,6	157	166	65	61	1,5	0,4	SW 210	210x5
	177	221	87,2	5,9	5,2	7	4	2	0,6	157	172	81	77	2	0,4	SW 225	225x5
160	184	216	71,2	3,9	5,2	7	4	1,8	0,6	167	180	65	61	1	0,4	SW 220	220x5
	191	236	95,2	6,4	5,2	7	4	2	0,6	167	186	89	85	2	0,4	SW 240	240x5
170	194	226	71,2	3,9	5,2	7	4	1,8	0,6	177	190	65	61	1,5	0,4	SW 230	230x5
	203	254	107,2	6,9	5,2	7	4	2	0,6	177	197	99	97	2	0,4	SW 260	260x5
180	203	236	71,2	3,9	5,2	7	4	1,8	0,6	187	199	65	61	1	0,4	SW 240	240x5
	220	274	118,2	8,4	5,2	8	4	2	0,6	187	214	110	108	2	0,4	SW 280	280x5
190	218	254	73,2	2,9	5,2	7	4	1,8	0,6	197	214	65	63	1	0,4	SW 260	260x5
	228	284	118,2	8,4	5,2	8	4	2	0,6	197	222	110	108	2	0,4	SW 290	290x5
200	227	264	73,2	2,9	5,2	7	4	1,8	0,6	207	223	65	63	1,5	0,4	SW 270	270x5
	245	304	128,2	10,4	6,3	8	4	2	0,6	207	239	120	116	2	0,4	SW 310	310x6
220	250	295	83,2	5,4	5,2	8	6	1,8	1	227	246	75	73	1,5	0,4	SW 300	300x5
	263	334	138,2	10,4	6,3	9,5	6	2	1	227	256	130	126	2	0,4	SW 340	340x6
240	269	314	83,2	5,4	6,3	8	6	1,8	1	247	265	75	71	1,5	0,4	SW 320	320x6
	282	354	138,2	10,4	6,3	9,5	6	2	1	247	275	130	126	2	0,4	SW 360	360x6
260	291	334	83,2	5,4	6,3	8	6	1,8	1	267	286	75	71	1,5	0,4	SW 340	340x6
	309	394	162,2	13,4	6,3	9,5	6	2	1,1	268	300	154	150	2	0,4	SW 400	400x6
280	333	413	163,2	12,9	7,3	9,5	6	2	1,1	288	324	154	149	2	0,4	SW 420	420x7



¹⁾ The values for C_{a1} apply for SW snap rings, the values for C_{a2} for snap rings in accordance with DIN 471.
²⁾ Snap rings are not supplied by SKF.
³⁾ Recommended shaft abutment diameter for axially loaded bearings → Flange support, page 512